

GOGATRAY Mittenabhängung / central suspension

Passend für M8 und M10 / fits for M8 and M10

Material	Grösse	Gewicht kg/Stk.	VPE Stk.	ArtNr	€/Stk.
material	size	weight	PU		/pc.
E.G.	M8-M10	0,032	20	06-67010046	0,79
BYCRO	M8-M10	0,029	20	06-67020046	0,91
H.D.G.	M8-M10	0,031	20	06-67030046	1,27
S.S. 316	M8-M10	0,03	20	06-67060046	3,37

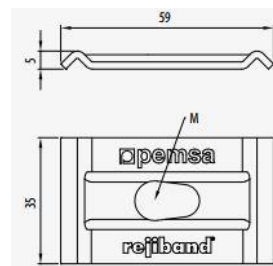

GOGATRAY Click-Mittenabhängung / click central suspension

Material	Grösse	Gewicht kg/Stk.	VPE Stk.	ArtNr	€/Stk.
material	size	weight	PU		/pc.
E.G.	M8	0,032	20	06-67010043	1,72
BYCRO	M8	0,029	20	06-67020043	1,72
H.D.G.	M8	0,031	20	06-67030043	3,19
S.S. 316	M8	0,03	20	06-67060043	3,46

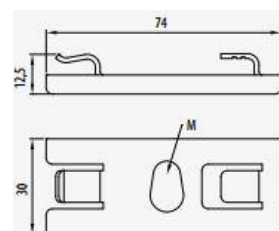

GOGATRAY Leichte Deckenbefestigung / lightweight ceiling mounting

passt für Gitterkanäle Höhe 35 & 60 mm bzw. Breite 60 & 100 & 150 mm (ausgenommen 35 x 60 mm)
fits for grid channels with 35 & 60mm (height) or 60 & 100 & 150 mm (width) (except 35 x 60 mm)

Material	Gewicht kg/Stk.	VPE Stk.	ArtNr	€/Stk.
material	weight	PU		/pc.
E.G.	0,094	36	06-62016020	4,45
BYCHRO	0,094	36	06-62026020	a.A.
H.D.G.	0,094	36	06-62036020	6,05

a. A. = auf Anfrage / upon request

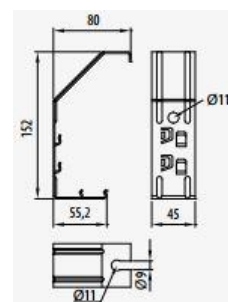
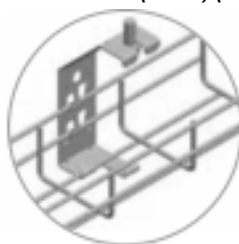

GOGATRAY Deckenbefestigung / ceiling mounting

Material	Gewicht kg/Stk.	max. Belastung (SWL) kg	VPE Stk.	ArtNr	€/Stk.
material	weight	max. load	PU		/pc.
P.G.	0,094	275	10	06-67030060	3,01

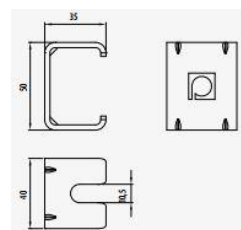

GOGATRAY Verstellbare Deckenbefestigung / adjustable ceiling mounting

Material	Gewicht kg/Stk.	max. Belastung (SWL) kg	VPE Stk.	ArtNr	€/Stk.
material	weight	max. load	PU		/pc.
H.D.G.	0,15	127	1	06-67030061	5,75

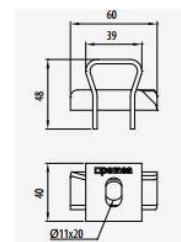

Preise gültig ab 01.01.2024 exkl. MwSt., freibleibend, Auftragsrabatt auf Anfrage /
prices are valid from 01.01.2024 excl. VAT, subject to change, discounts upon request
sonst. Konditionen siehe www.gogatec.com/AGB.pdf, techn. Änderungen vorbehalten /
terms & conditions can be found on our website: www.gogatec.com/AGB.pdf; error, technical modifications and variations are reserved

GOGATRAY Konsolenhalter OMEGA S-Plus / console holder

Material	Abmessung mm	Gewicht kg/Stk.	max. Belastung (SWL) kg	VPE Stk.	ArtNr	€ /Stk.
material	dimension	weight	max. load	PU		/pc.
P.G.	100	0,18	160	10	06-63022104	3,13
	200	0,23	160	10	06-63022204	4,09
	300	0,34	160	10	06-63022304	5,15
	400	0,43	390	10	06-63022404	6,59
	500	0,53	390	10	06-63022504	7,55
H.D.G.	600	0,63	390	10	06-63022604	8,57
	100	0,18	160	10	06-63032104	4,42
	200	0,25	160	10	06-63032204	6,92
	300	0,35	160	10	06-63032304	9,08
	400	0,45	390	10	06-63032404	11,04
	500	0,56	390	10	06-63032504	13,23
	600	0,66	390	10	06-63032604	15,70

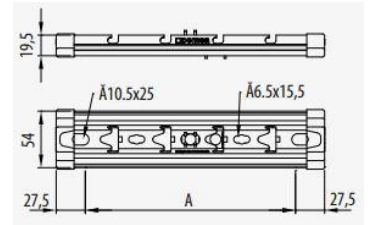
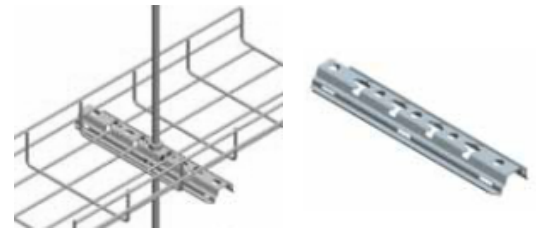

Einschließlich Sicherheitsanschlag

GOGATRAY Gewindemuffe M8 / threaded sleeve

Material	Gewicht kg/Stk.	VPE Stk.	ArtNr	€ /Stk.
material	weight	PU		/pc.
BYCRO	0,016	50	06-67020067	1,57

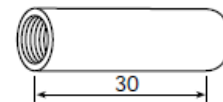

GOGATRAY Gewindestange M6/M8/M10 / threaded rod

Material	Abmessungen mm	Gewicht kg/Stk.	VPE Stk.	ArtNr	€ /Stk.
material	dimensions	weight	PU		/pc.
E.G.	M6x500	0,12	50	06-67010140	2,44
	M6x1000	0,24	50	06-67010141	2,44
BYCRO	M6x500	0,12	50	06-67020140	a.A.
	M6x1000	0,24	50	06-67020141	a.A.
	M8x500	0,16	50	06-67020044	2,68
	M8x1000	0,32	50	06-67020045	3,67
	M10x1000	0,49	50	06-67020145	6,95
S.S. 316	M6x1000	0,24	50	06-67060141	25,50
	M8x500	0,16	50	06-67060044	22,91
	M8x1000	0,32	50	06-67060045	27,75
	M10x1000	0,49	50	06-67060145	33,86

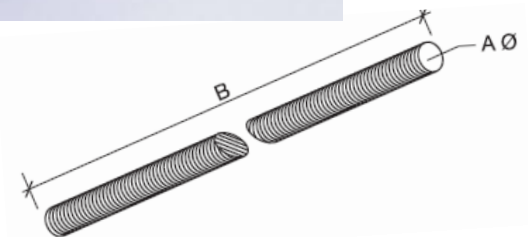

a. A. = auf Anfrage / upon request

Materialien und Korrosionsbeständigkeit (nach BS-EN 61537):

Materials and corrosion resistance (according to BS EN 61537):

Material	Materialbezeichnung	Beständig/h
material	material	resistant/h
P.G.	Sendzimirgalvanisiert nach / <i>sendzimir galvanized to</i> UNE EN 10346	190
H.D.G.	Feuerverzinkt nach / <i>hot-dip galvanized to</i> BS-EN ISO 10346	660
S.S. 304	Edelstahl / <i>stainless steel</i> AISI 304	>850
S.S. 316	Edelstahl / <i>stainless steel</i> AISI 316	>850

Preise gültig ab 01.01.2024 exkl. MwSt., freibleibend, Auftragsrabatt auf Anfrage /

prices are valid from 01.01.2024 excl. VAT, subject to change, discounts upon request

sonst. Konditionen siehe www.gogatec.com/AGB.pdf, techn. Änderungen vorbehalten /

terms & conditions can be found on our website: www.gogatec.com/AGB.pdf; error, technical modifications and variations are reserved

GOGATRAY E90-R-PLUS Verbinder / connector

Für E90 Installation mit OMEGA R-PLUS Konsole / for E90 mounting with OMEGA R-PLUS console

Material	Gewicht kg/Stk.	VPE Stk.	ArtNr	€/Stk.
material	weight	PU		/pc.
H.D.G.	0,15	15	06-62035001	3,79

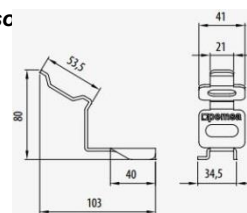

GOGATRAY E90-S-PLUS Verbinder / connector

Für E90 Installation mit S-PLUS Konsole / for E90 mounting with S-PLUS console

Material	Gewicht kg/Stk.	VPE Stk.	ArtNr	€/Stk.
material	weight	PU		/pc.
H.D.G.	0,15	60	06-62031090	3,46

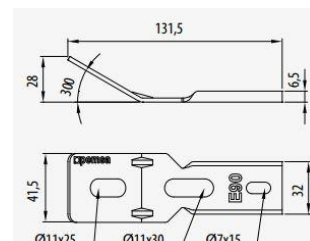
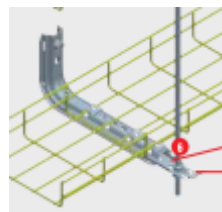

GOGATRAY Trägerklammer / beam clamp

Material	Gewicht kg/Stk.	VPE Stk.	ArtNr	€/Stk.
material	weight	PU		/pc.
BYCRO	0,34	1	06-67020048	11,61

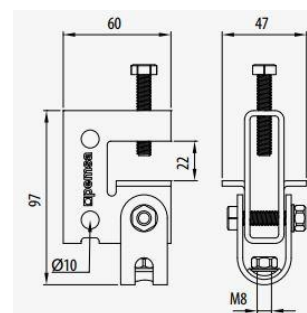
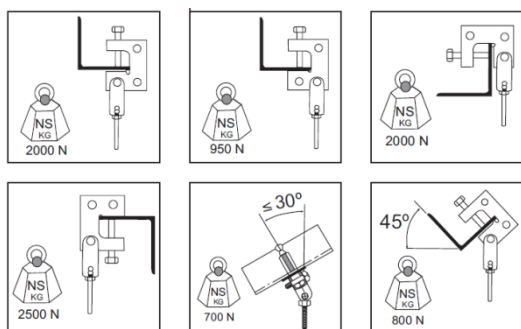

GOGATRAY Waagrechte Aufhängungshalterung / horizontal mount bracket

Material	Abmessung mm	Gewicht kg/Stk.	max. Belastung (SWL) kg	VPE Stk.	ArtNr	€/Stk.
material	dimension	weight	max. load	PU		/pc.
Passiviert / passivated	1,5-5	0,05	65	100	06-68000721	2,89
	4,0-10	0,05	65	100	06-68000722	3,55

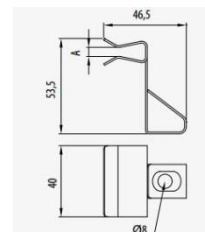

GOGATRAY Senkrechte Aufhängungshalterung / vertical mount bracket

Material	Abmessung mm	Gewicht kg/Stk.	max. Belastung (SWL) kg	VPE Stk.	ArtNr	€/Stk.
material	dimension	weight	max. load	PU		/pc.
Passiviert / passivated	1,5-5	0,04	65	100	06-68000731	3,22
	4,0-10	0,04	65	100	06-68000732	3,22



Materialien und Korrosionsbeständigkeit (nach BS-EN 61537):

Materials and corrosion resistance (according to BS EN 61537):

Material	Materialbezeichnung	Beständig/h
material	material	resistant/h
P.G.	Sendzimirgalvanisiert nach / sendzimir galvanized to UNE EN 10346	190
H.D.G.	Feuerverzinkt nach / hot-dip galvanized to BS-EN ISO 10346	660
S.S. 304	Edelstahl / stainless steel AISI 304	>850
S.S. 316	Edelstahl / stainless steel AISI 316	>850

Preise gültig ab 01.01.2024 exkl. MwSt., freibleibend, Auftragsrabatt auf Anfrage /

prices are valid from 01.01.2024 excl. VAT, subject to change, discounts upon request

sonst. Konditionen siehe www.gogatec.com/AGB.pdf, techn. Änderungen vorbehalten /

terms & conditions can be found on our website: www.gogatec.com/AGB.pdf; error, technical modifications and variations are reserved

GOGATRAY Deckenkonsole Omega S-Plus / overhead console

Material	Abmessung mm	Gewicht kg/Stk.	max. Belastung (SWL) kg	VPE Stk.	ArtNr	€/Stk.
material	dimension	weight	max. load	PU		/pc.
P.G.	100	0,42	33	4	06-62022104	6,17
	150	0,62	36	4	06-62022154	6,91
	200	0,67	29	4	06-62022204	8,15
	300	0,82	25	4	06-62022304	9,26
	400	0,94	18	4	06-62022404	11,04
H.D.G.	100	0,44	33	4	06-62032104	8,93
	150	0,66	36	4	06-62032154	12,39
	200	0,72	29	4	06-62032204	14,22
	300	0,86	25	4	06-62032304	16,00
	400	0,99	18	4	06-62032404	18,13
S.S. 304	100	0,56	33	4	06-62052104	29,41
	150	0,62	36	4	06-62052154	31,54
	200	0,69	29	4	06-62052204	37,31
	300	0,82	25	4	06-62052304	42,12
	400	0,94	18	4	06-62052404	43,51
S.S. 316	100	0,56	33	4	06-62062104	a.A.
	150	0,62	36	4	06-62062154	a.A.
	200	0,69	29	4	06-62062204	a.A.
	300	0,82	25	4	06-62062304	a.A.
	400	0,94	18	4	06-62062404	a.A.

Einschließlich Sicherheitsanschlag

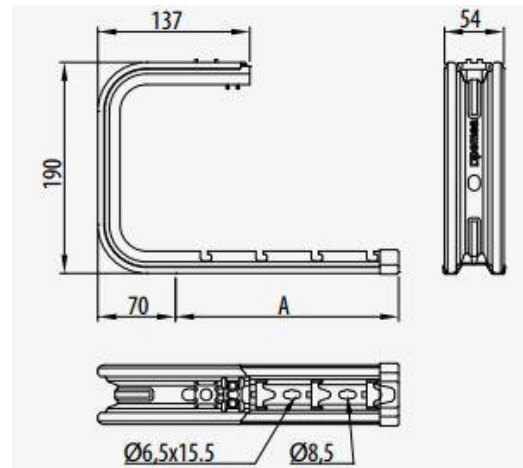

a. A. = auf Anfrage / upon request

GOGATRAY Profil Omega S-Plus / channel

**Zum Konfektionieren vor Ort und für mehrreihige Montagen
for terminating on site and for multi-row assemblies**

Material	Länge m	Gewicht kg/Stk.	VPE Stk.	ArtNr	€/Stk.
material	dimension	weight	PU		/pc.
P.G.	1	1,2	1	06-67020110	16,72
	2	2,4	1	06-67020111	35,42
	3	3,6	1	06-67020112	52,80
H.D.G.	1	1,3	1	06-67030110	26,64
	2	2,6	1	06-67030111	57,80
	3	3,9	1	06-67030112	86,40

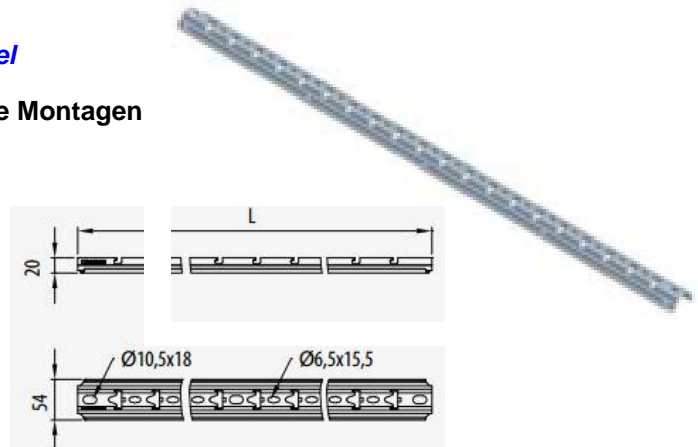

**Materialien und Korrosionsbeständigkeit (nach BS-EN 61537):
Materials and corrosion resistance (according to BS EN 61537):**

Material	Materialbezeichnung	Beständig/h
material	material	resistant/h
P.G.	Sendzimirgalvanisiert nach / sendzimir galvanized to UNE EN 10346	190
H.D.G.	Feuerverzinkt nach / hot-dip galvanized to BS-EN ISO 10346	660
S.S. 304	Edelstahl / stainless steel AISI 304	>850
S.S. 316	Edelstahl / stainless steel AISI 316	>850

Preise gültig ab 01.01.2024 exkl. MwSt., freibleibend, Auftragsrabatt auf Anfrage /
prices are valid from 01.01.2024 excl. VAT, subject to change, discounts upon request
sonst. Konditionen siehe www.gogatec.com/AGB.pdf, techn. Änderungen vorbehalten /
terms & conditions can be found on our website: www.gogatec.com/AGB.pdf; error, technical modifications and variations are reserved

GOGATRAY Verstärkter Hängestiel 41x41 / reinforced suspended support

Material	Abmessung mm	Gewicht kg/Stk.	VPE Stk.	ArtNr	€/Stk.
material	dimension	weight	PU		/pc.
H.D.G.	500	1,51	1	06-67030660	30,01
	1000	2,47	1	06-67030661	41,31

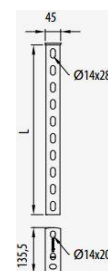

GOGATRAY Doppelter Verstärkter Hängestiel 41x41 / double reinforced suspended support

Material	Abmessung mm	Gewicht kg/Stk.	VPE Stk.	ArtNr	€/Stk.
material	dimension	weight	PU		/pc.
H.D.G.	500	2,48	1	06-67030662	49,82
	1000	4,4	1	06-67030663	87,20

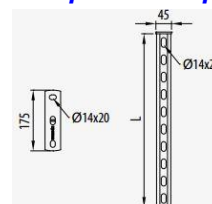

GOGATRAY Verstärkte Pendelschiene / reinforced swing rail

Material	Abmessung mm	Gewicht kg/Stk.	VPE Stk.	ArtNr	€/Stk.
material	dimension	weight	PU		/pc.
P.G.	500	0,87	1	06-67030646	a.A.
	1000	1,76	1	06-67030647	a.A.

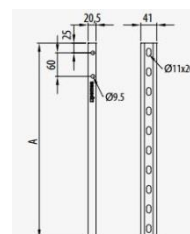

a. A. = auf Anfrage / upon request

GOGATRAY Verstärkter Pendelaufhängung / reinforced pendulum suspension

Material	Gewicht kg/Stk.	VPE Stk.	ArtNr	€/Stk.
material	weight	PU		/pc.
P.G.	0,57	1	06-67030645	a.A.

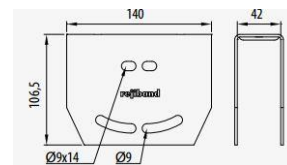

a. A. = auf Anfrage / upon request

GOGATRAY Winkelbefestigung / angle attachment

Material	Gewicht kg/Stk.	VPE Stk.	ArtNr	€/Stk.
material	weight	PU		/pc.
E.B.	0,18	10	06-67020051	6,20

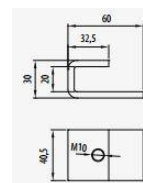

**Materialien und Korrosionsbeständigkeit (nach BS-EN 61537):
Materials and corrosion resistance (according to BS EN 61537):**

Material	Materialbezeichnung	Beständig/h
material	material	resistant/h
P.G.	Sendzimirgalvanisiert nach / sendzimir galvanized to UNE EN 10346	190
H.D.G.	Feuerverzinkt nach / hot-dip galvanized to BS-EN ISO 10346	660
S.S. 304	Edelstahl / stainless steel AISI 304	>850
S.S. 316	Edelstahl / stainless steel AISI 316	>850

Preise gültig ab 01.01.2024 exkl. MwSt., freibleibend, Auftragsrabatt auf Anfrage /
prices are valid from 01.01.2024 excl. VAT, subject to change, discounts upon request
sonst. Konditionen siehe www.gogatec.com/AGB.pdf, techn. Änderungen vorbehalten /
terms & conditions can be found on our website: www.gogatec.com/AGB.pdf; error, technical modifications and variations are reserved