

Aufsnappbar auf DIN-Hutschiene TS35 / snappable on DIN rail TS35
Querverbindung steckbar / pluggable cross connection

Querverbindung steckbar / pluggable cross connection

Isolierkörper / insulating part: Polyamid 6.6
Verbindungssteg / connecting web: Messing / brass
Zugbügelklemme und Schraube / box clamp and screw: Stahl verzinkt, gelb chromatisiert / galvanised steel, yellow chromated
Zulassungen / approvals: Kema EX II GD EEx e II 03ATEX2118U
Kriechstromfestigkeit / comparative tracking: IEC 112: CTI > 600, VDE 0303: KB > 600

GOGATERM EURO RK grau / grey 2,5 – 6mm²

Nennquerschnitt (mm ²) / nominal cross section	2,5	4	6
Typ EURO RK	2,5/35	4/35	5/35
Klemmenbreite (mm) / clamping width	5	6	6
Flexible Leiter (mm ²) / flexible conductors	0,5-4	0,5-6	0,5-6
Feste Leiter (mm ²) / solid conductors	0,5-4	0,5-6	0,5-6
Leiter m. Aderendhülsen (mm ²) / cond. W. CES	0,5-2,5	0,5-4	0,5-4
AWG	24-12	24-10	24-10
Kaliber / caliber	A3	A4	A5
Anzahl anschließb. Leiter / numb. of connectable cond.	2x1,5/4x1	4x1,5	2x4
Leiterraufnahmeraum (mm) / connecting capacity	3,6x2,6	4x3,3	5x4
Leiter abisolieren (mm) / conductor stripping	9	9	9
Schraubengewinde / screw thread	M 2,6	M 3	M 3
max. Anzugsdrehmoment (Nm) / max tightening torque	0,5	0,6	0,6
Mittelgewinde / central thread	M 2,5	M 3	M 3
Normen / norms			
SEV	750V/24A	800V/25A	-
VDE	1000V/24A	1000V/32A	-
RINA	800V/24A	800V/32A	-
UL	600V/20A	600V/30A	600V/41A
CSA	600V/25A	600V/25A	-
Abmessungen (mm) / dimensions	5x44x36	6x44x36	6x44x36
Verpackungseinheit / PU	100	100	100
ArtNr	44-43408	44-43409	44-43407
€/Stk. /pc.	0,76	0,76	1,24



Feindrätig mit Aderendhülse - ein Nennquerschnitt kleiner! / stranded with cord end sleeve - smaller nominal cross-section!

GOGATERM EURO RK bunt / colored 2,5 – 6mm²

Nennquerschnitt / nominal cross section	2,5	4
blau / blue	44-43408BL	44-43409BL
schwarz / black	44-43408BK	44-43409BK
braun / brown	44-43408BR	44-43409BR
€/Stk. /pc.	1,00	0,86
grün-gelb / green-yellow	44-43408E	44-43409E
€/Stk. /pc.	1,22	1,28

ACHTUNG! / ATTENTION!
 Keine Verbindung zur Hutschiene!
 Siehe ERDUNGSKLEMMEN! /
 No connection to the DIN rail!
 See grounding clamps!

Preise gültig ab 01.01.2024 exkl. MwSt., freibleibend, Auftragsrabatt auf Anfrage /
 prices are valid from 01.01.2024 excl. VAT, subject to change, discounts upon request
 sonst. Konditionen siehe www.gogatec.com/AGB.pdf, techn. Änderungen vorbehalten /
 terms & conditions can be found on our website: www.gogatec.com/AGB.pdf; error, technical modifications and variations are reserved

Aufschnappbar auf DIN-Hutschiene TS35 / snappable on DIN rail TS35
Querverbindung schraubbar / screwing cross connection



Isolierkörper / insulating part: Polyamid 6.6

ENEL DV27 SCCR

Verbindungssteg / connecting web: Messing / brass

Zugbügelklemme und Schraube / box clamp and screw: Stahl verzinkt, gelb chromatisiert /
galvanised steel, yellow chromated

Zulassungen / approvals: EN60947-7-1, EN60068-2-11

Kriechstromfestigkeit / comparative tracking: IEC 112: CTI > 600, VDE 0303: KB > 600



GOGATEM EURO RK grau / grey 6 – 95mm²

Nennquerschnitt (mm ²) / nominal cross section	6	10	16-25	35-50	70	95	
Typ EURO	6/35	10/35	25/35	50/35	70/35	95/35	
Klemmenbreite / clamping width	7 mm	9 mm	12 mm	16 mm	26 mm	26 mm	
Flexible Leiter (mm ²) / flexible conductors	0,5-6	1,5-10	1,5-16	2,5-50	16-70	16-95	
Feste Leiter (mm ²) / solid conductors	0,5-10	1,5-16	1,5-25	2,5-50	16-70	16-95	
Leiter m. Aderendhülsen (mm ²) / cond. W. CES	0,5-6	1,5-10	1,5-16	2,5-35	16-70	-	
AWG	22-8	20-6	14-4	14-1/0	4-3/0	3/0	
Kaliber / caliber	A5	B6	B7	B9	B11	-	
Anz. anschließb. Leiter / numb. of connectable cond.	2x4	2x6	2x10	2x25	2x50	-	
Leiteraufnahmeraum (mm) / connecting capacity	5x4	6x5,5	7x7,4	11x10	15,5x16,5	-	
Leiter abisolieren (mm) / stripping conductor	12	12	14	17	26	26	
Schraubengewinde / screwing thread	M3,5	M 4	M 5	M 6	M 8	-	
max. Anzugsdrehmoment (Nm) / max. tight. torque	1,2	2	3	5	10	4,5	
Mittelgewinde / central thread	M3	M 3	M 4	M 4	x	x	
Normen / norms	SEV	800V/55A	800V/80A	800V/101A	800V/150A	800V/192A	i.V.
	VDE	1000V/41A	1000V/57A	1000V/101A	1000V/150A	800V/192A	i.V.
	RINA	800V/41A	800V/57A	800V/101A	800V/150A	800V/192A	i.V.
	UL	600V/50A	600V/65A	600V/85A	600V/130A	600V/185A	i.V.
	CSA	600V/50A	600V/80A	600V/105A	600V/130A	600V/185A	i.V.
Abmessungen (mm) / dimensions	7x50x44	9x50x44	12x56x49	16x62x61	26x74x75	26x74x75	
Verpackungseinheit / PU	50	50	25	25	10	10	
ArtNr	44-43401	44-43402	44-43403	44-43404	44-43405	44-43426	
€/Stk. /pc.	1,53	1,97	2,69	4,59	14,80	16,48	



GOGATEM EURO RK bunt / colored

Nennquerschnitt mm ² / nominal cross	6	10	16-25	35-50	70	95
blau / blue	44-43401BL	44-43402BL	44-43403BL	44-43404BL	44-43405BL	44-43426BL
schwarz / black	-	-	-	-	-	-
braun / brown	-	-	-	-	-	-
rot / red	-	-	-	44-43404RD	-	-
gelb / yellow	-	-	-	-	44-43405N	-
€/Stk. /pc.	1,62	2,06	2,87	4,74	16,12	16,74
grün-gelb / green-yellow	44-43401E	44-43402E	44-43403E	44-43404E	44-43405E	-
€/Stk. /pc.	1,58	2,05	3,03	5,26	16,63	-

**Weitere Farben auf Anfrage /
other colors on request**

ACHTUNG! / ATTENTION!

Keine Verbindung zur
Hutschiene!

Siehe ERDUNGSKLEMMEN! /

No connection to the DIN rail!

See grounding clamps!

Preise gültig ab 01.01.2024 exkl. MwSt., freibleibend, Auftragsrabatt auf Anfrage /

prices are valid from 01.01.2024 excl. VAT, subject to change, discounts upon request

sonst. Konditionen siehe www.gogatec.com/AGB.pdf, techn. Änderungen vorbehalten /

terms & conditions can be found on our website: www.gogatec.com/AGB.pdf; error, technical modifications and variations are reserved

Aufschnappbar auf DIN-Hutschiene TS35 / snappable on DIN rail TS35



UL1059
E203985



40017950

Isolierkörper / insulating part: Polyamid 6.6

Verbindungssteg / connecting web: Messing / brass

Zugbügelklemme und Schraube / box clamp and screw: Stahl verzinkt, gelb chromatisiert / galvanized steel, yellow chromated

Trennhebel / release lever: Kupferlegierung verzinkt / tinned copper alloy

Kriechstromfestigkeit / comparative tracking: IEC 112: CTI > 600, VDE 0303: KB > 600

GOGATEM EURO T - Nq2,5

Nennquerschnitt (mm ²) / nominal cross section	2,5
Typ EURO	2,5/35
Klemmenbreite (mm) / clamping width	5
Flexible Leiter (mm ²) / flexible conductors	0,5-3,5
Feste Leiter (mm ²) / solid conductors	0,5-4
Leiter m. Aderendhülsen (mm ²) / cond. W. CES	0,5-2,5
AWG	24-12
Kaliber / caliber	A3
Anz. anschließb. Leiter (mm ²) / numb. of connectable cond.	2x1,5/4x1
Leiterraum (mm) / connecting capacity	3,6x2,6
Leiter abisloieren (mm) / stripping conductor	10
Schraubengewinde / screwing thread	M2,6
max. Anzugsdrehmoment (Nm) / max. tight. torque	0,5
Normen / norms SEV (mm ²)	2,5
RINA (mm ²)	2,5
VDE (mm ²)	2,5
UL	AWG: 22-12
CSA	AWG: 22-12

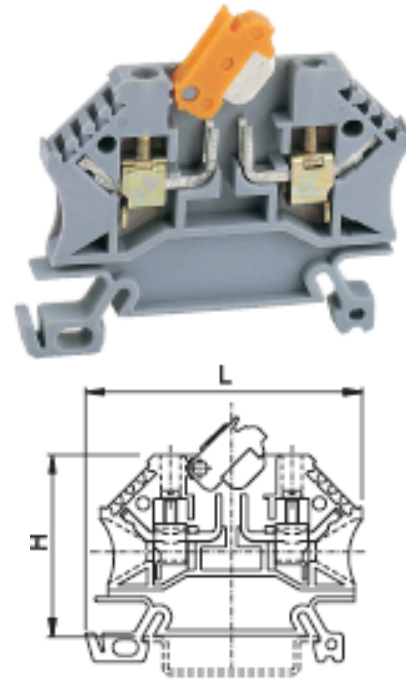

Typ	Abmessungen	VPE	ArtNr	€
type	mm	Stk.		/Stk.
	dimensions	PU		/pc.
Nq2,5 Trenn T1	5 x 52 x 35	100	44-43439	2,58

Preise gültig ab 01.01.2024 exkl. MwSt., freibleibend, Auftragsrabatt auf Anfrage /

prices are valid from 01.01.2024 excl. VAT, subject to change, discounts upon request

sonst. Konditionen siehe www.gogatec.com/AGB.pdf, techn. Änderungen vorbehalten /

terms & conditions can be found on our website: www.gogatec.com/AGB.pdf; error, technical modifications and variations are reserved

GOGATEM Endhalter Standard aufschraubbar / screwed standard end brackets

Material / material: Polyamid 6.6

Für Klemme <i>for clamp</i>	Abmessungen mm <i>dimensions</i>	VPE Stk. PU	ArtNr	€/Stk. /pc.
alle Klemmen / all clamps	58 x 36 x 9	50	44-43442	1,00

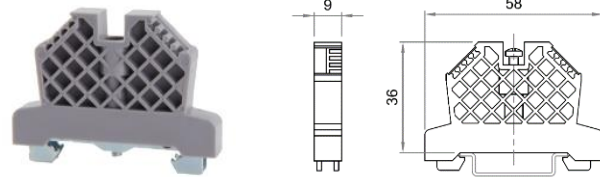

GOGATEM Endhalter schmal, aufschraubbar / end brackets small screwed

Für Klemme <i>for clamp</i>	Abmessungen mm <i>dimensions</i>	VPE Stk. PU	ArtNr	€/Stk. /pc.
alle Klemmen / all clamps	59 x 36 x 6	50	44-43444	0,81



GOGATEM Endhalter schmal, aufschnappbar / snappable small end brackets

Für Klemme <i>for clamp</i>	Abmessungen mm <i>dimensions</i>	VPE Stk. PU	ArtNr	€/Stk. /pc.
alle Klemmen / all clamps	60 x 36 x 6	50	44-43447	0,65



GOGATEM Endwinkel mit Beschriftungsplatte / end angle with inscription plate

Material / material: Polyamid 6.6

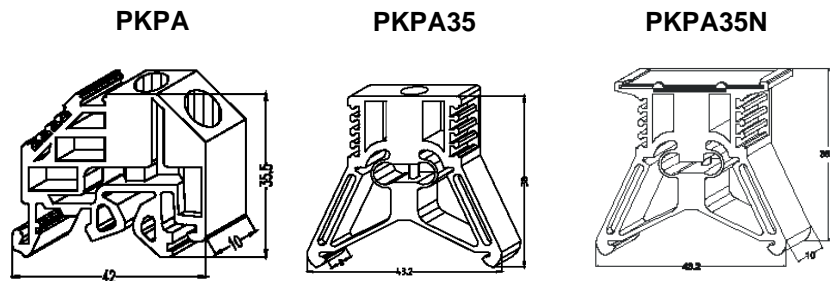

Typ <i>type</i>	Bemerkung <i>comment</i>	VPE Stk. PU	ArtNr	€/Stk. /pc.
PKPA 2,5-70	für Hut&C-Schiene / for DIN & C rail	1	61-PKPA	0,94
PKPA35	für Hutschiene / for DIN rail	1	61-PKPA35	0,63
PKPA35N	für Hutschiene / for DIN rail	1	61-PKPA35N	1,04

Preise gültig ab 01.01.2024 exkl. MwSt., freibleibend, Auftragsrabatt auf Anfrage /
prices are valid from 01.01.2024 excl. VAT, subject to change, discounts upon request
sonst. Konditionen siehe www.gogatec.com/AGB.pdf, techn. Änderungen vorbehalten /
terms & conditions can be found on our website: www.gogatec.com/AGB.pdf; error, technical modifications and variations are reserved

GOGATEM Abschlusswand / end wall

Material / material: Polyamid 6.6

Für Klemme <i>for clamp</i>	Abmessungen mm <i>dimensions</i>	VPE Stk. <i>PU</i>	ArtNr	€/Stk. <i>/pc.</i>
Euro 2,5/35	44 x 35 x 1,5	100	44-43010	0,35
Euro 4/35	44 x 35 x 1,5	100	44-43010	0,35
Euro 6/35	50 x 43 x 1,5	100	44-43011	0,40
Euro 10/35	50 x 43 x 1,5	100	44-43011	0,40
Euro 16-25/35	56 x 48 x 1,5	50	44-43013	0,47
Euro 35-50/35	62 x 60 x 1,5	50	44-43014	0,56

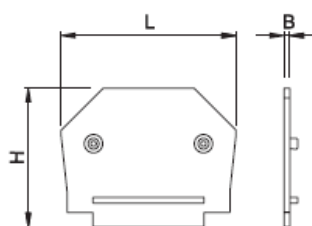

GOGATEM Trennwand / partition wall

Material / material: Polyamid 6.6

Für Klemme <i>for clamps</i>	Abmessungen mm <i>dimensions</i>	VPE Stk. <i>PU</i>	ArtNr	€/Stk. <i>/pc.</i>
Euro 2,5/35	55 x 44 x 1,5	100	44-43015	0,42
Euro 4/35	44 x 35 x 1,5	100	44-43015	0,42
Euro 6/35	55 x 49 x 1,5	100	44-43016	0,49
Euro 10/35	55 x 49 x 1,5	100	44-43016	0,49

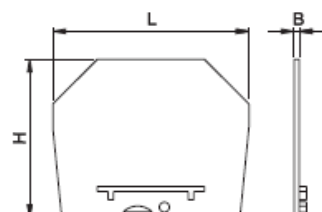

GOGATEM Klemmabdeckung / clamp cover

Material / material: Polycarbonat

Für Klemme <i>for clamp</i>	Abmessungen mm <i>dimensions</i>	VPE Stk. <i>PU</i>	ArtNr	€/Stk. <i>/pc.</i>
Euro 2,5/35	47 x 24,5 x 4,8	100	44-43035	0,50
Euro 4/35	47 x 24,5 x 5,8	100	44-43030	0,48
Euro 6/35	53 x 26 x 6,8	100	44-43031	0,50
Euro 16-25/35	59 x 26 x 11,5	50	44-43033	0,55
Euro 35-50/35	59 x 26 x 15,5	50	44-43034	0,66

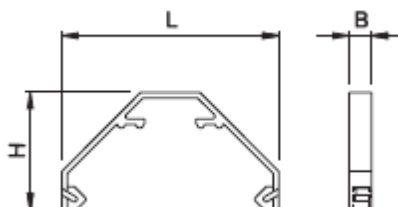

Preise gültig ab 01.01.2024 exkl. MwSt., freibleibend, Auftragsrabatt auf Anfrage /
prices are valid from 01.01.2024 excl. VAT, subject to change, discounts upon request
sonst. Konditionen siehe www.gogatec.com/AGB.pdf, techn. Änderungen vorbehalten /
terms & conditions can be found on our website: www.gogatec.com/AGB.pdf; error, technical modifications and variations are reserved

GOGATEM QVRJ2,5 Querverbindungsrechen für EURO RK 2,5 , Q 2,5 , X 2,5 / cross con. rakes

Für Klemmenbreite / for clamp width : 5mm

Typ	Pole	VPE	ArtNr	€
type	poles	Stk. /PU		/Stk. /pc.
QVRJ2,5-2	2	100	44-43525/02	51,90
QVRJ2,5-3	3	100	44-43525/03	72,90
QVRJ2,5-24	24	5	44-43525/24	30,11



GOGATEM QVRJ4 Querverbindungsrechen f. EURO RK 4,RK 5, 4/15, D4, Q4 / cross con. rakes

Für Klemmenbreite / for clamp width : 6mm

Typ	Pole	VPE	ArtNr	€
type	poles	Stk. /PU		/Stk. /pc.
QVRJ4-2	2	100	44-43520/02	51,90
QVRJ4-3	3	100	44-43520/03	76,50
QVRJ4-24	24	5	44-43520/24	30,12



GOGATEM QVRJ6 Querverbindungsrechen für Klemmen EURO 6 / cross connection rakes

Für Klemmenbreite / for clamp width : 7mm

Typ	Pole	VPE	ArtNr	€
type	poles	Stk. /PU		/Stk. /pc.
QVRJ6-2	2	50	44-43621/02	44,14
QVRJ6-3	3	50	44-43621/03	74,10
QVRJ6-24	24	5	44-43621/24	38,12



GOGATEM QVRJ6 Querverbindungsrechen für EURO Q6 / cross con. Rakes

Für Klemmenbreite / for clamp width : 8mm

Typ	Pole	VPE	ArtNr	€
type	poles	Stk. /PU		/Stk. /pc.
QVRJ6-2	2	100	44-43530/02	61,00
QVRJ6-3	3	100	44-43530/03	83,90
QVRJ6-12	12	10	44-43530/12	40,80



GOGATEM QVRJW-RDS2,5 Querverbindungsrechen für EURO W, WE, Z / cross con. rakes

Für Klemmenbreite / for clamp width : 5mm

Typ	Pole	VPE	ArtNr	€
type	poles	Stk. /PU		/VPE /PU
QVRJW2,5-2	2	100	44-43531/02RDS	64,20
QVRJW2,5-3	3	100	44-43531/03RDS	80,10
QVRJW2,5-12	12	10	44-43531/12RDS	23,67



GOGATEM QVRJW-BLS2,5 Querverbindungsrechen für EURO W, WE, Z / cross con. rakes

Für Klemmenbreite / for clamp width : 5mm

Typ	Pole	VPE	ArtNr	€
type	poles	Stk. /PU		/VPE /PU
QVRJW2,5-2	2	100	44-43531/02BLS	58,30
QVRJW2,5-3	3	100	44-43531/03BLS	80,10
QVRJW2,5-12	12	10	44-43531/12BLS	26,04



Preise gültig ab 01.01.2024 exkl. MwSt., freibleibend, Auftragsrabatt auf Anfrage /
prices are valid from 01.01.2024 excl. VAT, subject to change, discounts upon request
sonst. Konditionen siehe www.gogatec.com/AGB.pdf, techn. Änderungen vorbehalten /
terms & conditions can be found on our website: www.gogatec.com/AGB.pdf; error, technical modifications and variations are reserved

GOGATEM SLS-QVRJ Schneidwerkzeug f. Querverbindungsrechen / cutting tool

Typ <i>type</i>	Farbe <i>color</i>	f. Verbindungsrechen Rechen <i>for cross con. Rakes</i>	VPE Stk. <i>PU</i>	ArtNr	€/Stk. <i>/pc.</i>
SW-QVRJ2,5	orange / orange	QVRJ2,5	1	44-43515	75,30
SW-QVRJ4	gelb / yellow	QVRJ4	1	44-43516	75,30
SW-QVRJ6	grün / green	QVRJ6	1	44-43518	90,40



Preise gültig ab 01.01.2024 exkl. MwSt., freibleibend, Auftragsrabatt auf Anfrage /
prices are valid from 01.01.2024 excl. VAT, subject to change, discounts upon request
sonst. Konditionen siehe www.gogatec.com/AGB.pdf, techn. Änderungen vorbehalten /
terms & conditions can be found on our website: www.gogatec.com/AGB.pdf; error, technical modifications and variations are reserved

GOGATEM Querverbindungsrechen mit Schrauben / cross connection rakes with screws

Für Klemme <i>for clamp</i>	Schrauben <i>screws</i>	ArtNr	€ /Stk. /pc.
Euro 10/35 Art. Nr. 44-43402	55	44-43022/0.5MS	21,13
Euro 16-25/35 Art. Nr. 44-43403	41	44-43023/0.5MS	30,10
Euro 35-50/35 Art. Nr. 44-43404	32	44-43024/0.5MS	38,29
Euro 4/15 Art. Nr. 44-43420	82	44-43082/0.5MS	31,03

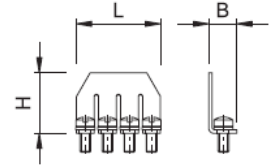

GOGATEM 1 Stück 2-polig + 2 Schrauben / 1 x 2-pole + 2 screws

Für Klemme <i>for clamp</i>	VPE Stk. <i>PU</i>	ArtNr	€ /VPE /PU
Euro 10/35 Art. Nr. 44-43402	100	44-43022/2S	63,40
Euro 16-25/35 Art. Nr. 44-43403	50	44-43023/2S	65,10
Euro 35-50/35 Art. Nr. 44-43404	50	44-43024/2S	194,00
Euro 4/15 Art. Nr. 44-43420	100	44-43082/2S	76,20



GOGATEM 1 Stück 3-polig + 3 Schrauben / 1 x 3-pole + 3 screws

Für Klemme <i>for clamp</i>	VPE Stk. <i>PU</i>	ArtNr	€ /VPE /PU
Euro 10/35 Art. Nr. 44-43402	100	44-43022/3S	94,40
Euro 16-25/35 Art. Nr. 44-43403	100	44-43023/3S	169,00
Euro 35-50/35 Art. Nr. 44-43404	50	44-43024/3S	3,01
Euro 4/15 Art. Nr. 44-43420	100	44-43082/3S	112,70



GOGATEM 1 Stück 4-polig + 4 Schrauben / 1 x 4-pole + 4 screws

Für Klemme <i>for clamp</i>	VPE Stk. <i>PU</i>	ArtNr	€ /VPE /PU
Euro 10/35 Art. Nr. 44-43402	100	44-43022/4S	122,50
Euro 16-25/35 Art. Nr. 44-43403	100	44-43023/4S	225,00
Euro 35-50/35 Art. Nr. 44-43404	25	44-43024/4S	116,30
Euro 4/15 Art. Nr. 44-43420	100	44-43082/4S	148,20

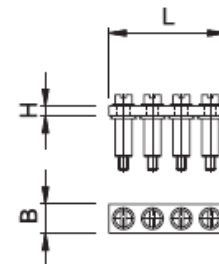

Preise gültig ab 01.01.2024 exkl. MwSt., freibleibend, Auftragsrabatt auf Anfrage /
prices are valid from 01.01.2024 excl. VAT, subject to change, discounts upon request
sonst. Konditionen siehe www.gogatec.com/AGB.pdf, techn. Änderungen vorbehalten /
terms & conditions can be found on our website: www.gogatec.com/AGB.pdf; error, technical modifications and variations are reserved

GOGATEM Prüfadapter rot / red test adapter

Material / material: Messing versilbert / silver plated brass

Für Klemme <i>for clamp</i>	Durchmesser mm <i>diameter</i>	VPE Stk. PU	ArtNr	€/Stk. /pc.
Euro 4/35 Art. Nr. 44-43400	2,8	10	44-43926R	5,41
Euro 6/35 Art. Nr. 44-43401	2,8	10	44-43926R	5,41
Euro 10/35 Art. Nr. 44-43402	2,8	10	44-43926R	5,41

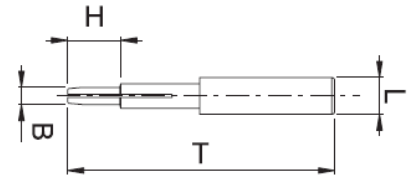

GOGATEM Prüfadapter schwarz / red test adapter

Material / material: Messing versilbert / silver plated brass

Für Klemme <i>for clamp</i>	Durchmesser mm <i>diameter</i>	VPE Stk. PU	ArtNr	€/Stk. /pc.
Euro 4/35 Art. Nr. 44-43400	2,8	10	44-43926S	5,41
Euro 6/35 Art. Nr. 44-43401	2,8	10	44-43926S	5,41
Euro 10/35 Art. Nr. 44-43402	2,8	10	44-43926S	5,41

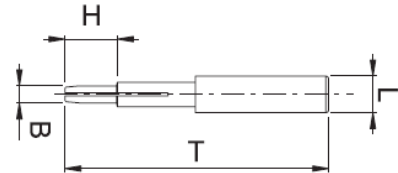

Preise gültig ab 01.01.2024 exkl. MwSt., freibleibend, Auftragsrabatt auf Anfrage /
prices are valid from 01.01.2024 excl. VAT, subject to change, discounts upon request
sonst. Konditionen siehe www.gogatec.com/AGB.pdf, techn. Änderungen vorbehalten /
terms & conditions can be found on our website: www.gogatec.com/AGB.pdf; error, technical modifications and variations are reserved