

## Kleinkabelschuhe isoliert Nylon transparent / insulated mini cable lugs nylon transparent

### GOGAPIN KKS3-RK Quetschkabelschuh-Ring isoliert, easy entry / insulated solderless cable lug ring, easy entry

Nylon

**Material / material:** E-Cu, gal. Sn, gelötet  
**Material Isolation / insulation:** Nylon transparent / nylon transparent  
**Temperaturbereich / temperature range:** -60°C - +105°C  
**Zulassung / approval:** UL listed  
**Normen / standards:** DIN 46237, DIN 46234  
**Rohr/Hals gelötet / tube brazed**

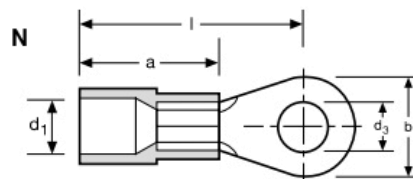

Passende Werkzeuge siehe GOGATOOL Katalog / for appropriate tools please see GOGATOOL catalog

| FC | Typ<br>type      | Bereich<br>mm <sup>2</sup><br>range | Loch<br>für<br>hole size | Abmessungen mm<br>dimensions mm |      |      |      |      | VPE<br>Stk.<br>PU | ArtNr        | €<br>/100 Stk.<br>/100 pcs. |              |
|----|------------------|-------------------------------------|--------------------------|---------------------------------|------|------|------|------|-------------------|--------------|-----------------------------|--------------|
|    |                  |                                     |                          | d3                              | b    | d1   | l    | a    |                   |              |                             |              |
| RT | KKS3-RK-1,5-M2,5 | 0,5 - 1,5                           | M2,5                     | 2,7                             | 6,0  | 4,0  | 16,0 | 10,0 | 0,8               | 100          | 1212100015025               | 9,68         |
|    | KKS3-RK-1,5-M3   |                                     | M3                       | 3,2                             | 6,0  | 4,0  | 16,0 | 10,0 | 0,8               | 100          | 121210001503                | 9,76         |
|    | KKS3-RK-1,5-M3,5 |                                     | M3,5                     | 3,7                             | 6,0  | 4,0  | 16,0 | 10,0 | 0,8               | 100          | 1212100015035               | 9,76         |
|    | KKS3-RK-1,5-M4   |                                     | M4                       | 4,3                             | 8,0  | 4,0  | 17,0 | 10,0 | 0,8               | 100          | 121210001504                | 10,28        |
|    | KKS3-RK-1,5-M5   |                                     | M5                       | 5,3                             | 10,0 | 4,0  | 18,0 | 10,0 | 0,8               | 100          | 121210001505                | 11,12        |
|    | KKS3-RK-1,5-M6   |                                     | M6                       | 6,5                             | 11,0 | 4,0  | 21,0 | 10,0 | 0,8               | 100          | 121210001506                | 9,87         |
|    | KKS3-RK-1,5-M8   |                                     | M8                       | 8,4                             | 11,6 | 4,0  | 22,0 | 10,0 | 0,8               | 100          | 121210001508                | 13,78        |
|    | KKS3-RK-1,5-M10  | M10                                 | 10,5                     | 13,7                            | 4,0  | 24,0 | 10,0 | 0,8  | 100               | 121210001510 | 18,69                       |              |
| BL | KKS3-RK-2,5-M3   | 1,5 - 2,5                           | M3                       | 3,2                             | 6,0  | 4,5  | 17,0 | 11,0 | 0,8               | 100          | 121210002503                | 10,59        |
|    | KKS3-RK-2,5-M3,5 |                                     | M3,5                     | 3,7                             | 6,0  | 4,5  | 17,0 | 11,0 | 0,8               | 100          | 1212100025035               | 9,58         |
|    | KKS3-RK-2,5-M4   |                                     | M4                       | 4,3                             | 8,0  | 4,5  | 18,0 | 11,0 | 0,8               | 100          | 121210002504                | 11,27        |
|    | KKS3-RK-2,5-M5   |                                     | M5                       | 5,3                             | 10,0 | 4,5  | 20,0 | 11,0 | 0,8               | 100          | 121210002505                | 12,04        |
|    | KKS3-RK-2,5-M6   |                                     | M6                       | 6,5                             | 11,0 | 4,5  | 22,0 | 11,0 | 0,8               | 100          | 121210002506                | 9,27         |
|    | KKS3-RK-2,5-M8   |                                     | M8                       | 8,4                             | 12,0 | 4,5  | 22,0 | 11,0 | 0,8               | 100          | 121210002508                | 14,87        |
|    | KKS3-RK-2,5-M10  |                                     | M10                      | 10,5                            | 13,7 | 4,5  | 25,0 | 11,0 | 0,8               | 100          | 121210002510                | 19,52        |
|    | KKS3-RK-2,5-M12  | M12                                 | 13,0                     | 18,0                            | 4,5  | 25,0 | 11,0 | 0,8  | 100               | 121210002512 | 28,37                       |              |
| GE | KKS3-RK-6,0-M4   | 4,0 - 6,0                           | M4                       | 4,3                             | 8,0  | 6,6  | 20,0 | 14,0 | 1,0               | 100          | 121210006004                | 16,84        |
|    | KKS3-RK-6,0-M5   |                                     | M5                       | 5,3                             | 10,0 | 6,6  | 21,0 | 14,0 | 1,0               | 100          | 121210006005                | 16,84        |
|    | KKS3-RK-6,0-M6   |                                     | M6                       | 6,5                             | 11,0 | 6,6  | 22,0 | 14,0 | 1,0               | 100          | 121210006006                | 22,18        |
|    | KKS3-RK-6,0-M8   |                                     | M8                       | 8,4                             | 14,0 | 6,6  | 25,0 | 14,0 | 1,0               | 100          | 121210006008                | 22,18        |
|    | KKS3-RK-6,0-M10  |                                     | M10                      | 10,5                            | 18,0 | 6,6  | 27,0 | 14,0 | 1,0               | 100          | 121210006010                | 23,93        |
|    | KKS3-RK-6,0-M12  |                                     | M12                      | 13,0                            | 19,0 | 6,6  | 32,0 | 14,0 | 1,0               | 100          | 121210006012                | 26,36        |
|    |                  |                                     | KKS3-RK-6,0-M14          | M14                             | 15,0 | 19,2 | 6,6  | 30,4 | 14,0              | 1,0          | 100                         | 121210006014 |

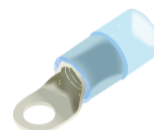

### GOGAPIN KKS3-SV Stoßverbinder isoliert, easy entry / insulated butt, easy entry

**Material / material:** E-Cu, gal. Sn  
**Material Isolation / insulation:** Nylon transparent / nylon transparent  
**Temperaturbereich / temperature range:** -60°C - +105°C  
**Zulassung / approval:** UL listed

Nylon

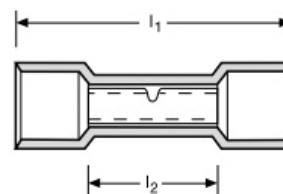

Passende Werkzeuge siehe GOGATOOL Katalog / for appropriate tools please see GOGATOOL catalog

| FC | Typ<br>type | Bereich<br>mm <sup>2</sup><br>range | Abmessungen mm<br>dimensions mm |      |     | VPE<br>Stk.<br>PU | ArtNr      | €<br>/100 Stk.<br>/100 pcs. |
|----|-------------|-------------------------------------|---------------------------------|------|-----|-------------------|------------|-----------------------------|
|    |             |                                     | l1                              | l2   | s   |                   |            |                             |
| GE | KKS3-SV-0,5 | 0,1 - 0,5                           | 20,0                            | 12,0 | 0,4 | 100               | 1212800005 | 15,52                       |
| RT | KKS3-SV-1,5 | 0,5 - 1,5                           | 25,0                            | 15,0 | 0,8 | 100               | 1212800015 | 9,39                        |
| BL | KKS3-SV-2,5 | 1,5 - 2,5                           | 25,0                            | 15,0 | 0,8 | 100               | 1212800025 | 10,20                       |
| GE | KKS3-SV-6,0 | 4,0 - 6,0                           | 27,0                            | 15,0 | 1,0 | 100               | 1212800060 | 16,80                       |



Preise gültig ab 01.01.2024 exkl. MwSt., freibleibend, Auftragsrabatt auf Anfrage /  
prices are valid from 01.01.2024 excl. VAT, subject to change, discounts upon request  
sonst. Konditionen siehe [www.gogatec.com/AGB.pdf](http://www.gogatec.com/AGB.pdf), techn. Änderungen vorbehalten /  
terms & conditions can be found on our website: [www.gogatec.com/AGB.pdf](http://www.gogatec.com/AGB.pdf); error, technical modifications and variations are reserved

## Kleinkabelschuhe isoliert Nylon transparent / insulated mini cable lugs nylon transparent

### GOGAPIN KKS3-GK Quetschkabelschuh-Gabel isoliert, easy entry / insulated solderless cable lug fork, easy entry

Nylon

**Material / material:** E-Cu, gal. Sn, gelötet  
**Material Isolation / insulation:** Nylon transparent / nylon transparent  
**Temperaturbereich / temperature range:** -60°C - +105°C  
**Zulassung / approval:** UL listed  
**Normen / standards:** DIN 46237 und ähnlich / and similar

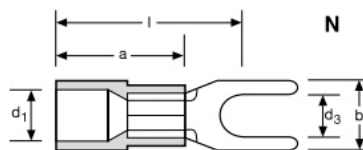

Passende Werkzeuge siehe GOGATOOL Katalog / for appropriate tools please see GOGATOOL catalog

| FC | Typ<br>type      | Bereich<br>mm <sup>2</sup><br>range | Loch<br>für<br>hole size | Abmessungen mm<br>dimensions mm |      |     |      |      |     | VPE<br>Stk.<br>PU | ArtNr         | €<br>/100 Stk.<br>/100 pcs. |
|----|------------------|-------------------------------------|--------------------------|---------------------------------|------|-----|------|------|-----|-------------------|---------------|-----------------------------|
| RT | KKS3-GK-1,5-M3   | 0,5 - 1,5                           | M3                       | 3,2                             | 5,7  | 4,1 | 17,7 | 10,0 | 0,8 | 100               | 121220001503  | 9,76                        |
|    | KKS3-GK-1,5-M3,5 |                                     | M3,5                     | 3,7                             | 6,0  | 4,1 | 17,7 | 10,0 | 0,8 | 100               | 1212200015035 | 9,76                        |
|    | KKS3-GK-1,5-M4   |                                     | M4                       | 4,3                             | 7,2  | 4,1 | 17,0 | 10,0 | 0,8 | 100               | 121220001504  | 9,76                        |
|    | KKS3-GK-1,5-M5   |                                     | M5                       | 5,3                             | 8,0  | 4,1 | 17,0 | 10,0 | 0,8 | 100               | 121220001505  | 10,50                       |
|    | KKS3-GK-1,5-M6   |                                     | M6                       | 6,4                             | 10,7 | 4,1 | 18,5 | 10,0 | 0,8 | 100               | 121220001506  | 13,70                       |
|    | KKS3-GK-1,5-M8   |                                     | M8                       | 8,4                             | 13,5 | 4,1 | 21,5 | 10,0 | 0,8 | 100               | 121220001508  | 29,61                       |
| BL | KKS3-GK-2,5-M3   | 1,5 - 2,5                           | M3                       | 3,2                             | 5,7  | 4,5 | 17,5 | 11,0 | 0,8 | 100               | 121220002503  | 10,78                       |
|    | KKS3-GK-2,5-M3,5 |                                     | M3,5                     | 3,7                             | 6,2  | 4,5 | 17,5 | 11,0 | 0,8 | 100               | 1212200025035 | 10,78                       |
|    | KKS3-GK-2,5-M4   |                                     | M4                       | 4,3                             | 7,2  | 4,5 | 17,5 | 11,0 | 0,8 | 100               | 121220002504  | 11,12                       |
|    | KKS3-GK-2,5-M5   |                                     | M5                       | 5,3                             | 8,0  | 4,5 | 17,5 | 11,0 | 0,8 | 100               | 121220002505  | 11,27                       |
|    | KKS3-GK-2,5-M6   |                                     | M6                       | 6,4                             | 10,7 | 4,5 | 18,6 | 11,0 | 0,8 | 100               | 121220002506  | 9,98                        |
|    | KKS3-GK-2,5-M10  |                                     | M10                      | 10,5                            | 15,0 | 4,5 | 23,0 | 10,0 | 0,8 | 100               | 121220002510  | 26,62                       |
| GE | KKS3-GK-6,0-M3,5 | 4,0 - 6,0                           | M3,5                     | 3,7                             | 8,1  | 6,6 | 21,1 | 14,0 | 1,0 | 100               | 1212200060035 | 17,45                       |
|    | KKS3-GK-6,0-M4   |                                     | M4                       | 4,3                             | 8,2  | 6,6 | 21,5 | 14,0 | 1,0 | 100               | 121220006004  | 17,45                       |
|    | KKS3-GK-6,0-M5   |                                     | M5                       | 5,3                             | 9,0  | 6,6 | 22,0 | 14,0 | 1,0 | 100               | 121220006005  | 18,78                       |
|    | KKS3-GK-6,0-M6   |                                     | M6                       | 6,4                             | 12,0 | 6,6 | 23,5 | 14,0 | 1,0 | 100               | 121220006006  | 22,18                       |
|    | KKS3-GK-6,0-M8   |                                     | M8                       | 8,4                             | 13,5 | 6,6 | 25,0 | 14,0 | 1,0 | 100               | 121220006008  | 26,62                       |
|    | KKS3-GK-6,0-M10  |                                     | M10                      | 10,5                            | 18,0 | 6,4 | 27,0 | 12,0 | 1,0 | 100               | 121220006010  | 38,93                       |



### GOGAPIN KKS3-SK Stiftkabelschuh isoliert, easy entry / insulated pin cable lug, easy entry

Nylon

**Material / material:** E-Cu, gal. Sn, gelötet  
**Material Isolation / insulation:** Nylon transparent / nylon transparent  
**Temperaturbereich / temperature range:** -60°C - +105°C  
**Zulassung / approval:** UL listed  
**Normen / standards:** DIN 46231 und ähnlich / and similar

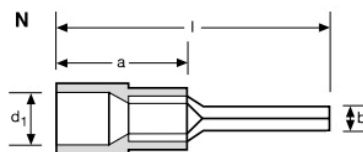

Passende Werkzeuge siehe GOGATOOL Katalog / for appropriate tools please see GOGATOOL catalog

| FC | Typ<br>type      | Bereich<br>mm <sup>2</sup><br>range | Stift<br>mm<br>pin | Abmessungen mm<br>dimensions mm |     |      |      |     |     | VPE<br>Stk.<br>PU | ArtNr | €<br>/100 Stk.<br>/100 pcs. |
|----|------------------|-------------------------------------|--------------------|---------------------------------|-----|------|------|-----|-----|-------------------|-------|-----------------------------|
| RT | KKS3-SK-1,5-1909 | 0,5 - 1,5                           | 9,0                | 1,9                             | 4,1 | 19,0 | 10,0 | 0,8 | 100 | 12123000151909    | 12,10 |                             |
|    | KKS3-SK-1,5-1912 |                                     | 12,0               | 1,9                             | 4,1 | 22,0 | 10,0 | 0,8 | 100 | 12123000151912    | 12,10 |                             |
| BL | KKS3-SK-2,5-1909 | 1,5 - 2,5                           | 9,0                | 1,9                             | 4,5 | 20,0 | 11,0 | 0,8 | 100 | 12123000251909    | 12,78 |                             |
|    | KKS3-SK-2,5-1911 |                                     | 11,0               | 1,9                             | 4,5 | 23,5 | 11,0 | 0,8 | 100 | 12123000251911    | 12,78 |                             |
| GE | KKS3-SK-6,0-2714 | 4,0 - 6,0                           | 14,0               | 2,7                             | 6,6 | 27,0 | 13,0 | 1,0 | 100 | 12123000602714    | 17,60 |                             |



Preise gültig ab 01.01.2024 exkl. MwSt., freibleibend, Auftragsrabatt auf Anfrage /  
prices are valid from 01.01.2024 excl. VAT, subject to change, discounts upon request  
sonst. Konditionen siehe [www.gogatec.com/AGB.pdf](http://www.gogatec.com/AGB.pdf), techn. Änderungen vorbehalten /  
terms & conditions can be found on our website: [www.gogatec.com/AGB.pdf](http://www.gogatec.com/AGB.pdf); error, technical modifications and variations are reserved

## Kleinkabelschuhe isoliert Nylon transparent / insulated mini cable lugs nylon transparent

### GOGAPIN KKS3-FH Flachsteckhülse isoliert, easy entry / insulated female disconnect, easy entry

**Material:** Messing, gal. verzinkt / brass tin-plated  
**Material Isolation / insulation:** Nylon transparent / nylon transparent  
**Temperaturbereich / temperature range:** -60°C - +105°C  
**Zulassung / approval:** UL listed  
**Normen / standards:** DIN 46245 und ähnlich / and similar

Nylon

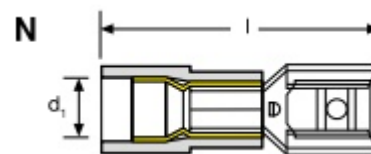

Passende Werkzeuge siehe GOGATOOL Katalog / for appropriate tools please see GOGATOOL catalog

| FC | Typ<br>type      | Bereich<br>mm <sup>2</sup><br>range | Steckgröße<br>mm<br>tab size | Abmessung mm<br>dimensions mm |     |      | VPE<br>Stk.<br>PU | ArtNr          | €<br>/100 Stk.<br>/100 pcs. |
|----|------------------|-------------------------------------|------------------------------|-------------------------------|-----|------|-------------------|----------------|-----------------------------|
|    |                  |                                     |                              | l                             | d1  | s    |                   |                |                             |
| RT | KKS3-FH-1,5-2805 | 0,5 - 1,5                           | 2,8 - 0,5                    | 19,0                          | 4,1 | 0,25 | 100               | 12125000152805 | 10,50                       |
|    | KKS3-FH-1,5-2808 |                                     | 2,8 - 0,8                    | 19,0                          | 4,1 | 0,25 | 100               | 12125000152808 | 10,50                       |
|    | KKS3-FH-1,5-4805 |                                     | 4,8 - 0,5                    | 19,5                          | 4,1 | 0,40 | 100               | 12125000154805 | 12,10                       |
|    | KKS3-FH-1,5-4808 |                                     | 4,8 - 0,8                    | 19,5                          | 4,1 | 0,40 | 100               | 12125000154808 | 12,10                       |
|    | KKS3-FH-1,5-6308 |                                     | 6,3 - 0,8                    | 21,5                          | 4,1 | 0,40 | 100               | 12125000156308 | 11,53                       |
|    | KKS3-FH-1,5-8008 |                                     | 8,0 - 0,8                    | 24,5                          | 4,1 | 0,40 | 100               | 12125000158008 | 20,44                       |
| BL | KKS3-FH-2,5-2805 | 1,5 - 2,5                           | 2,8 - 0,5                    | 19,5                          | 5,0 | 0,25 | 100               | 12125000252805 | 11,53                       |
|    | KKS3-FH-2,5-2808 |                                     | 2,8 - 0,8                    | 19,5                          | 5,0 | 0,25 | 100               | 12125000252808 | 9,98                        |
|    | KKS3-FH-2,5-4805 |                                     | 4,8 - 0,5                    | 20,0                          | 5,0 | 0,40 | 100               | 12125000254805 | 13,28                       |
|    | KKS3-FH-2,5-4808 |                                     | 4,8 - 0,8                    | 20,0                          | 5,0 | 0,40 | 100               | 12125000254808 | 13,28                       |
|    | KKS3-FH-2,5-6308 |                                     | 6,3 - 0,8                    | 21,5                          | 5,0 | 0,40 | 100               | 12125000256308 | 12,06                       |
|    | KKS3-FH-2,5-8008 |                                     | 8,0 - 0,8                    | 24,5                          | 5,0 | 0,40 | 100               | 12125000258008 | 20,37                       |
| GE | KKS3-FH-6,0-2805 | 4,0 - 6,0                           | 2,8 - 0,5                    | 22,5                          | 6,6 | 0,40 | 100               | 12125000602805 | 17,45                       |
|    | KKS3-FH-6,0-2808 |                                     | 2,8 - 0,8                    | 22,5                          | 6,6 | 0,40 | 100               | 12125000602808 | 17,45                       |
|    | KKS3-FH-6,0-4805 |                                     | 4,8 - 0,5                    | 23,0                          | 6,6 | 0,40 | 100               | 12125000604805 | 17,45                       |
|    | KKS3-FH-6,0-4808 |                                     | 4,8 - 0,8                    | 23,0                          | 6,6 | 0,40 | 100               | 12125000604808 | 17,45                       |
|    | KKS3-FH-6,0-6308 |                                     | 6,3 - 0,8                    | 24,0                          | 6,6 | 0,40 | 100               | 12125000606308 | 19,87                       |
|    | KKS3-FH-6,0-9512 |                                     | 9,5 - 1,2                    | 28,6                          | 6,6 | 0,40 | 100               | 12125000609512 | 23,34                       |



### GOGAPIN KKS3-FHVI Flachsteckhülse vollisoliert, easy entry / fully insulated female disconnect, easy entry

**Material:** Messing, gal. verzinkt / brass tin-plated  
**Material Isolation / insulation:** Nylon transparent / nylon transparent  
**Temperaturbereich / temperature range:** -60°C - +105°C  
**Zulassung / approval:** UL listed

Nylon

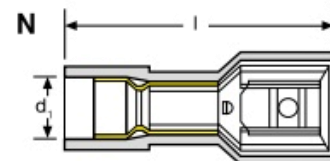

Passende Werkzeuge siehe GOGATOOL Katalog / for appropriate tools please see GOGATOOL catalog

| FC | Typ<br>type        | Bereich<br>mm <sup>2</sup><br>range | Steckgröße<br>mm<br>tab size | Abmessung mm<br>dimensions mm |     |      | VPE<br>Stk.<br>PU | ArtNr          | €<br>/100 Stk.<br>/100 pcs. |
|----|--------------------|-------------------------------------|------------------------------|-------------------------------|-----|------|-------------------|----------------|-----------------------------|
|    |                    |                                     |                              | l                             | d1  | s    |                   |                |                             |
| RT | KKS3-FHVI-1,5-2805 | 0,5 - 1,5                           | 2,8 - 0,5                    | 20,5                          | 4,1 | 0,25 | 100               | 12125100152805 | 11,92                       |
|    | KKS3-FHVI-1,5-2808 |                                     | 2,8 - 0,8                    | 20,5                          | 4,1 | 0,25 | 100               | 12125100152808 | 11,76                       |
|    | KKS3-FHVI-1,5-4805 |                                     | 4,8 - 0,5                    | 20,5                          | 4,1 | 0,40 | 100               | 12125100154805 | 11,76                       |
|    | KKS3-FHVI-1,5-4808 |                                     | 4,8 - 0,8                    | 20,5                          | 4,1 | 0,40 | 100               | 12125100154808 | 24,34                       |
|    | KKS3-FHVI-1,5-6308 |                                     | 6,3 - 0,8                    | 22,0                          | 4,1 | 0,40 | 100               | 12125100156308 | 12,64                       |
|    | KKS3-FHVI-2,5-4805 | 1,5 - 2,5                           | 4,8 - 0,5                    | 21,5                          | 4,9 | 0,40 | 100               | 12125100254805 | 21,35                       |
| BL | KKS3-FHVI-2,5-4808 |                                     | 4,8 - 0,8                    | 21,5                          | 4,9 | 0,40 | 100               | 12125100254808 | 12,10                       |
|    | KKS3-FHVI-2,5-6308 |                                     | 6,3 - 0,8                    | 22,5                          | 4,9 | 0,40 | 100               | 12125100256308 | 12,59                       |
| GE | KKS3-FHVI-6,0-6308 | 4,0 - 6,0                           | 6,3 - 0,8                    | 25,0                          | 6,7 | 0,40 | 100               | 12125100606308 | 18,52                       |



Preise gültig ab 01.01.2024 exkl. MwSt., freibleibend, Auftragsrabatt auf Anfrage /  
prices are valid from 01.01.2024 excl. VAT, subject to change, discounts upon request  
sonst. Konditionen siehe [www.gogatec.com/AGB.pdf](http://www.gogatec.com/AGB.pdf), techn. Änderungen vorbehalten /  
terms & conditions can be found on our website: [www.gogatec.com/AGB.pdf](http://www.gogatec.com/AGB.pdf); error, technical modifications and variations are reserved

**GOGAPIN KKS3-FS Flachstecker isoliert, easy entry / insulated male disconnects, easy entry**

**Material:** Messing, gal. verzinkt / brass tin-plated  
**Material Isolation / insulation:** Nylon transparent / nylon transparent  
**Temperaturbereich / temperature range:** -60°C - +105°C  
**Zulassung / approval:** UL listed  
**Rohr/Hals gelötet / tube brazed**

Nylon

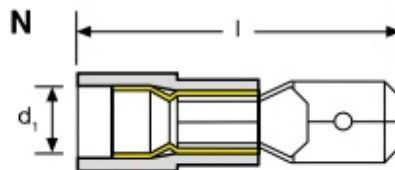

**Passende Werkzeuge siehe GOGATOOL Katalog / for appropriate tools please see GOGATOOL catalog**

| FC | Typ              | Bereich<br>mm <sup>2</sup><br>range | Steckgröße<br>mm<br>tab size | Abmessungen mm |     |      | VPE<br>Stk.<br>PU | ArtNr          | €<br>/100 Stk.<br>/100 pcs. |
|----|------------------|-------------------------------------|------------------------------|----------------|-----|------|-------------------|----------------|-----------------------------|
|    | type             |                                     |                              | l              | d1  | s    |                   |                |                             |
| RT | KKS3-FS-1,5-2805 | 0,5 - 1,5                           | 2,8 - 0,5                    | 22,0           | 4,1 | 0,25 | 100               | 12124000152805 | 22,18                       |
|    | KKS3-FS-1,5-2808 |                                     | 2,8 - 0,8                    | 22,0           | 4,1 | 0,40 | 100               | 12124000152808 | 22,18                       |
|    | KKS3-FS-1,5-4805 |                                     | 4,8 - 0,5                    | 22,0           | 4,1 | 0,25 | 100               | 12124000154805 | 22,18                       |
|    | KKS3-FS-1,5-4808 |                                     | 4,8 - 0,8                    | 22,0           | 4,1 | 0,40 | 100               | 12124000154808 | 22,18                       |
|    | KKS3-FS-1,5-6308 |                                     | 6,3 - 0,8                    | 22,0           | 4,1 | 0,40 | 100               | 12124000156308 | 11,53                       |
| BL | KKS3-FS-2,5-4805 | 1,5 - 2,5                           | 4,8 - 0,5                    | 22,5           | 5,0 | 0,25 | 100               | 12124000254805 | 22,18                       |
|    | KKS3-FS-2,5-4808 |                                     | 4,8 - 0,8                    | 22,5           | 5,0 | 0,40 | 100               | 12124000254808 | 22,18                       |
|    | KKS3-FS-2,5-6308 |                                     | 6,3 - 0,8                    | 22,5           | 5,0 | 0,40 | 100               | 12124000256308 | 12,67                       |
| GE | KKS3-FS-6,0-4805 | 4,0 - 6,0                           | 4,8 - 0,5                    | 24,5           | 6,6 | 0,25 | 100               | 12124000604805 | 22,18                       |
|    | KKS3-FS-6,0-4808 |                                     | 4,8 - 0,8                    | 24,5           | 6,6 | 0,40 | 100               | 12124000604808 | 22,18                       |
|    | KKS3-FS-6,0-6308 |                                     | 6,3 - 0,8                    | 24,5           | 6,6 | 0,40 | 100               | 12124000606308 | 18,77                       |



**GOGAPIN KKS3-FH90 Flachsteckhülse seil. Leiteranschluss isoliert, easy entry / insulated female disconnects flag-type, easy entry**

**Material:** Messing, gal. verzinkt / brass tin-plated  
**Material Isolation / insulation:** Nylon transparent / nylon transparent  
**Temperaturbereich / temperature range:** -60°C - +105°C  
**Zulassung / approval:** UL listed



Nylon

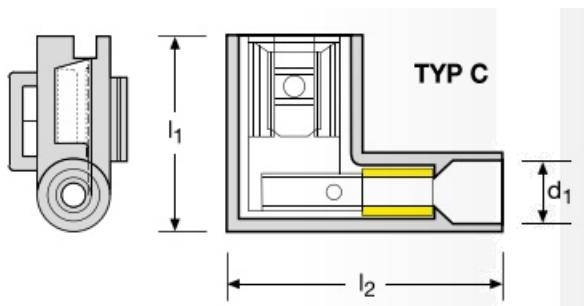

**Passende Werkzeuge siehe GOGATOOL Katalog / for appropriate tools please see GOGATOOL catalog**

| FC | Typ                | Bereich<br>mm <sup>2</sup><br>range | Steckgröße<br>mm<br>tab-width | Abmessungen mm |      |     | VPE<br>Stk.<br>PU | ArtNr          | €<br>/100 Stk.<br>/100 pcs. |
|----|--------------------|-------------------------------------|-------------------------------|----------------|------|-----|-------------------|----------------|-----------------------------|
|    | type               |                                     |                               | l1             | l2   | s   |                   |                |                             |
| RT | KKS3-FH90-1,5-4808 | 0,5 - 1,5                           | 4,8 - 0,8                     | 14,5           | 19,0 | 3,6 | 100               | 12125800154808 | 24,49                       |
|    | KKS3-FH90-1,5-6308 |                                     | 6,3 - 0,8                     | 16,5           | 20,6 | 3,9 | 100               | 12125800156308 | 30,82                       |
| BL | KKS3-FH90-2,5-6308 | 1,5 - 2,5                           | 6,3 - 0,8                     | 16,6           | 20,8 | 4,4 | 100               | 12125800256308 | 37,61                       |
| GE | KKS3-FH90-6,0-6308 | 4,0 - 6,0                           | 6,3 - 0,8                     | 17,5           | 23,0 | 6,3 | 100               | 12125800606308 | 40,00                       |



Preise gültig ab 01.01.2024 exkl. MwSt., freibleibend, Auftragsrabatt auf Anfrage /  
prices are valid from 01.01.2024 excl. VAT, subject to change, discounts upon request  
sonst. Konditionen siehe [www.gogatec.com/AGB.pdf](http://www.gogatec.com/AGB.pdf), techn. Änderungen vorbehalten /  
terms & conditions can be found on our website: [www.gogatec.com/AGB.pdf](http://www.gogatec.com/AGB.pdf); error, technical modifications and variations are reserved

**Kleinkabelschuhe isoliert Nylon transparent /**  
*insulated mini cable lugs nylon transparent*

**GOGAPIN KKS3-FV Flachsteckhülse mit Abzweig isoliert, easy entry /**  
*insulated piggy back disconnects disconnects, easy entry*

Material: Messing, gal. verzinkt / brass tin-plated  
 Isolation / insulation: Nylon transparent / nylon transparent  
 Temperaturbereich / temperature range: -60°C bis +105°C  
 Zulassung / approval: UL listed  
 Rohr/Hals gelötet / tube brazed

**Nylon**

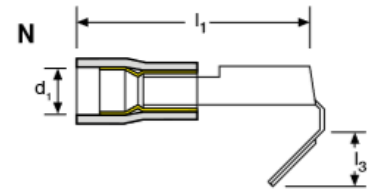

**Passende Werkzeuge siehe GOGATOOL Katalog / for appropriate tools please see GOGATOOL catalog**

| FC | Typ              | Bereich         | Steckgröße | Abmessung mm  |     |     |     | VPE  | ArtNr          | €         |
|----|------------------|-----------------|------------|---------------|-----|-----|-----|------|----------------|-----------|
|    | type             | mm <sup>2</sup> | mm         | l1            | d1  | l3  | s   | Stk. |                | /100 Stk. |
|    |                  | range           | tab size   | dimensions mm |     |     |     | PU   |                | /100 pcs. |
| RT | KKS3-FV-1,5-6308 | 0,5 - 1,5       | 6,3 - 0,8  | 22,5          | 4,1 | 8,2 | 0,4 | 100  | 12126000156308 | 20,36     |
| BL | KKS3-FV-2,5-6308 | 1,5 - 2,5       | 6,3 - 0,8  | 23,0          | 5,0 | 8,2 | 0,4 | 100  | 12126000256308 | 14,48     |
| GE | KKS3-FV-6,0-6308 | 4,0 - 6,0       | 6,3 - 0,8  | 26,0          | 6,6 | 8,2 | 0,4 | 100  | 12126000606308 | 17,71     |



Preise gültig ab 01.01.2024 exkl. MwSt., freibleibend, Auftragsrabatt auf Anfrage /  
 prices are valid from 01.01.2024 excl. VAT, subject to change, discounts upon request  
 sonst. Konditionen siehe [www.gogatec.com/AGB.pdf](http://www.gogatec.com/AGB.pdf), techn. Änderungen vorbehalten /  
 terms & conditions can be found on our website: [www.gogatec.com/AGB.pdf](http://www.gogatec.com/AGB.pdf); error, technical modifications and variations are reserved