USB Driver

Installation Procedure Manual

**Supported Models: PHC-D08
PHE-3FB2**

Supported OS: **Windows 7 (32bit, 64bit)**
 Windows 8(32bit, 64bit)
 Windows 8.1(32bit, 64bit)
 Windows 10(32bit, 64bit)
 Windows Server 2008 R2
 Windows Server 2012
 Windows Server 2012 R2

<Regarding Trademarks and Licenses>

Microsoft Windows is a registered trademark of the Microsoft Corporation in the U.S. and other countries.

Windows 7, Windows 8, Windows 8.1, Windows 10, Windows Server 2008 R2, Windows Server 2012, Windows Server 2012 R2 are registered trademarks of the Microsoft Corporation in the U.S. and other countries.

The company and product names indicated in this manual are trademarks and registered trademarks of each company.

Table of Contents

1. Windows 7	3
1. Driver Installation	3
2. Connecting the Product	5
3. Driver Uninstallation.....	7
2. Windows 8, Windows 8.1	9
1. Driver Installation	9
2. Connecting the Product	11
3. Driver Uninstallation.....	13
3. Windows 10	15
1. Driver Installation	15
2. Connecting the Product	17
3. Driver Uninstallation.....	19
4. Windows Server 2008 R2	22
1. Driver Installation	22
2. Connecting the Product	24
3. Driver Uninstallation.....	26
5. Windows Server 2012, Windows Server 2012 R2	28
1. Driver Installation	28
2. Connecting the Product	30
3. Driver Uninstallation.....	32

1. Windows 7

1. Driver Installation

1. Download and extract the "Setup.bat" file in an arbitrary folder, such as "My Document", and double-click the file.

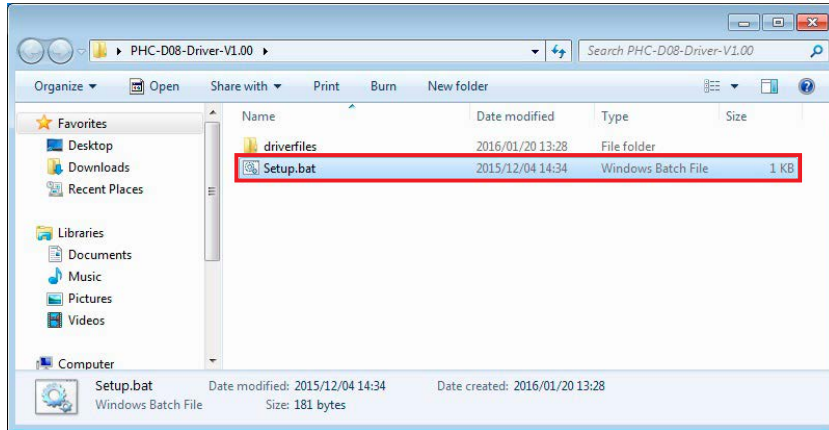

2. If a screen displays a message, "User Account Control", click "YES" to continue.

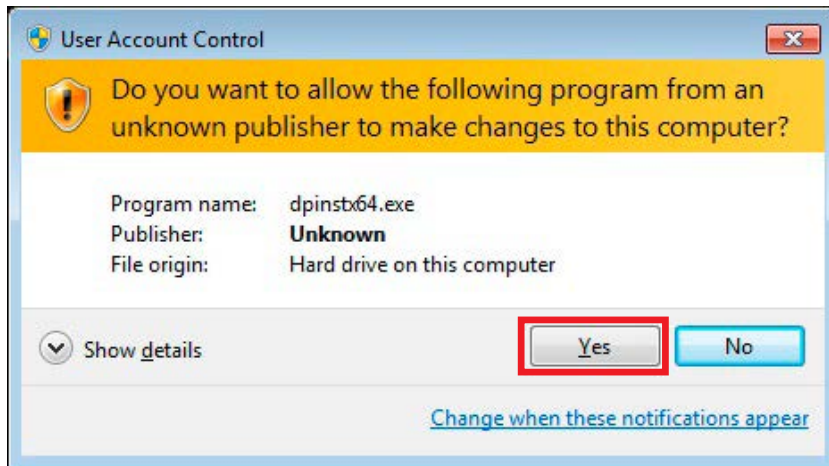

3. Click "Next" to continue.

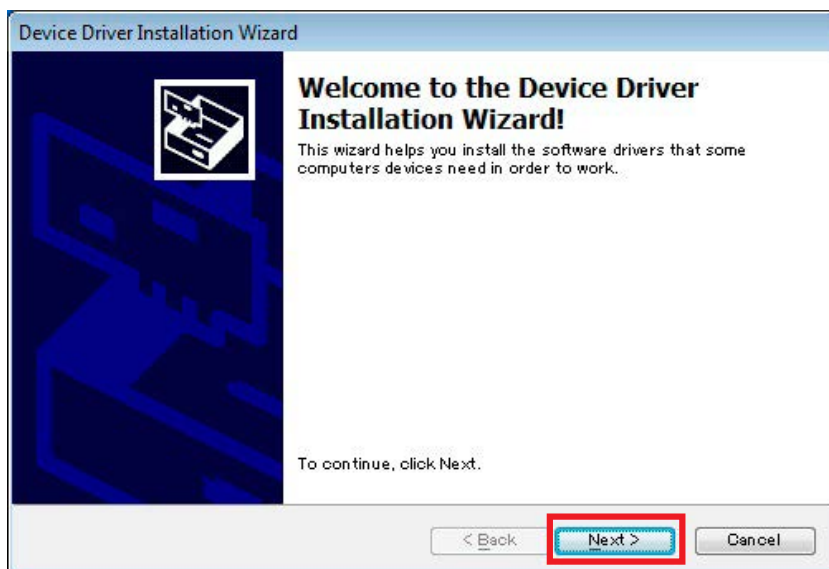

4. The driver installation is started with an Installation Wizard.

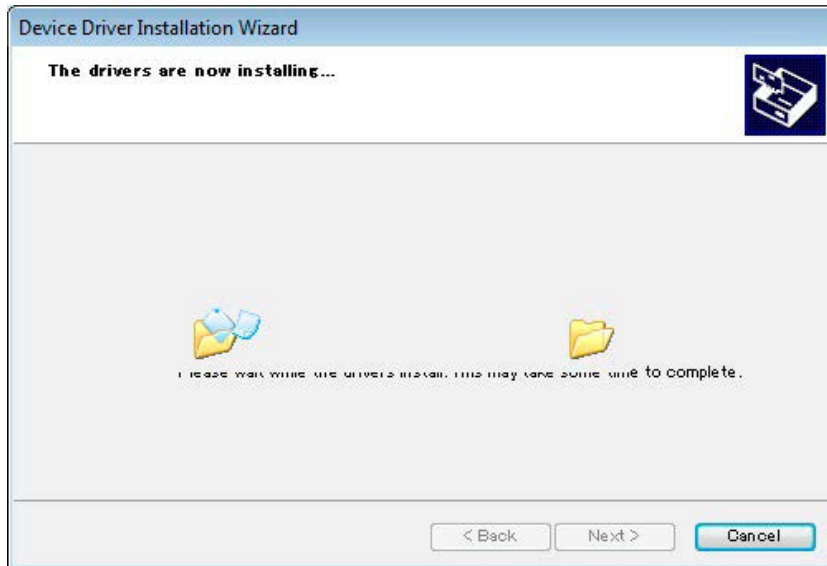

5. If a Windows Security window is prompted, click "Install" to continue.

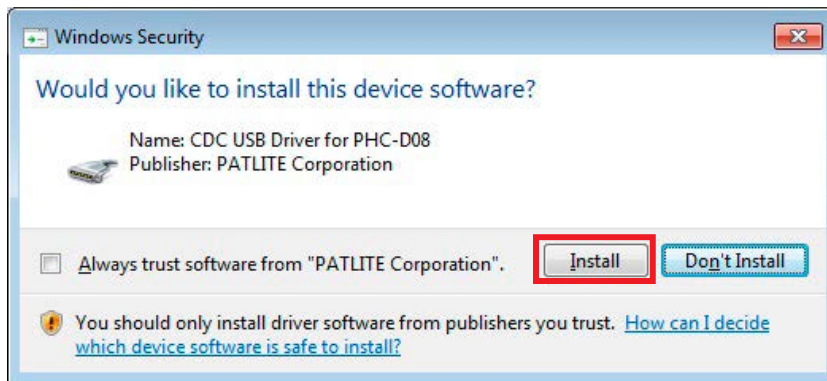

6. Click "Finish" to complete the installation.



The driver installation is completed.

By installing this driver, the USB port is managed as a virtual COM port, therefore can be controlled the same as an RS-232C port.

2. Connecting the Product

1. Connect a personal computer to this product with a USB cable.
A dialog window will pop-up after connection.

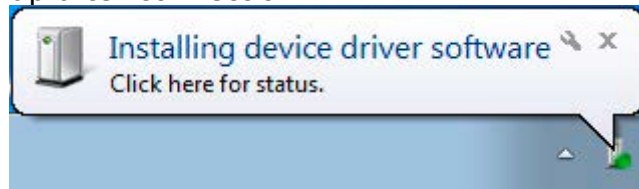

2. After awhile, "Device driver software installed successfully." will be displayed.

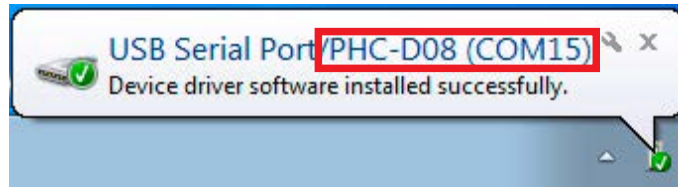

- * Make sure the model number of the connected equipment is displayed.
3. Click "Hardware and Sound" in the "Control Panel" when connecting the equipment.
(View the Control Panel as a "category")

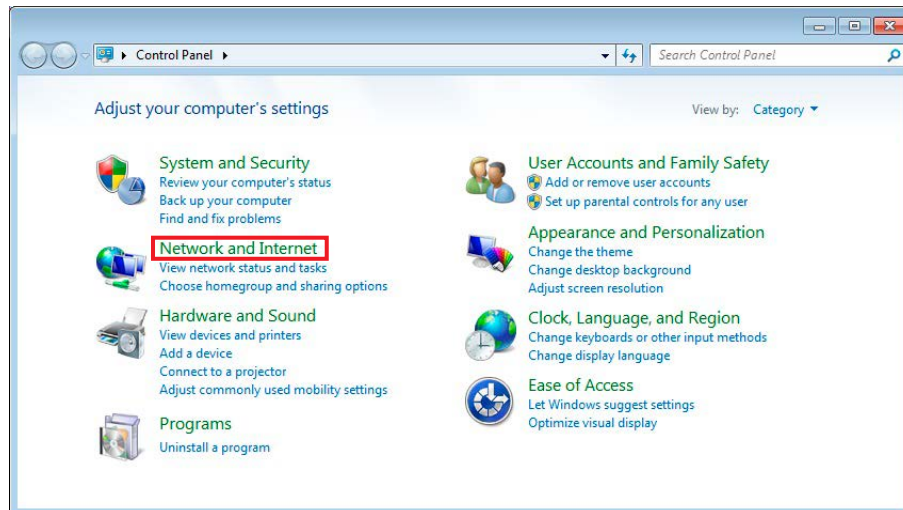

4. Click the "Device Manager" under the "Devices and Printers" section.

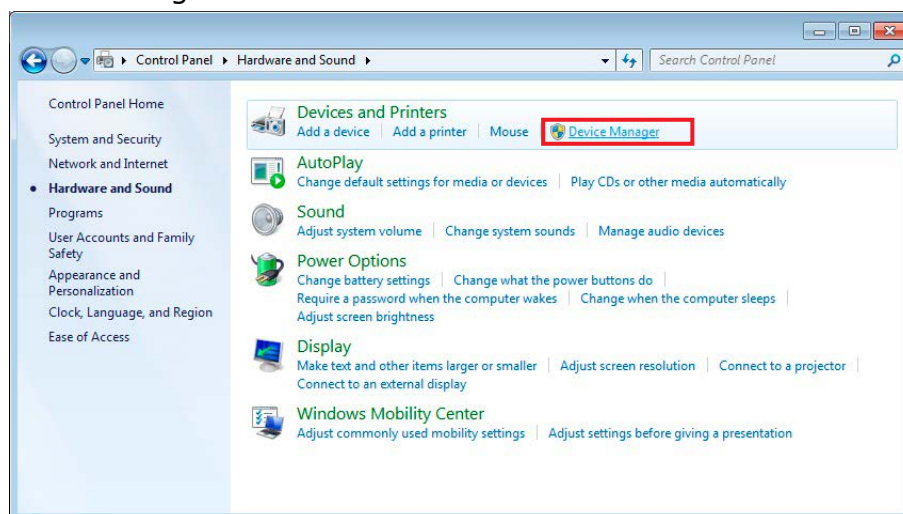

5. In the Ports (COM and LPT), the "USB Serial Port/PHC-D08 (COM*)" should be displayed.
(For the PHE-3FB2 Model, "USB Serial Port/PHE-3FB2 (COM*)" should be displayed)

* The "(COM*)" is the number to use at the end of the command to control the equipment.

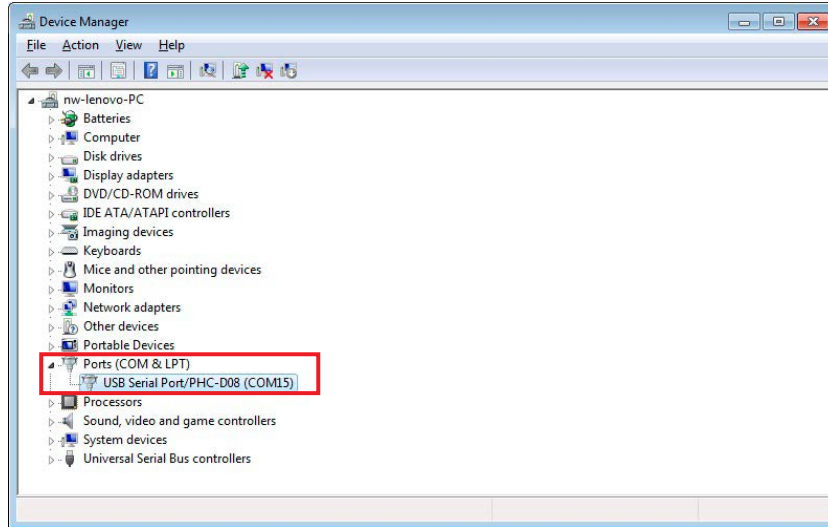

Connection of the product is complete.

3.Driver Uninstallation

1. Click "Hardware and Sound" in the "Control Panel" when connecting the equipment. (View the Control Panel as a "category")

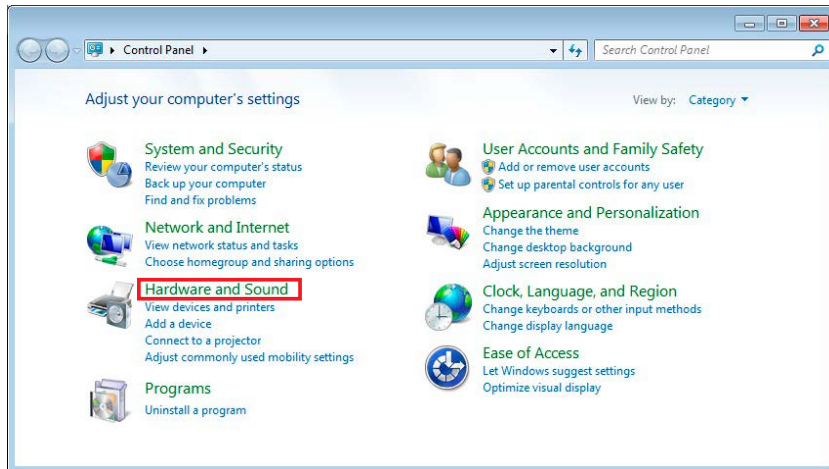

2. Click the "Device Manager" under the "Devices and Printers" section.

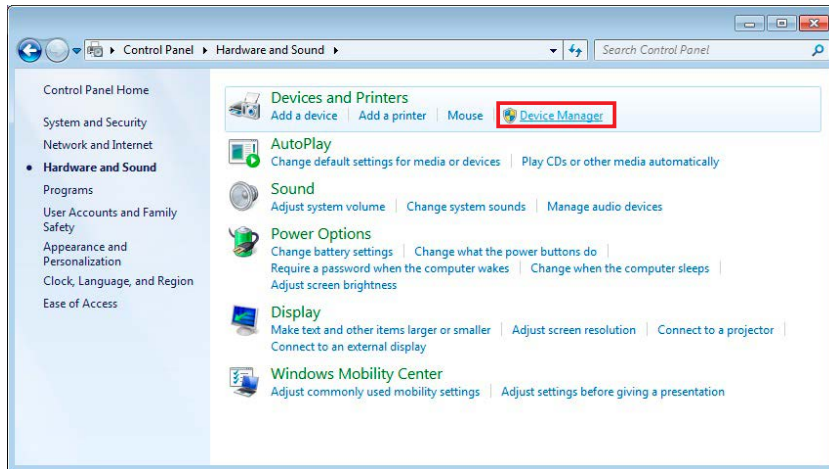

3. Check that the "USB Serial Port/PHC-D08 (COM*)" is displayed.

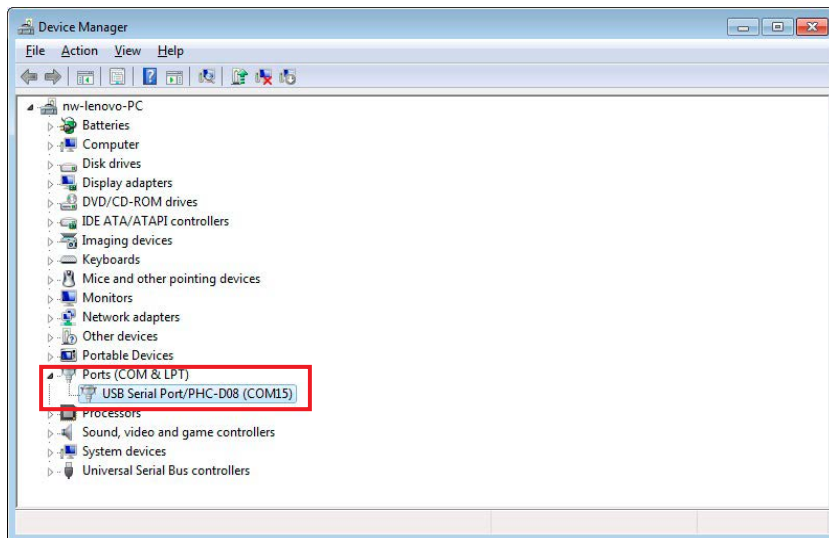

* Make sure the connected product model is displayed after the "USB Serial Port/" prefix.

4. Right-click on the "USB Serial Port/****" and click "Uninstall" to delete.

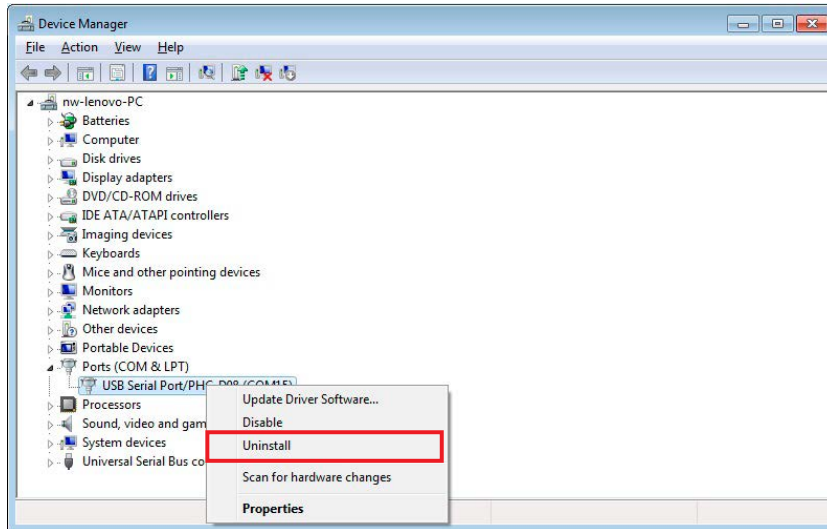

5. Put a check in the box for "Delete the driver software for this device", then click "OK" to continue.



Driver Uninstallation is completed.

2. Windows 8, Windows 8.1

1. Driver Installation

1. Download and extract the "Setup.bat" file in an arbitrary folder, such as "My Document", and double-click the file.

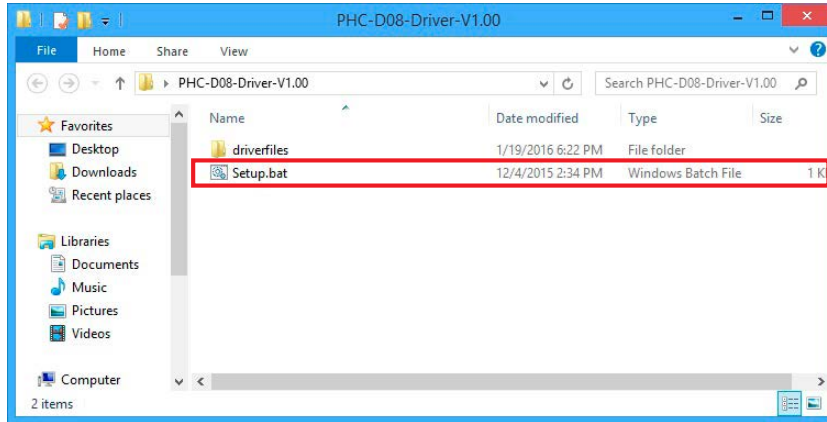

2. If a screen displays a message, "User Account Control", click "YES" to continue.

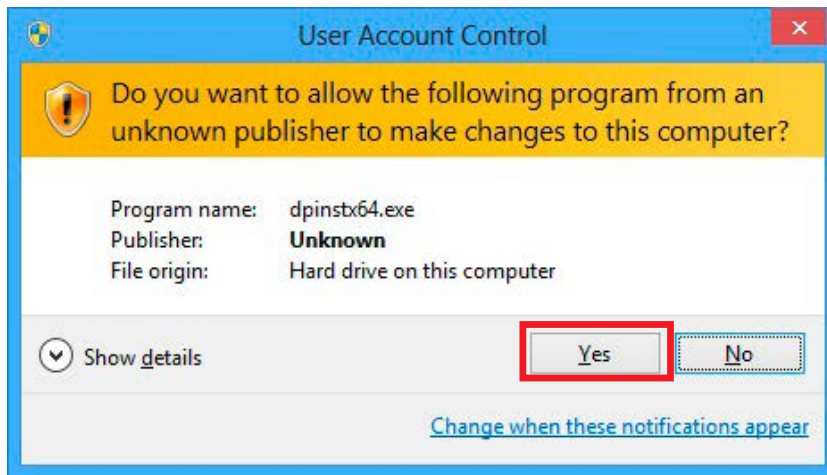

3. Click "Next" to continue.



4. The driver installation is started with an Installation Wizard.



5. If a Windows Security window is prompted, click "Install" to continue.

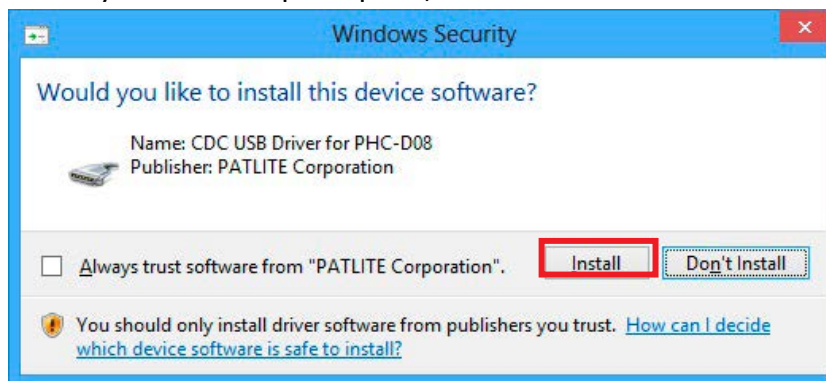

6. Click "Finish" to complete the installation.



The driver installation is completed.

By installing this driver, the USB port is managed as a virtual COM port, therefore can be controlled the same as an RS-232C port.

2. Connecting the Product

1. Connect a personal computer to this product with a USB cable.
Connection to the device will be set up automatically.

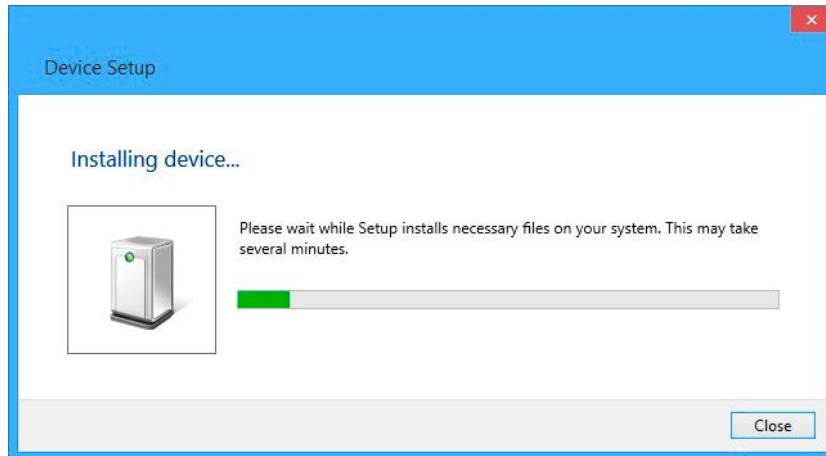

2. Click "Hardware and Sound" in the "Control Panel" when connecting the equipment.
(View the Control Panel as a "category")

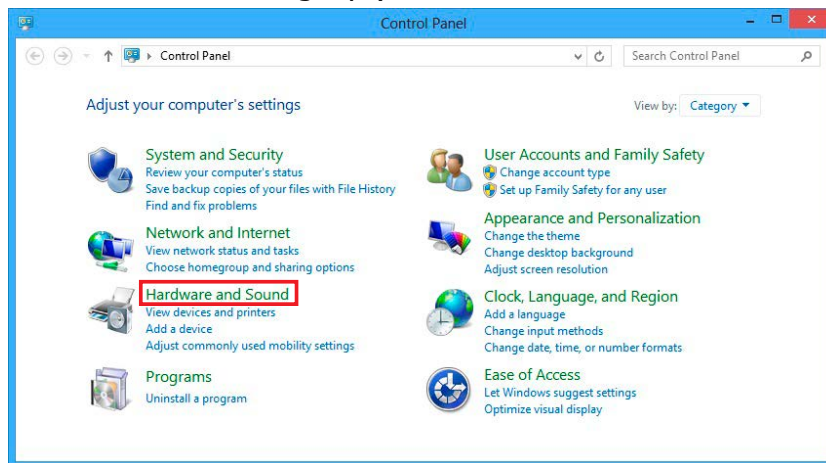

3. Click the "Device Manager" under the "Devices and Printers" section.

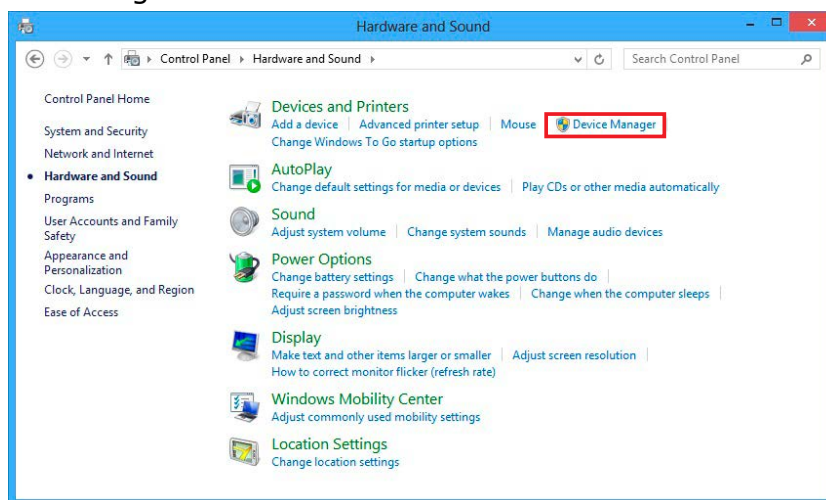

4. In the Ports (COM and LPT), the "USB Serial Port/PHC-D08 (COM*)" should be displayed.
(For the PHE-3FB2 Model, "USB Serial Port/PHE-3FB2 (COM*)" should be displayed)
- * The "(COM*)" is the number to use at the end of the command to control the equipment.

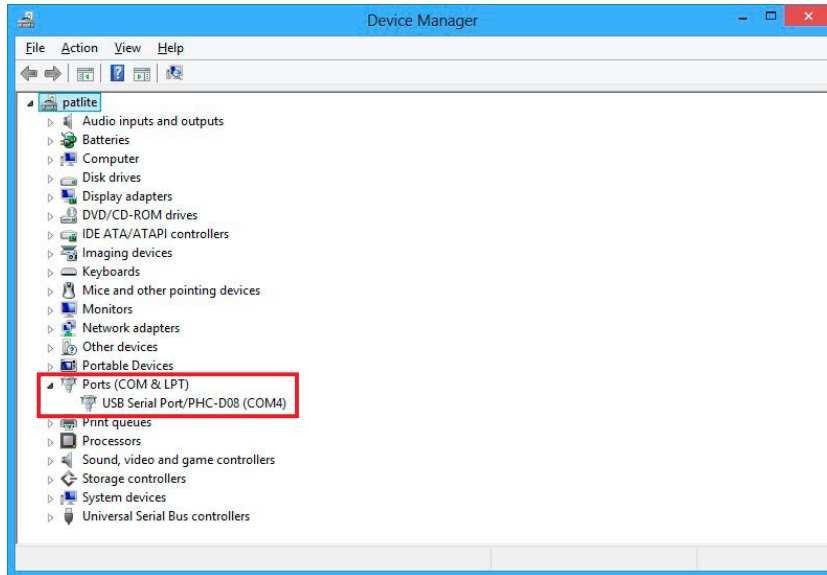

Connection of the product is complete.

3.Driver Uninstallation

1. Click "Hardware and Sound" in the "Control Panel" when connecting the equipment. (View the Control Panel as a "category")

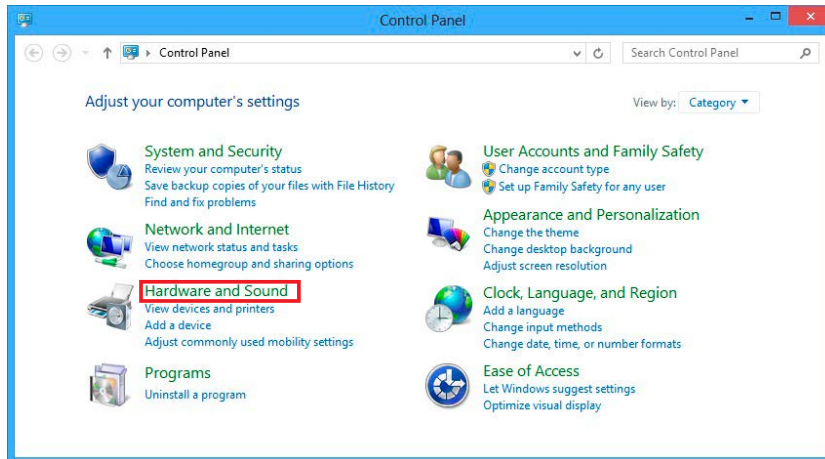

2. Click the "Device Manager" under the "Devices and Printers" section.

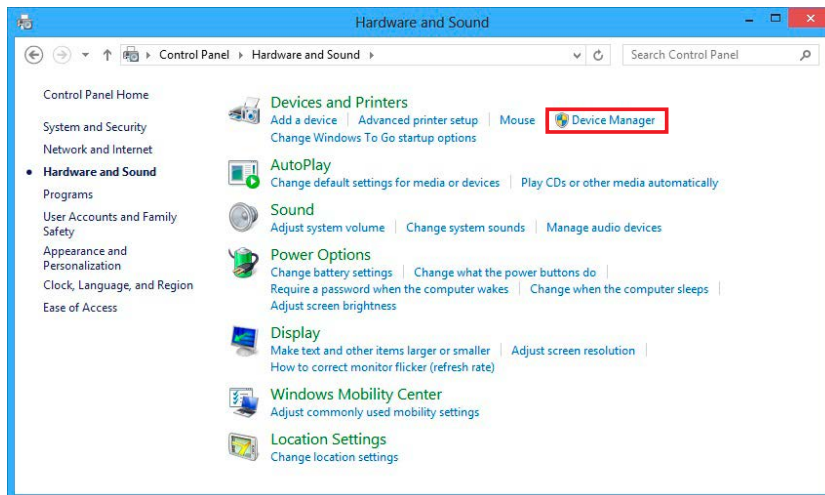

3. Check that the "USB Serial Port/PHC-D08 (COM*)" is displayed.

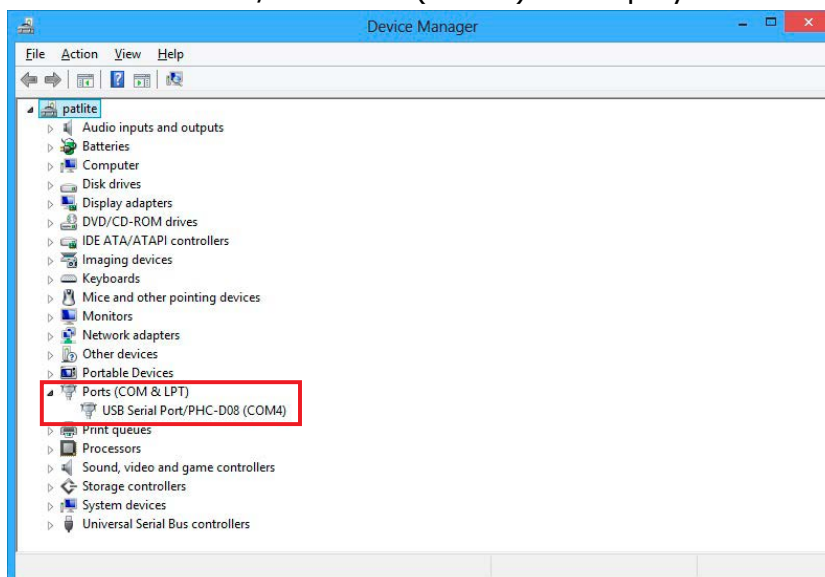

* Make sure the connected product model is displayed after the "USB Serial Port/" prefix.

4. Right-click on the "USB Serial Port/*****" and click "Uninstall" to delete.

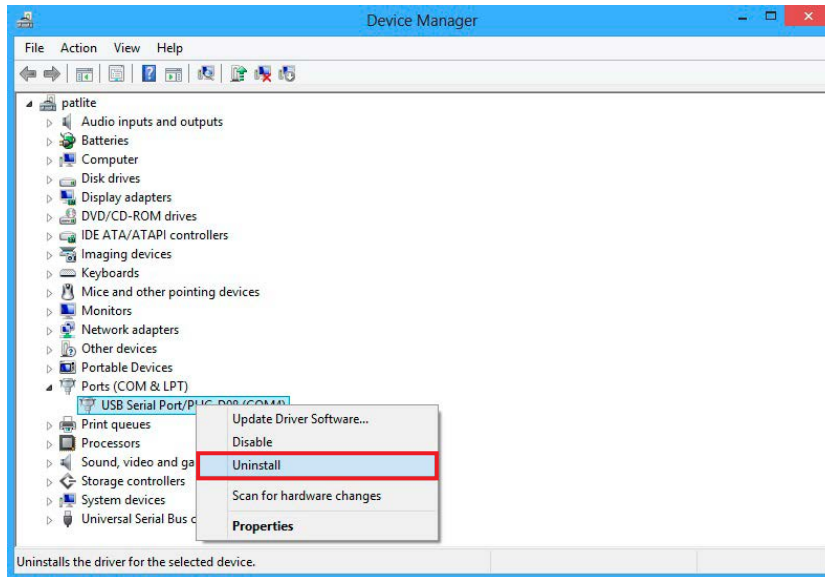

5. Put a check in the box for "Delete the driver software for this device", then click "OK" to continue.



Driver Uninstallation is completed.

3. Windows 10

1. Driver Installation

1. Download and extract the "Setup.bat" file in an arbitrary folder, such as "My Document", and double-click the file.

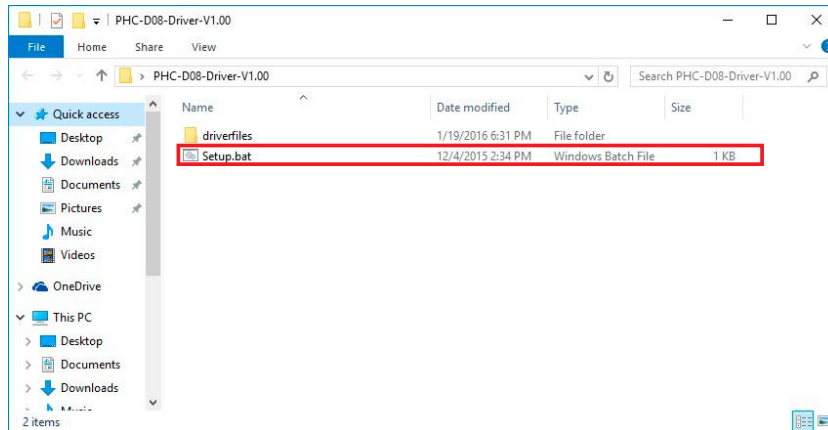

2. If a screen displays a message, "User Account Control", click "YES" to continue.

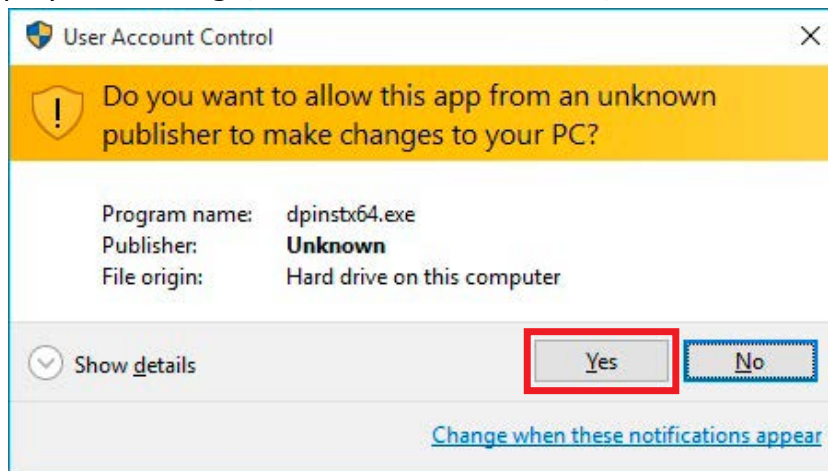

3. Click "Next" to continue.

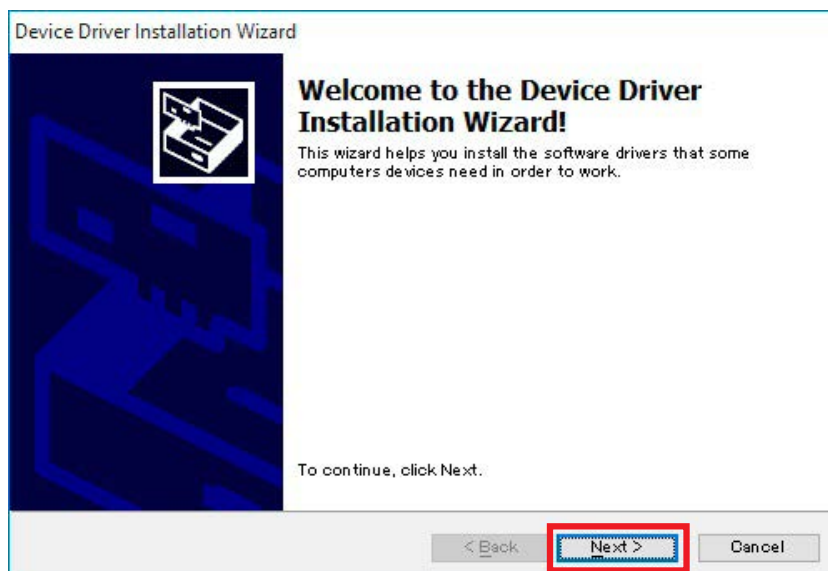

4. The driver installation is started with an Installation Wizard.

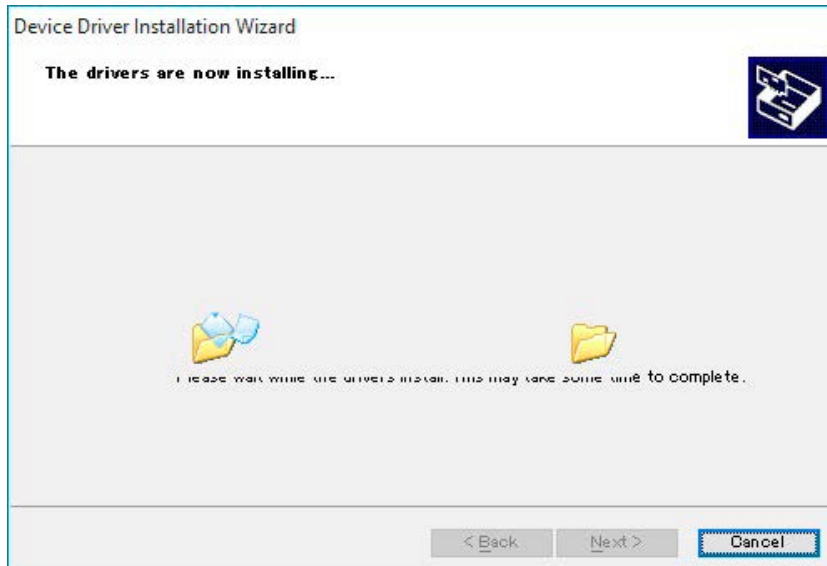

5. If a Windows Security window is prompted, click "Install" to continue.

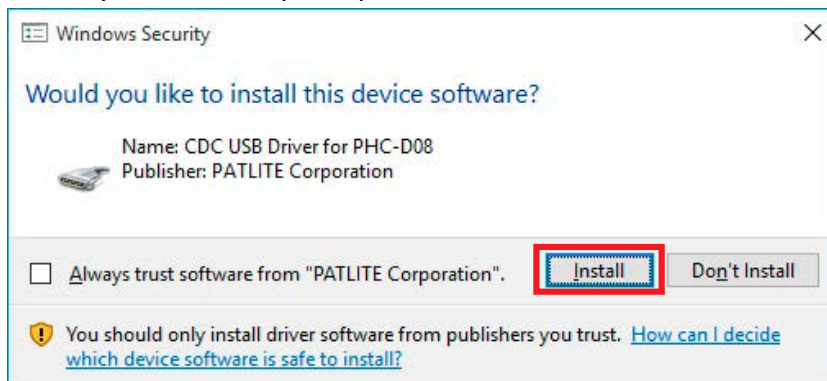

6. Click "Finish" to complete the installation.

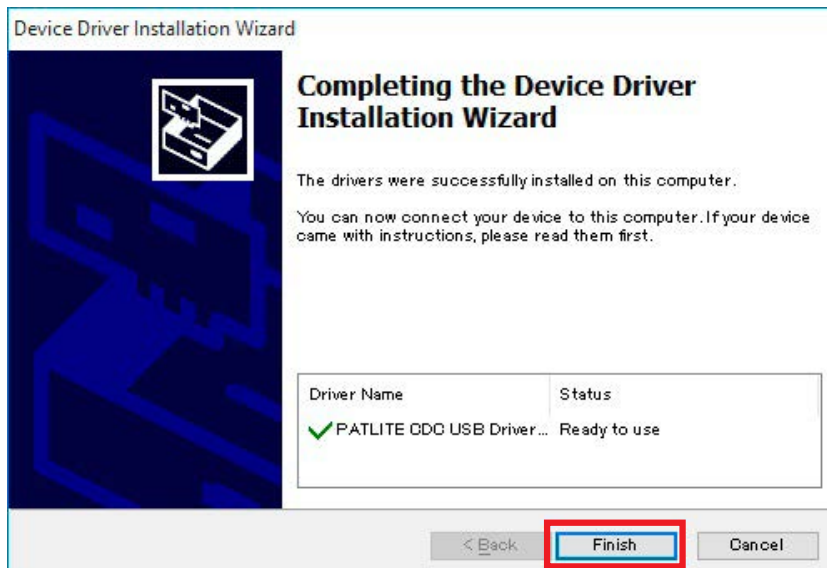

The driver installation is completed.

By installing this driver, the USB port is managed as a virtual COM port, therefore can be controlled the same as an RS-232C port.

2. Connecting the Product

1. Connect a personal computer to this product with a USB cable.
Connection to the device will be set up automatically.

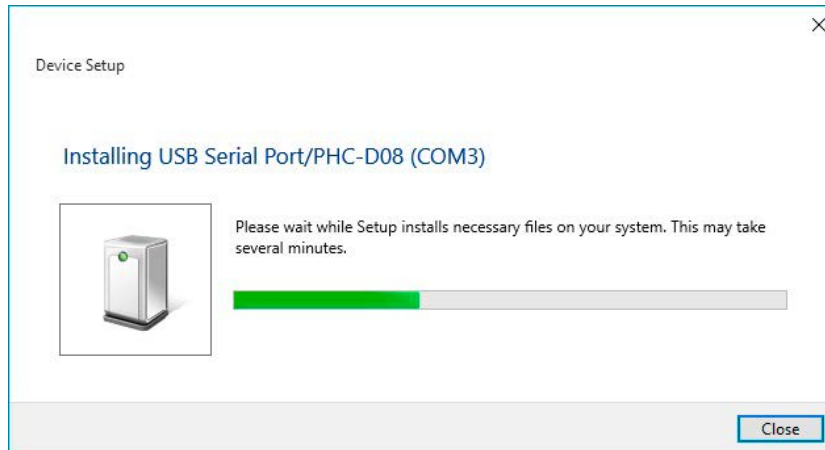

2. Click "Hardware and Sound" in the "Control Panel" when connecting the equipment.
(View the Control Panel as a "category")

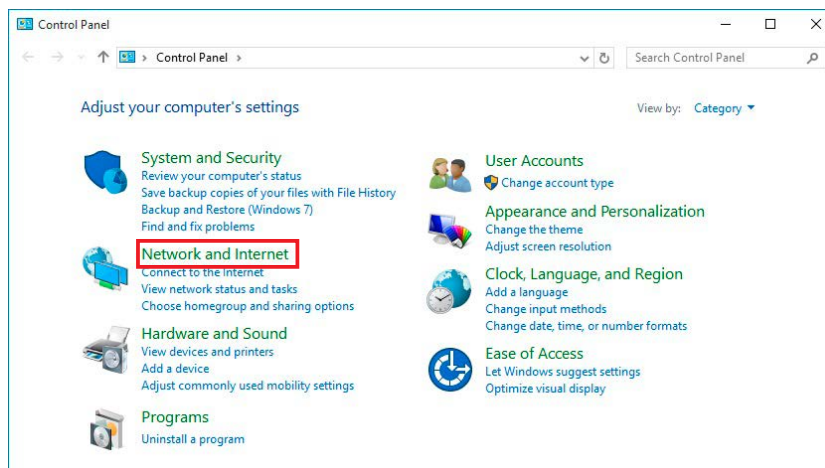

3. Click the "Device Manager" under the "Devices and Printers" section.

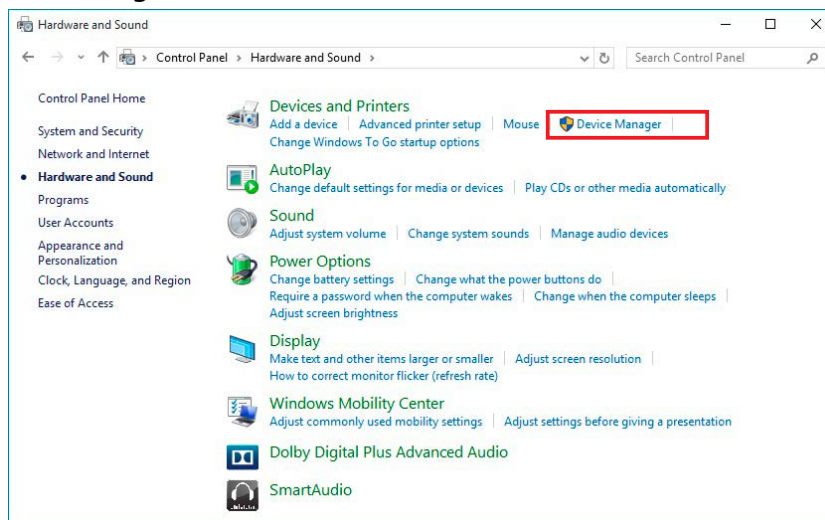

4. In the Ports (COM and LPT), the "USB Serial Port/PHC-D08 (COM*)" should be displayed.
(For the PHE-3FB2 Model, "USB Serial Port/PHE-3FB2 (COM*)" should be displayed)
- * The "(COM*)" is the number to use at the end of the command to control the equipment.

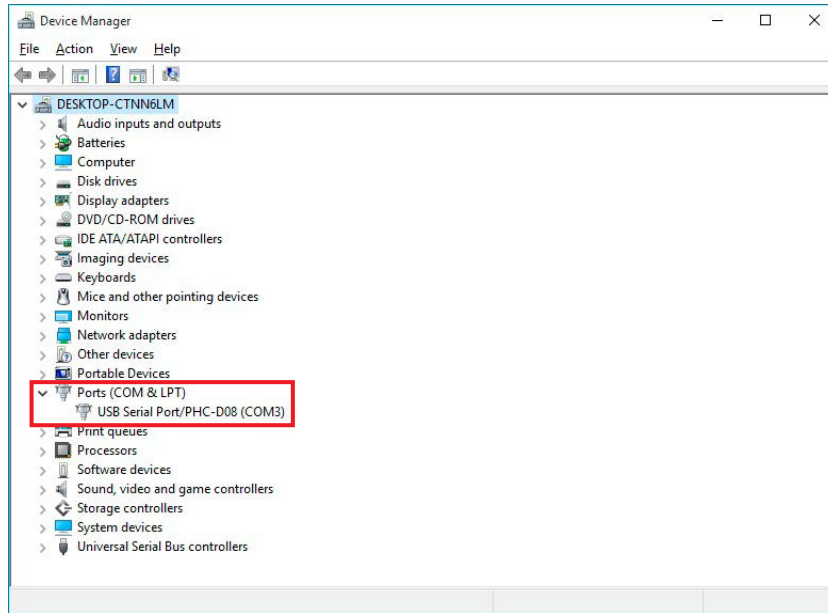

Connection of the product is complete.

3.Driver Uninstallation

1. Click "Hardware and Sound" in the "Control Panel" when connecting the equipment. (View the Control Panel as a "category")

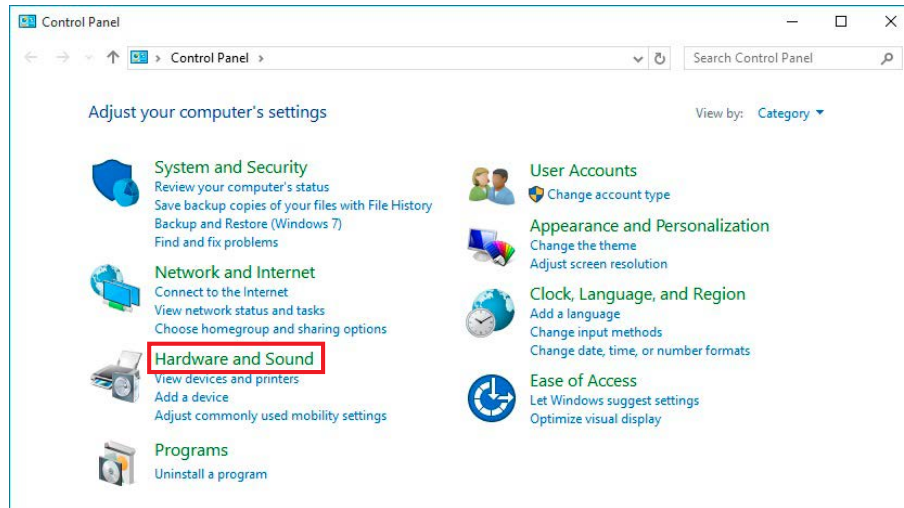

2. Click the "Device Manager" under the "Devices and Printers" section.

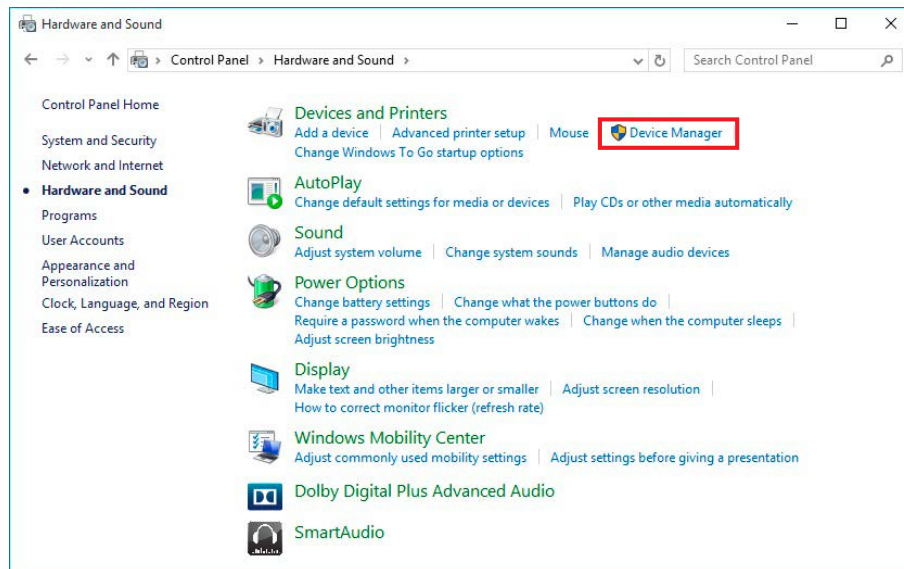

3. Check that the "USB Serial Port/PHC-D08 (COM*)" is displayed.

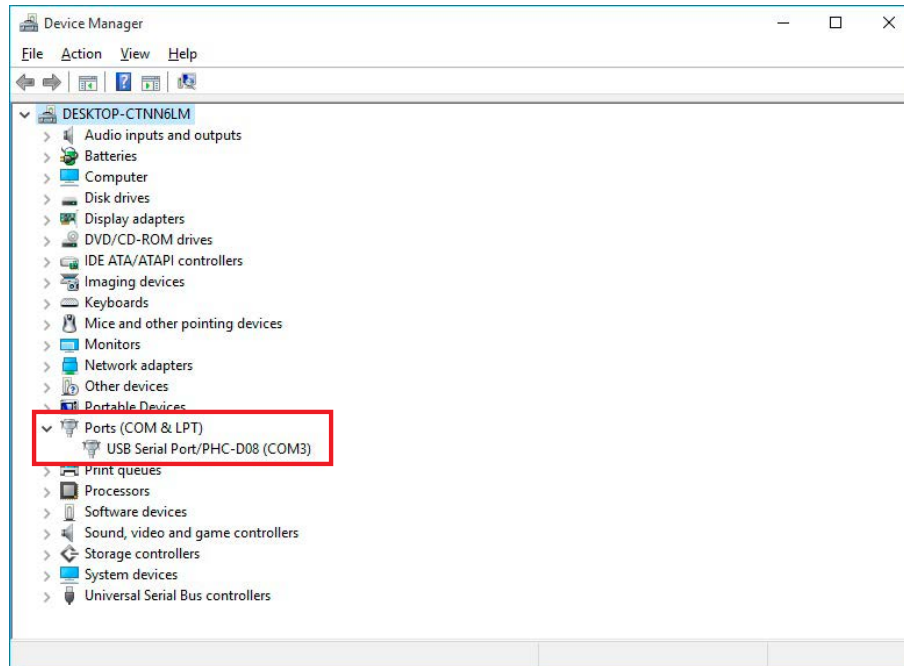

* Make sure the connected product model is displayed after the "USB Serial Port/" prefix.

4. Right-click on the "USB Serial Port/****" and click "Uninstall" to delete.

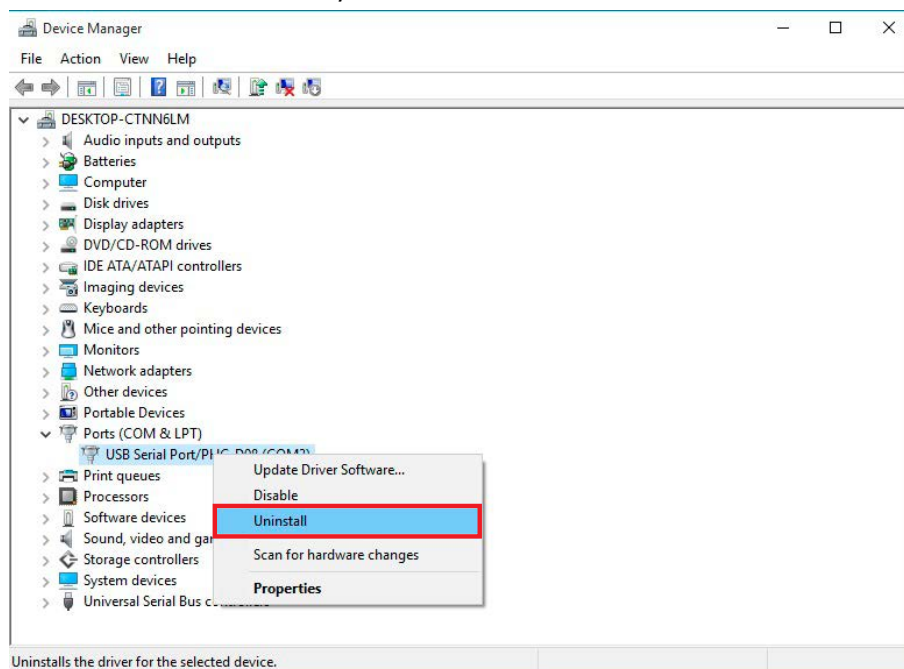

- Put a check in the box for "Delete the driver software for this device", then click "OK" to continue.



Driver Uninstallation is completed.

4. Windows Server 2008 R2

1. Driver Installation

1. Download and extract the "Setup.bat" file in an arbitrary folder, such as "My Document", and double-click the file.

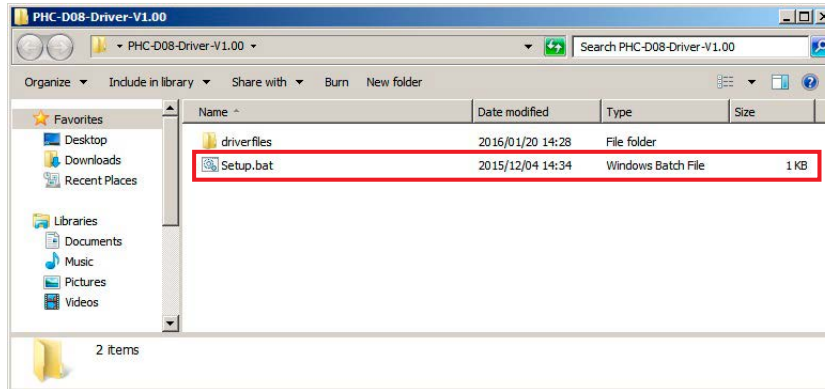

2. Click "Next" to continue.



3. The driver installation is started with an Installation Wizard.

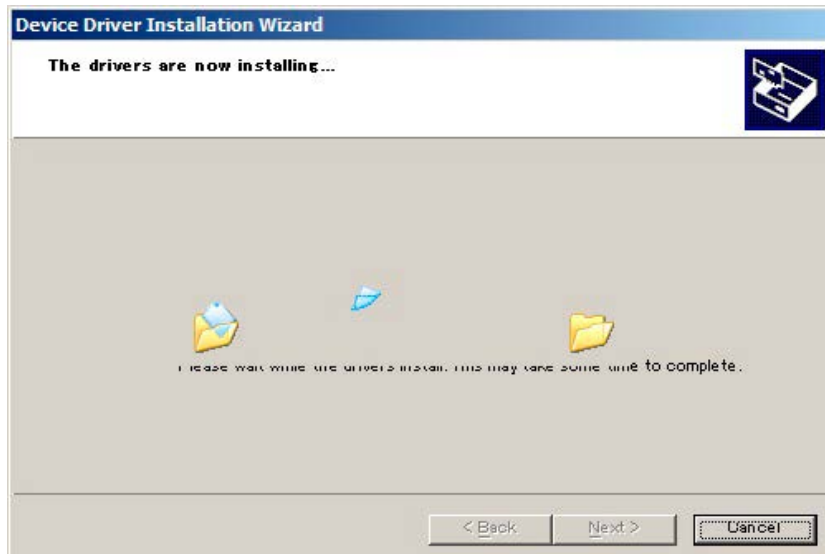

4. When the "Windows Security" is displayed, click "Install this driver software anyway" to continue.

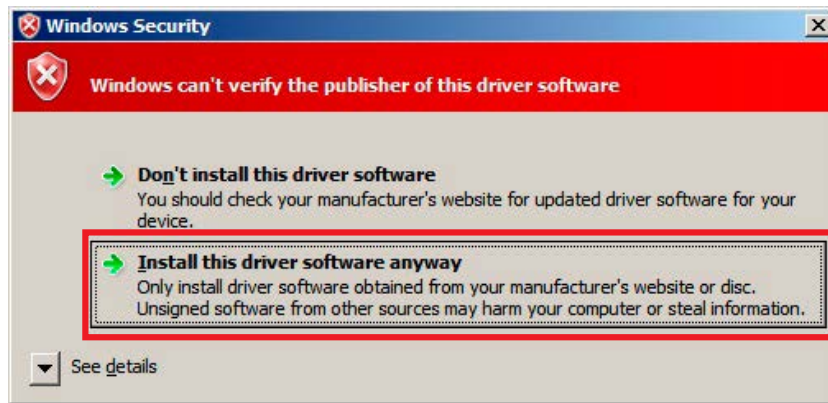

5. Click "Finish" to complete the installation.



The driver installation is completed.

By installing this driver, the USB port is managed as a virtual COM port, therefore can be controlled the same as an RS-232C port.

2. Connecting the Product

1. Connect a personal computer to this product with a USB cable.
A dialog window will pop-up after connection.

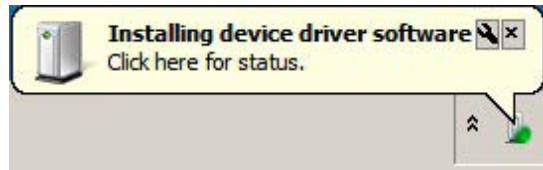

2. After awhile, "Device driver software installed successfully." will be displayed.

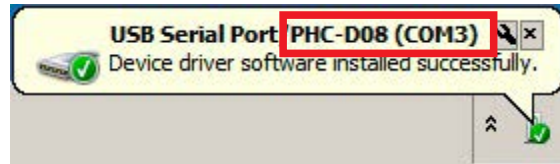

* Make sure the model number of the connected equipment is displayed.

3. Click "Hardware" in the "Control Panel" when connecting the equipment. (View the Control Panel as a "category")

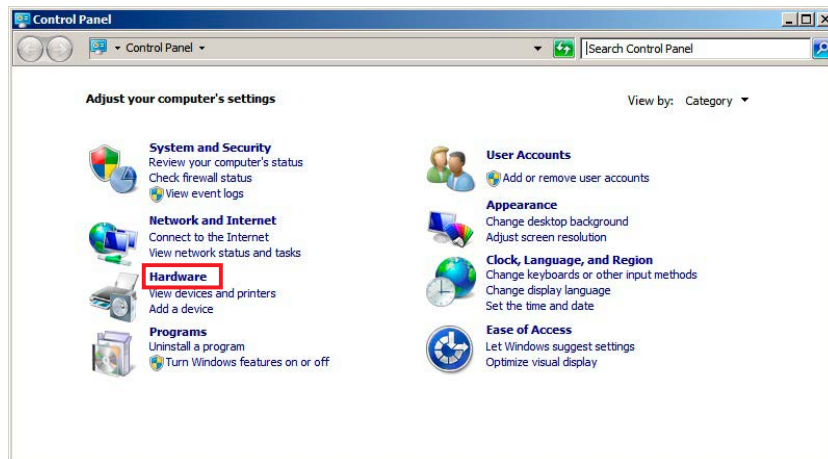

4. Click the "Device Manager" under the "Devices and Printers" section.

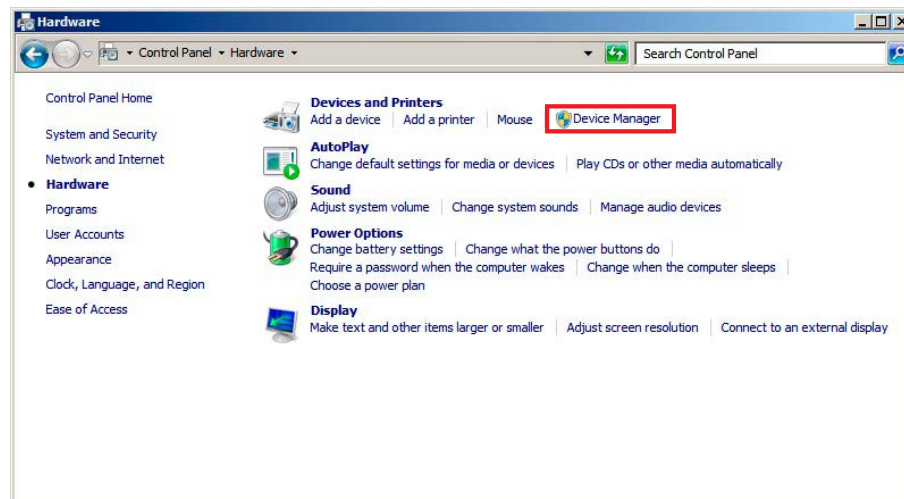

5. In the Ports (COM and LPT), the "USB Serial Port/PHC-D08 (COM*)" should be displayed.
(For the PHE-3FB2 Model, "USB Serial Port/PHE-3FB2 (COM*)" should be displayed)
- * The "(COM*)" is the number to use at the end of the command to control the equipment.

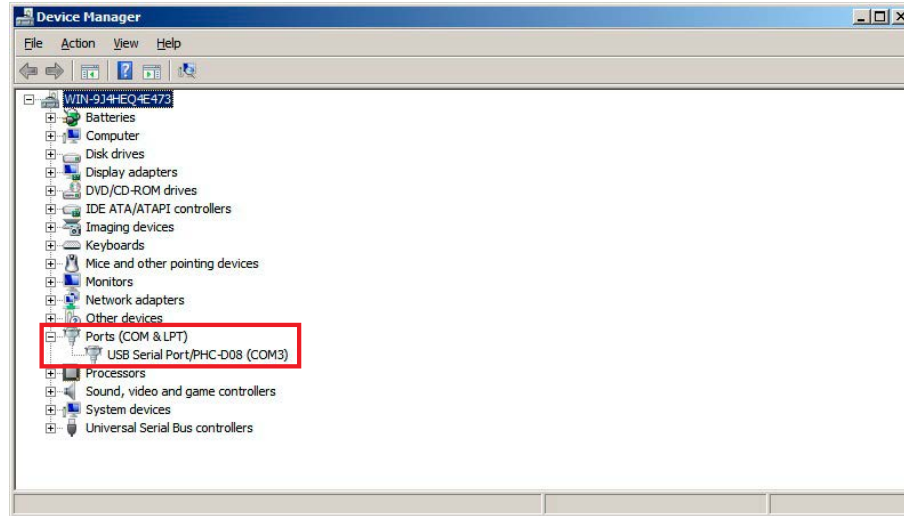

Connection of the product is complete.

3.Driver Uninstallation

1. Click "Hardware" in the "Control Panel" when connecting the equipment. (View the Control Panel as a "category")

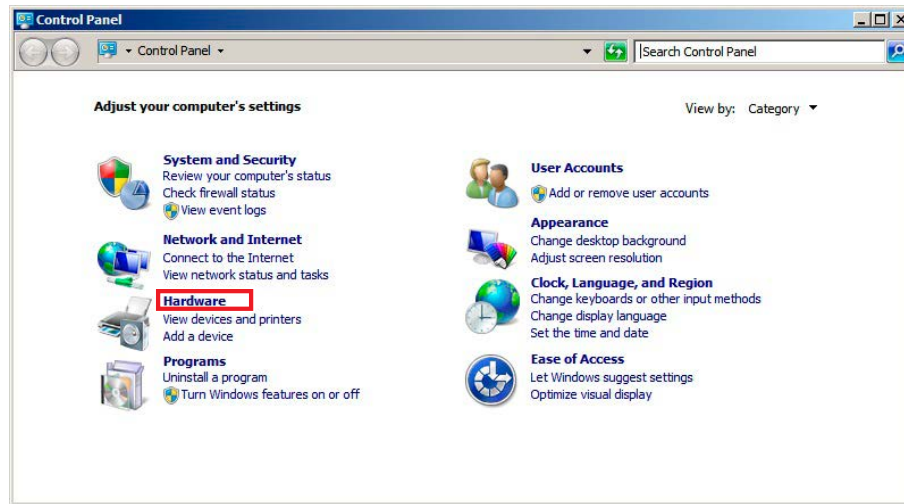

2. Click the "Device Manager" under the "Devices and Printers" section.

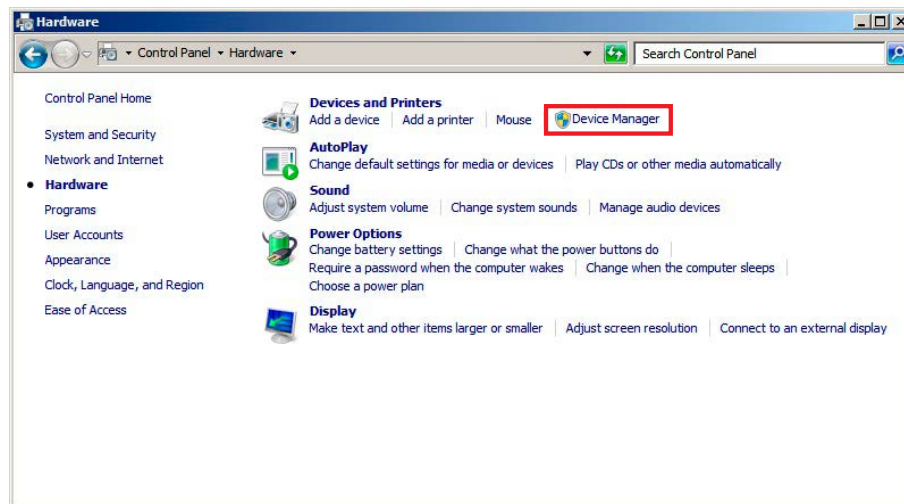

3. Check that the "USB Serial Port/PHC-D08 (COM*)" is displayed.

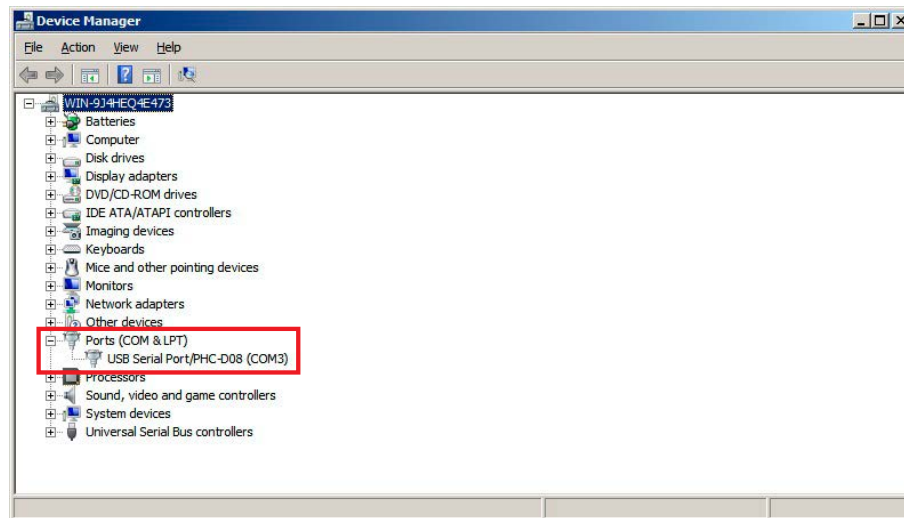

* Make sure the connected product model is displayed after the "USB Serial Port/" prefix.

4. Right-click on the "USB Serial Port/*****" and click "Uninstall" to delete.

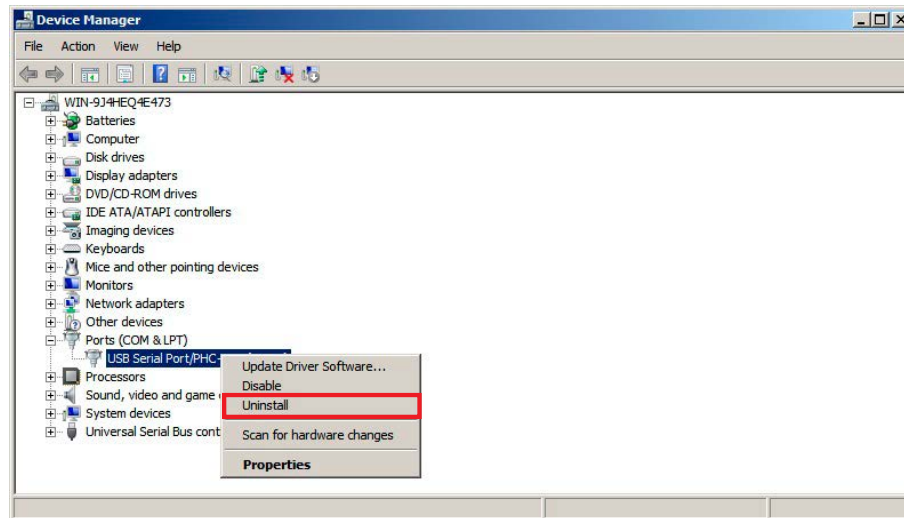

5. Put a check in the box for "Delete the driver software for this device", then click "OK" to continue.

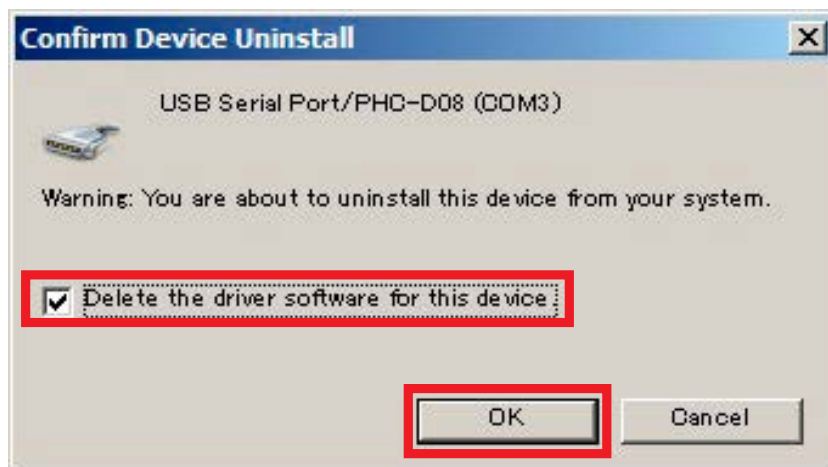

Driver Uninstallation is completed.

5. Windows Server 2012, Windows Server 2012 R2

1. Driver Installation

1. Download and extract the "Setup.bat" file in an arbitrary folder, such as "My Document", and double-click the file.

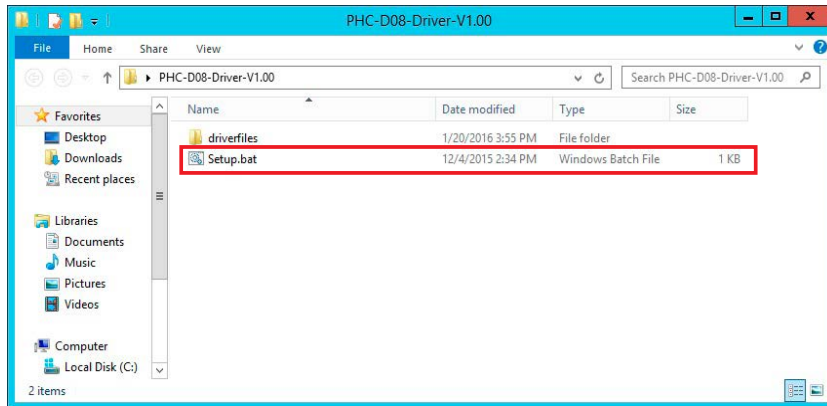

2. Click "Next" to continue.



3. The driver installation is started with an Installation Wizard.



4. If a Windows Security window is prompted, click "Install" to continue.



5. Click "Finish" to complete the installation.



The driver installation is completed.

By installing this driver, the USB port is managed as a virtual COM port, therefore can be controlled the same as an RS-232C port.

2. Connecting the Product

1. Connect a personal computer to this product with a USB cable.
Connection to the device will be set up automatically.

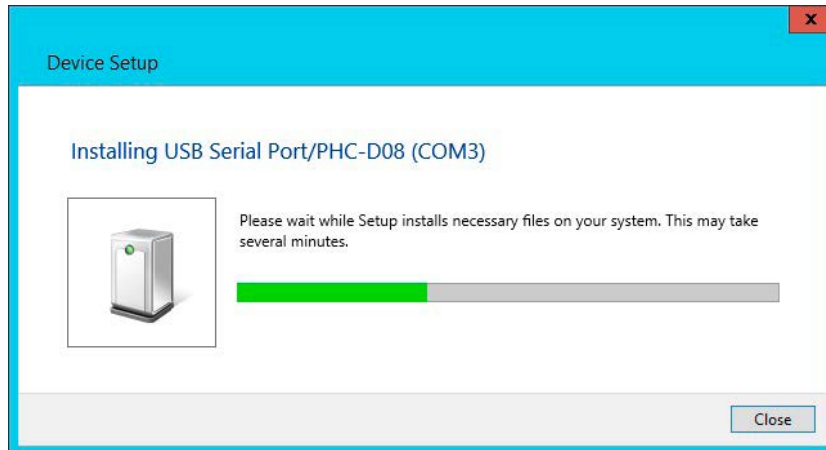

2. Click "Hardware" in the "Control Panel" when connecting the equipment. (View the Control Panel as a "category")

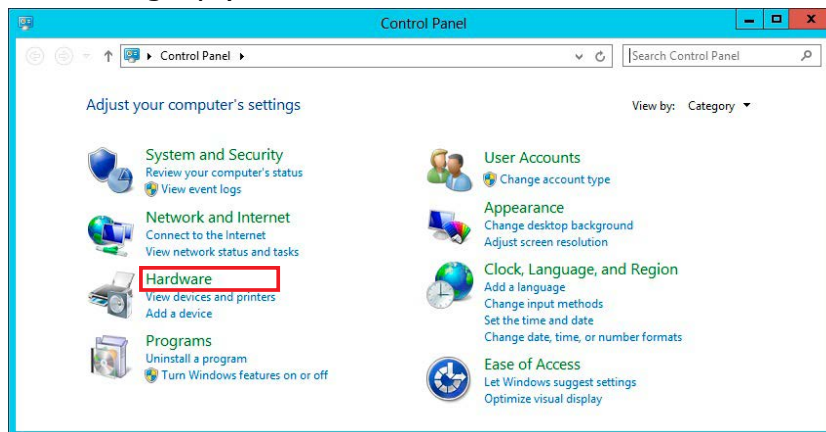

3. Click the "Device Manager" under the "Devices and Printers" section.

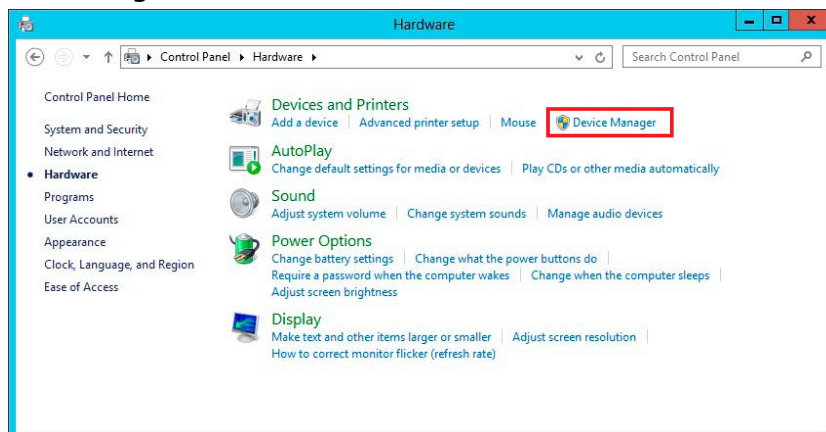

4. In the Ports (COM and LPT), the "USB Serial Port/PHC-D08 (COM*)" should be displayed.
(For the PHE-3FB2 Model, "USB Serial Port/PHE-3FB2 (COM*)" should be displayed)
- * The "(COM*)" is the number to use at the end of the command to control the equipment.

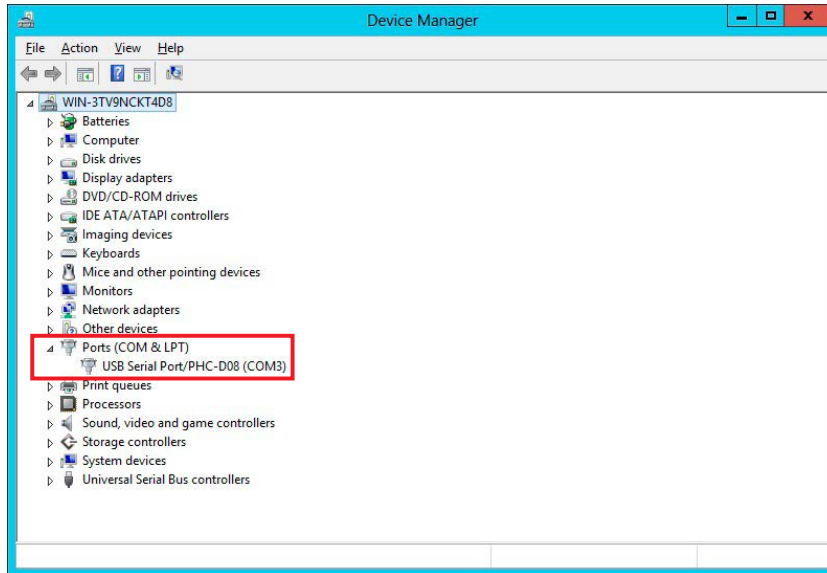

Connection of the product is complete.

3.Driver Uninstallation

1. Click "Hardware" in the "Control Panel" when connecting the equipment. (View the Control Panel as a "category")

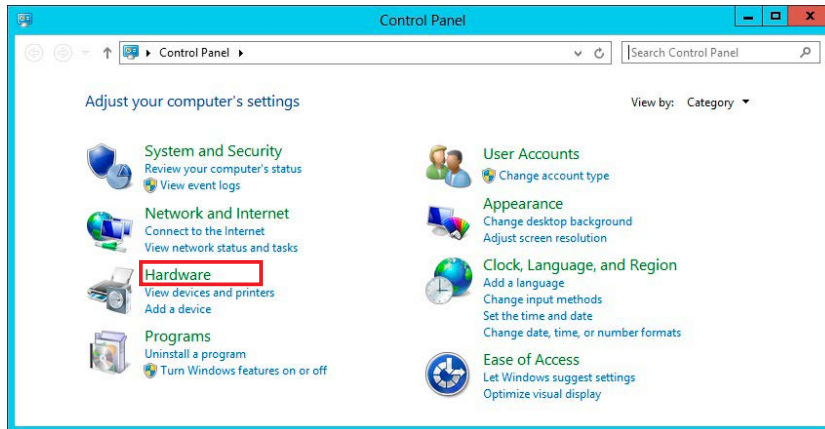

2. Click the "Device Manager" under the "Devices and Printers" section.

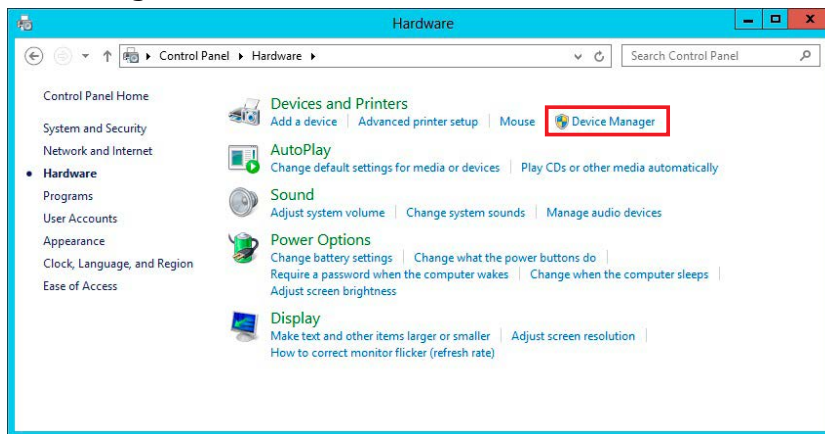

3. Check that the "USB Serial Port/PHC-D08 (COM*)" is displayed.

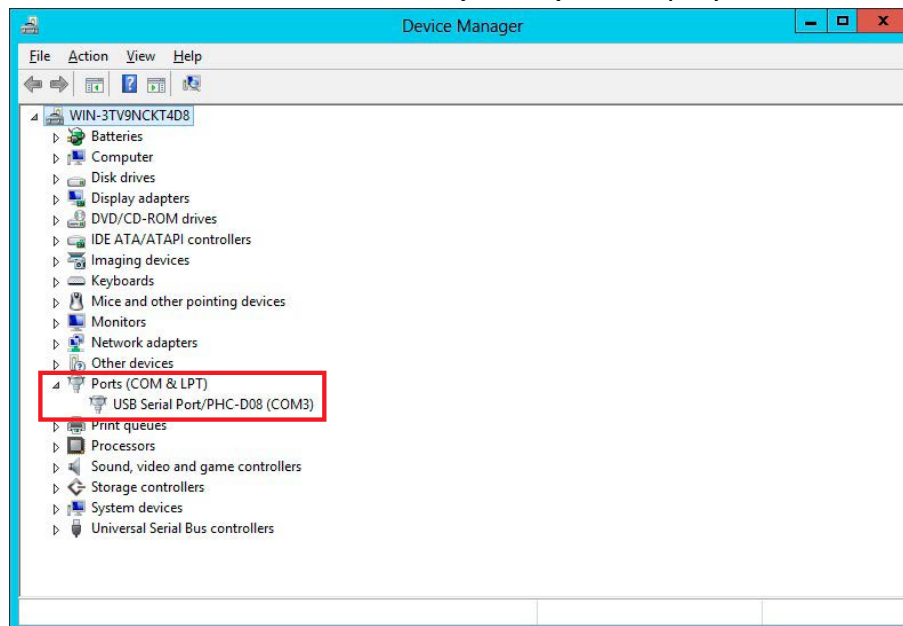

* Make sure the connected product model is displayed after the "USB Serial Port/" prefix.

4. Right-click on the "USB Serial Port/*****" and click "Uninstall" to delete.

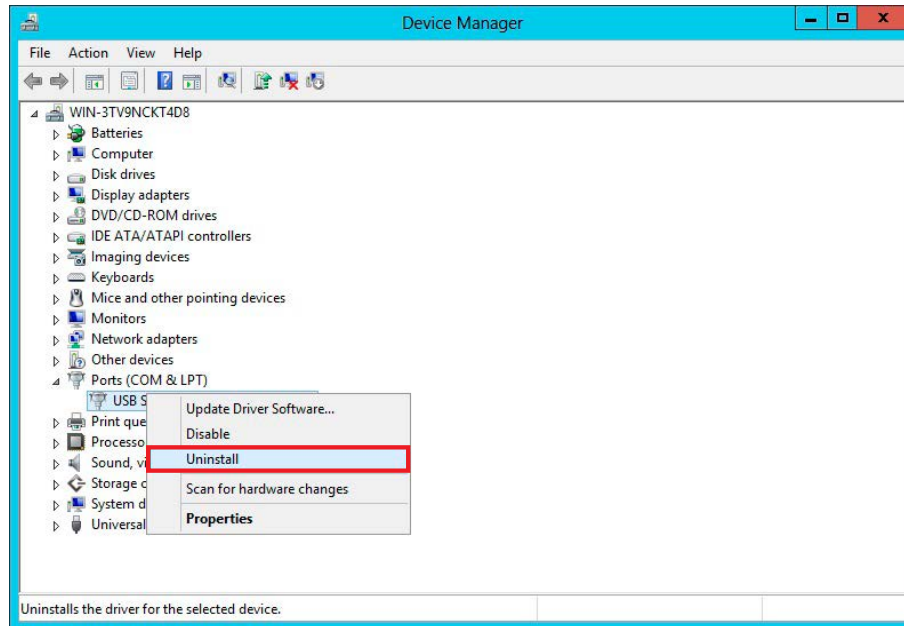

5. Put a check in the box for "Delete the driver software for this device", then click "OK" to continue.

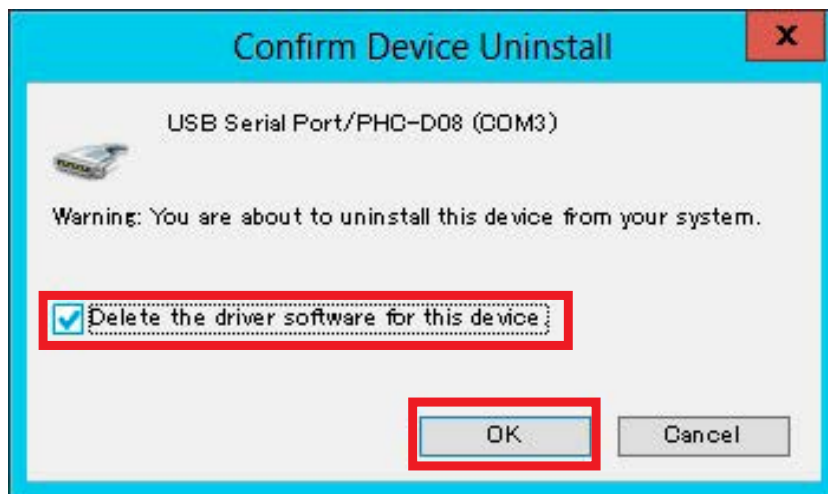

Driver Uninstallation is completed.

PATLITE Corporation

G2E

International Division

4-4-25, Hommachi, Chuo-ku, Osaka-shi, Osaka 541-0053 Japan TEL. +81-6-7711-8953

PATLITE (U.S.A.) Corporation ■ <http://www.patlite.com/>

PATLITE Europe GmbH ※Germany ■ <http://www.patlite.eu/>

PATLITE (SINGAPORE) PTE LTD ■ <http://www.patlite.com/>

PATLITE (CHINA) Corporation ■ <http://www.patlite.cn/>

PATLITE KOREA CO., LTD. ■ <http://www.patlite.co.kr/>

PATLITE TAIWAN CO., LTD. ■ <http://www.patlite.tw/>

<http://www.patlite.com/>

Interface Converter **PHE-3FB2-RYG**

User's Manual

For Models

PHE-3FB2-RYG

PHE-3FB2N-RYG

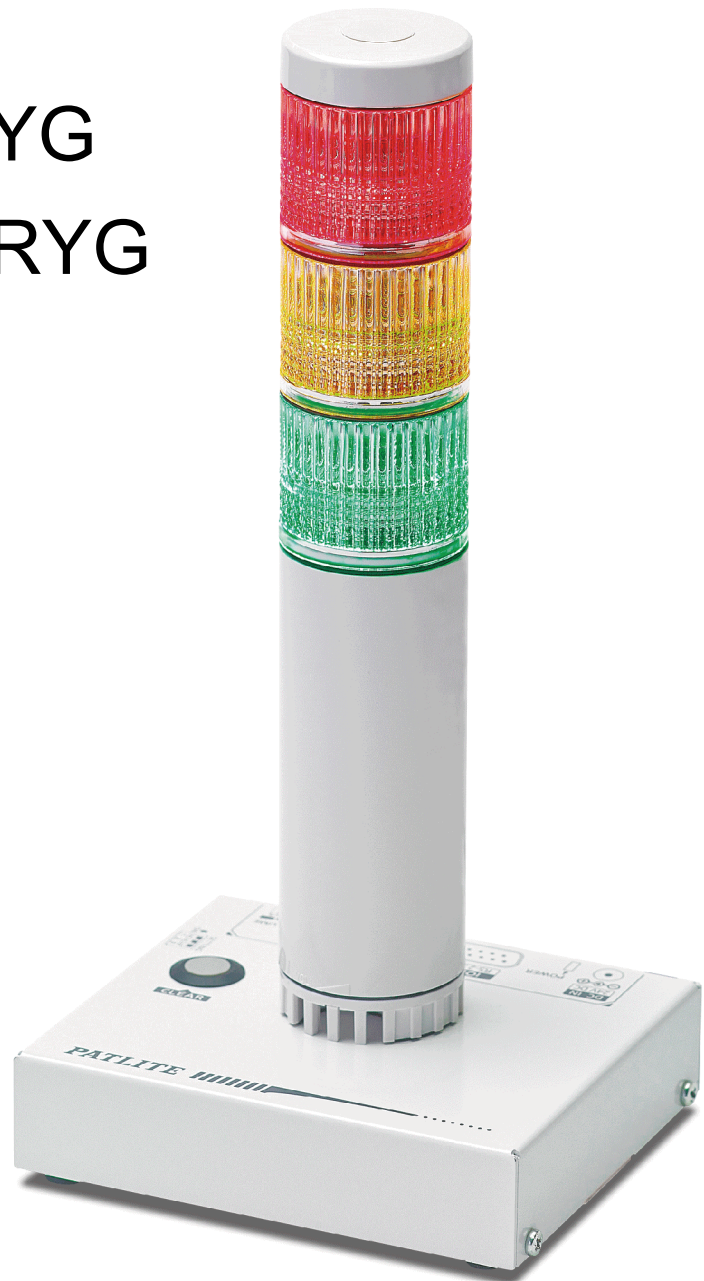

Table of Contents

Introduction	3
Notice	3
FCC Compliance	3
Product Checklist	3
For safe application, observe the following:	4
Cautionary Notes	4
1. Part Names and Dimensions	5
1.1. Model Number Configuration	5
1.2. Part Names	5
1.2.1. Main Unit	5
1.2.2. AC Adaptor	5
1.3. Outer Dimensional Drawing	6
1.3.1. Main Unit	6
1.3.2. AC Adaptor	6
2. Product Installation	7
2.1. Rubber Feet Installation	7
2.2. RS-232C Port Wiring	8
2.3. USB Port Wiring	9
2.4. "Set" Switch	10
2.5. Volume Switch	10
2.6. "Clear" Switch	11
2.7. Power Activation	11
3. Communication Specifications	12
3.1. Communication Set Up	12
3.2. Normal Operation Mode	12
3.2.1. Frame Format	12
3.2.2. Command Explanation	13
3.3. Flash/Alarm Patterns	20
3.3.1. LED Pattern	20
3.3.2. Buzzer Pattern	20
3.4. PHU Compatibility Mode	21
3.4.1. 3.3.1 Frame Format	21
4. Specifications	22
5. Maintenance and Inspection	23
6. Replacement Parts	24
7. Troubleshooting	25

Introduction

Thank you for purchasing the PATLITE “PHE-3FB2-RYG” (henceforth, written as “this product”) Interface Converter. Before installation and use, read this manual (henceforth, written as “this book”) and follow the cautions and guidelines presented. In addition, store this manual for future reference when performing maintenance, repairs or inspections. When performing maintenance and repairs, etc., be sure to reread this book. After reading this book, if there are any questions regarding this product, contact your PATLITE Sales Representative from the contact list indicated at the end of this book.

Notice

- ▶ The copyrights of this book is owned by the PATLITE Company, Inc. (henceforth, referred to as “our company”). Any reproduction, duplication, alteration, or extracting portions of this book, etc., without written permission from our company is forbidden.
- ▶ Specifications, the design, and other contents written in this book may be changed for improvements without prior notice and may result in differences from the actual product purchased.
- ▶ This product meets severe quality control and inspection requirements prior to shipment, but if some failure or defect is found, please contact the place of purchase, or your PATLITE Sales Representative (indicated on the last page) to solve the issue.
- ▶ Please understand that our company does not take any responsibility for damage and other disadvantages this product (software is included) has caused due to the customer using this product outside its designed application, such as for home, office and industrial use, high security applications such as medical or systems related to human life, directly or indirectly, or from claims from any third parties. Please understand prior to use that no responsibility is taken at our company for damages or other disadvantages, due to customers using this product beyond the scope of its general application, or from any claims from third parties. When using this product for applications in which equipment of higher reliability than the general application demands, such as a computer system, etc., use suitable safety design countermeasures against system failure, etc.
- ▶ Please understand that our company does not take any responsibility for damage and other disadvantages this product (software is included) has caused due to the customer using this product, or any claims from third parties.
- ▶ The AC Adaptor included does not conform to the EN standards, therefore, does not shows the CE Markings.
- ▶ This product, and the AC Adaptor included, contains no contents of controlled substances which exceeds the threshold of the RoHS Directive.

FCC Compliance

This equipment has been tested and found to comply with the limits for a Class A digital device, pursuant to Part 15 of the FCC Rules. These limits are designed to provide reasonable protection against harmful interference when the equipment is operated in a commercial environment. This equipment generates, uses and can radiate radio frequency energy and, if not installed and used in accordance with the instruction manual, may cause harmful interference to radio communications. Operation of this equipment in a residential area is likely to cause harmful interference in which case the user will be required to correct the interference at his own expense.





Product Checklist

The following items are contained with this product.

- PHE-3FB2-RYG Main Unit (1 Body)
- Installation Manual (1 Sheet)
- Product Assurance Provisions (1 Sheet)
- Rubber Feet (4 Pieces)
- AC Adaptor (1 Unit) (PHE-3FB2-RYG Model Only).



For safe application, observe the following:



The following symbols classifies the following into different categories and explains the level of harm inflicted if the cautions are disregarded.

 Warning	Indicates an imminently dangerous condition: failure to follow the instructions may lead to death or serious injury.
 Caution	Indicates a potentially dangerous condition: failure to follow the instructions may lead to slight injury or property damage.
 Prohibited	This symbol indicates "Prohibited", which should not be carried out by any means.
 Enforced	This symbol indicates "Enforced", which should be observed and carried out by all means.
	Notice regarding supplementary information or convenient explanation is indicated.

Cautionary Notes

Prior to installation, read all notes and use this product correctly.

 Warning	
 Prohibited	<ul style="list-style-type: none"> Do not disassemble or alter this product. Failure to comply may result in fire, electric shock, or failure. Do not touch the electric socket with wet hands. Failure to comply will result in electric shock. The power supply rating for the Adaptor is AC 100-240V. Do not allow the voltage to exceed the specified voltage tolerance. Failure to comply will result in internal circuitry damage or fire. After mounting this product on the machine, do not remove the cover, or hook anything onto the product, or use the product as a step when climbing onto the machinery. Failure to comply may result in falling off the machinery or product damage may occur. Do not insert or pull out the DC plug while power for the AC adapter is plugged in. Possible electric shock or damage may occur.
 Enforced	<ul style="list-style-type: none"> When plugging into the power receptacle, be sure to check there is no dust accumulation on the plug, and insert it completely into the power receptacle. By allowing dust to adhere, it can result in fire or failure from short-circuiting. Since dust can accumulate after a long time, along with moisture, because it can cause the dust to become conductive, in order to prevent the phenomenon of ignition from dust accumulation, it is best to periodically wipe the transformer and socket terminal with a damp cloth. By allowing dust to adhere, it can result in fire or failure from short-circuiting. When installing, wiring, or replacing parts, be sure to turn off the power first to prevent electric shock. When an unusual odor, sound or smoke comes out of the product, immediately disconnect the power, then contact your nearest PATLITE Sales Representative.

 Caution	
 Enforced	<ul style="list-style-type: none"> Place this product on a level surface, such as a desk, etc. When installing it in high places, such as on top of a shelf, please use the rubber feet provided as an accessory for the bottom of the body to prevent it from falling.
 Prohibited	<ul style="list-style-type: none"> Do not expose this product to high temperatures, such as near a fire, nor use it in humid places. Moreover, do not use this machine in locations where corrosive or combustible gas is present. If foreign substances, such as water, medicine; or metals, such as copper or low carbon steel wire, fall into this product, please do not use it. Possible cause of failure may occur. Do not disassemble (including Signal Tower Module recombination) or attempt to repair this product by any means. Failure to comply will result in equipment damage or fire. Do not bend the power supply cables or signal wires recklessly. Failure to comply will result in possible malfunction due to disconnection. Do not install or run wiring near, or where equipment (such as solenoids, etc.) generate strong electric or magnetic fields, or near any power lines. Failure to comply may result in malfunction due to inductive noise. Do not place any part of this product (Body, AC Adaptor, Rubber Feet) where infants can reach it. If it is swallowed accidentally, it could be detrimental. If it is suspected of being swallowed, please consult an emergency medical center immediately.

1. Part Names and Dimensions

1.1. Model Number Configuration

PHE-3FB2  -RYG

 AC Adaptor
 Blank: AC Adaptor Included
 N: AC Adaptor Not Included

1.2. Part Names

1.2.1. Main Unit

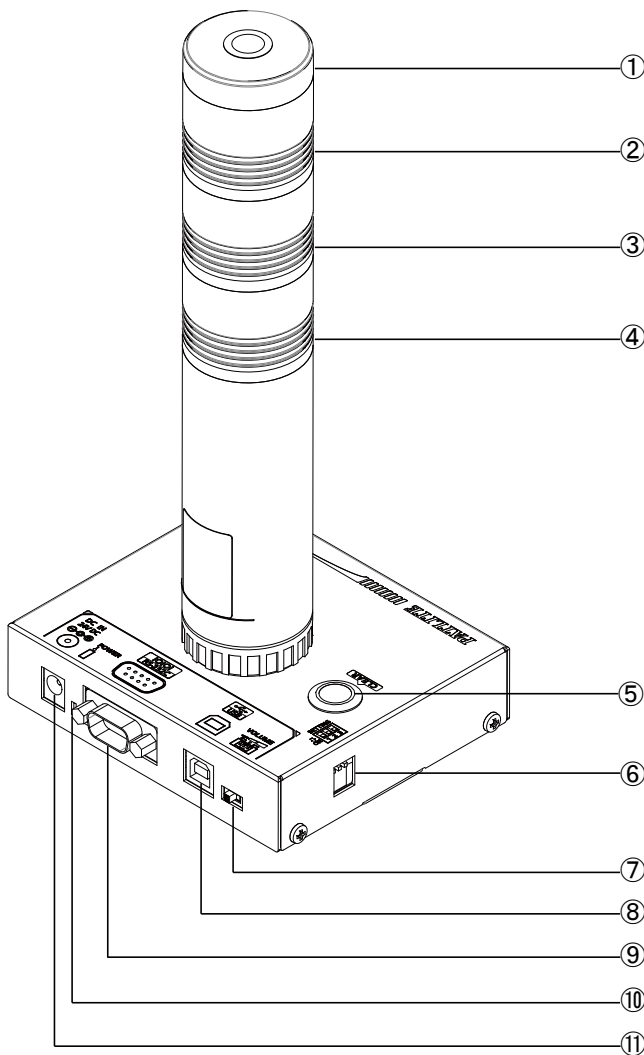

Number	Name
1	Head Cover
2	Red Unit
3	Amber Unit
4	Green Unit
5	"Clear" Switch
6	"Set" Switch
7	Volume Switch
8	USB Port (Type-B)
9	RS-232C Port (D-sub 9 pin male)
10	Power LED
11	DC Jack

1.2.2. AC Adaptor

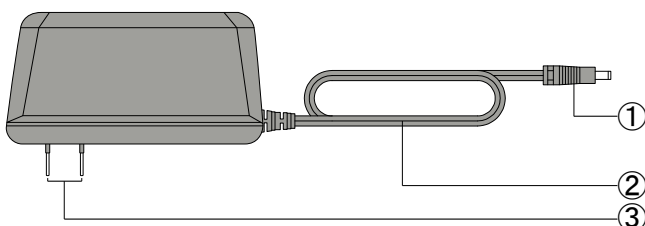

Number	Name
1	DC Plug
2	Power Supply Cable
3	Outlet Plug

1.3. Outer Dimensional Drawing

1.3.1. Main Unit

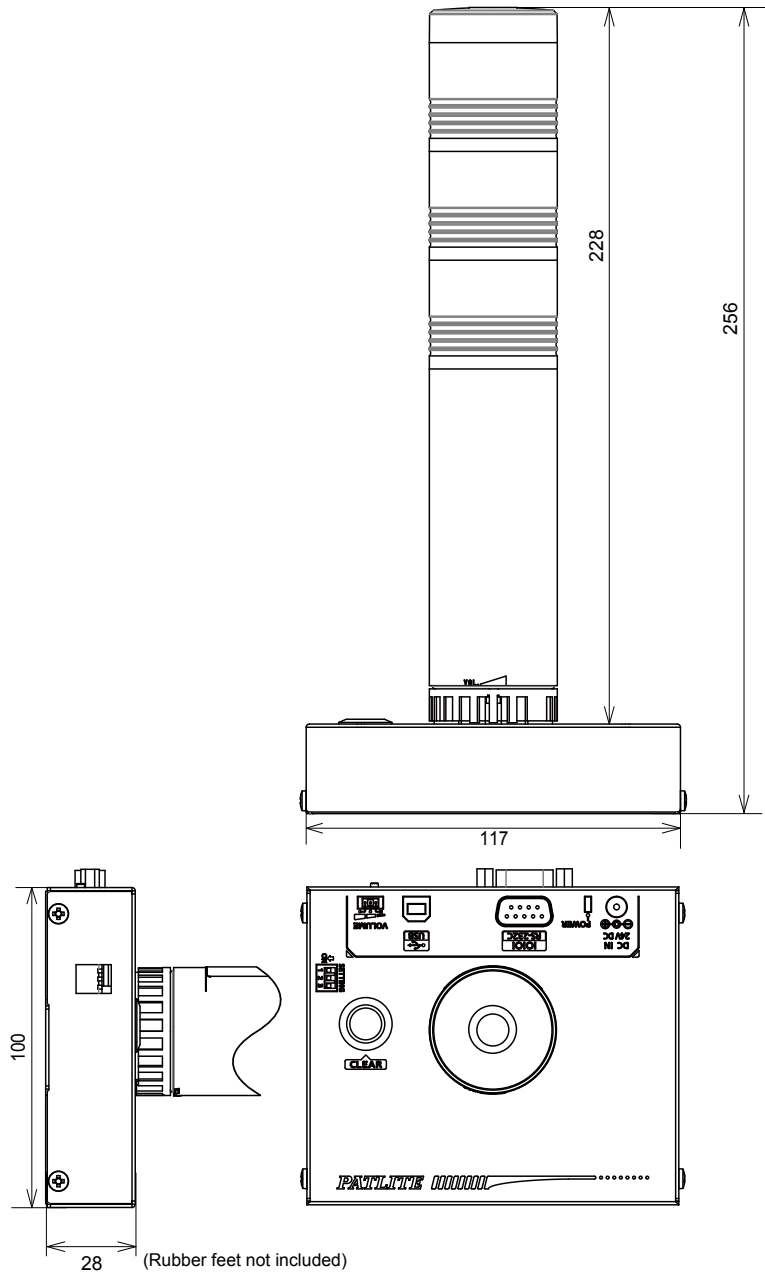

(Unit: mm)

1.3.2. AC Adaptor

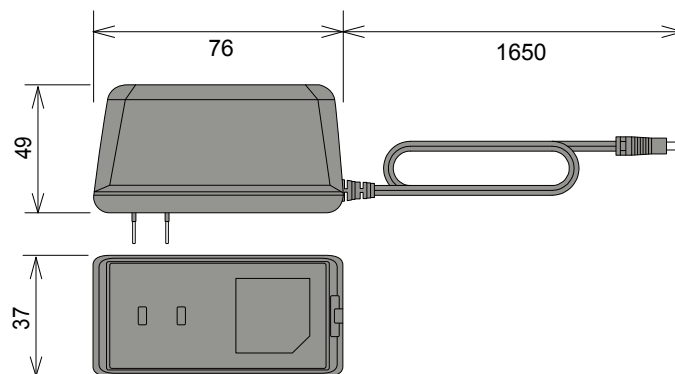

(Unit: mm)

2. Product Installation

⚠ Caution	
⊘ Prohibited	<ul style="list-style-type: none">• This product is designed for indoor use. Use this product in a location where it is not exposed to rain and water. Exposure to rain and water may result in failure and electric shock.• Install this product where the surface is stable and level. If this product is installed in an unstable location or on an incline, the product may fall, resulting in damage.• When installing this product, avoid installing it in the following places:<ul style="list-style-type: none">■ Where it's exposed to direct sunlight■ Where high temperatures are present, such as near fire, or in a humid place■ Where drastic temperature and humidity changes are present■ Where it's exposed to an environment with poor ventilation■ Where it's exposed to vibrations exceeding the specifications■ Where it's exposed to corrosive gas■ Where it's exposed to a salty air environment■ Where it's exposed to dust, iron powder, etc.■ Where it's exposed to high concentrations of chemicals or oil mist■ Where it's exposed to rain, or other types of wet environments

2

2.1. Rubber Feet Installation

Prior to the installation of this product, attach the enclosed rubber feet (four pieces) to the bottom surface of this product.

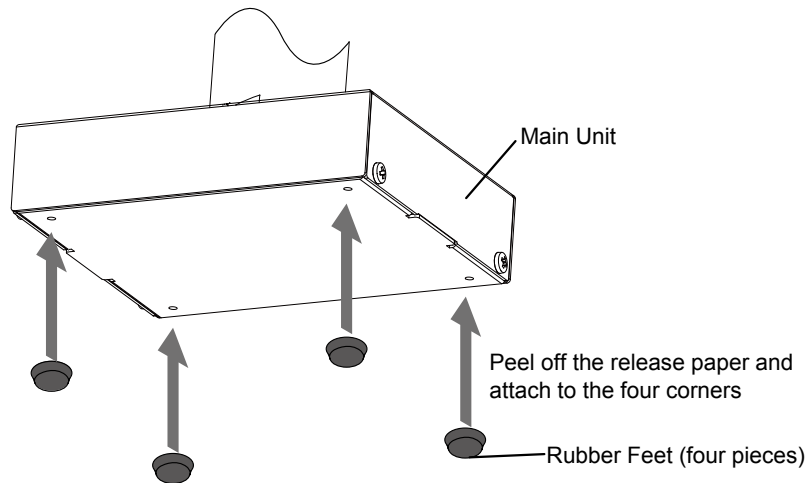

2.2. RS-232C Port Wiring

By connecting the RS-232C (male) of this product to an RS-232C port of a PC with a D-sub 9 pin female-to-female type cable with a straight wire connection, this product can be controlled via RS-232C transmission.

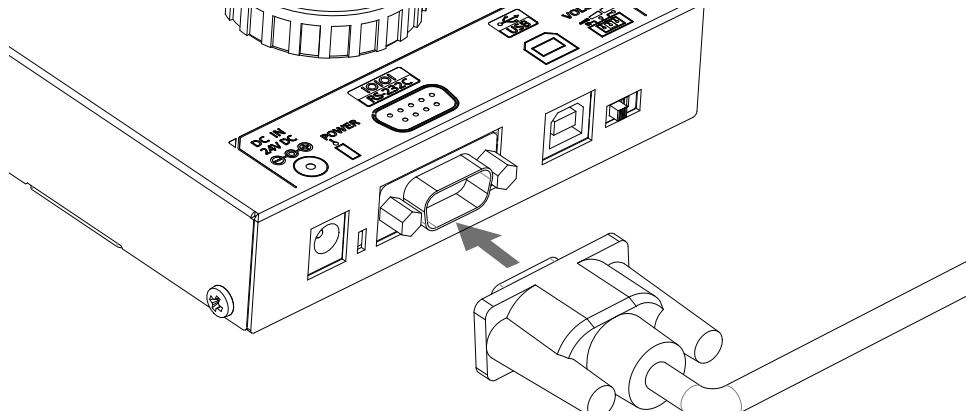

*The RS-232C cable is not included. Please purchase it separately.

Connect the cables with the connection pin numbers listed below. The pin numbers not showing will not affect the operation of this product.

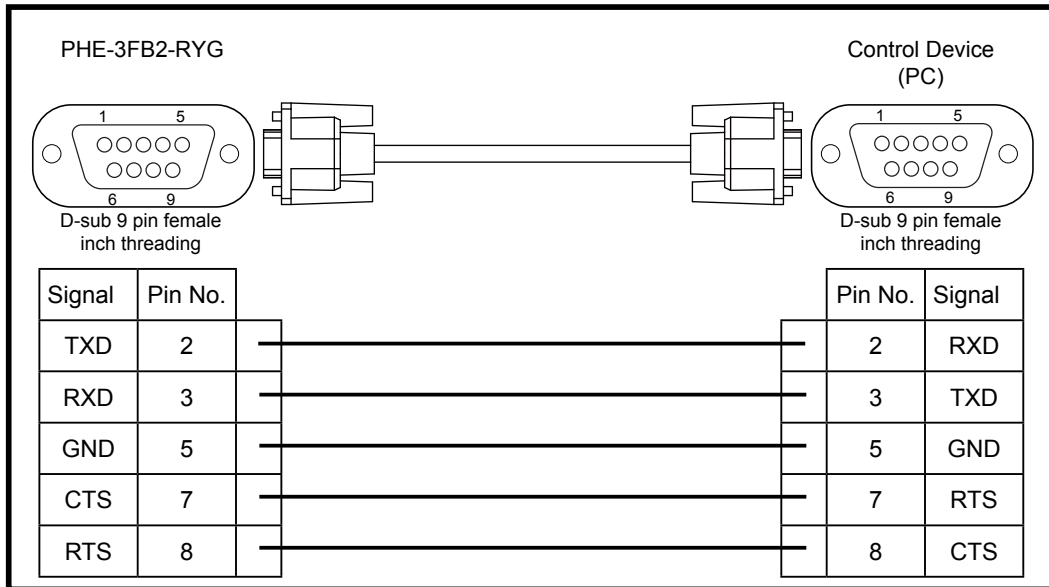

⚠ Caution

- Use a straight RS-232C cable when connecting to the connection devices (PC). This product may malfunction and cause failure to the Main Unit and other connected devices if they are used together with other devices.
- Do not bundle the RS-232C cable with the power supply cord when they are being used. Doing so may result in malfunction from noise.
- Do not connect the RS-232C cable and USB cable simultaneously. Doing so may result in malfunction.
- Do not pull out or insert the RS-232C cable while the power supply is turned on.

2.3. USB Port Wiring

This product can be controlled by connecting the USB (Type B) port from the main unit to the USB port of a PC. Since this product conforms to USB Bus Power, it can be used without an AC adapter.

This product requires installation of a specialized driver for the PC before being connected to a PC via the USB. Go to our PATLITE homepage (<http://www.patlite.com>) to download the installer.

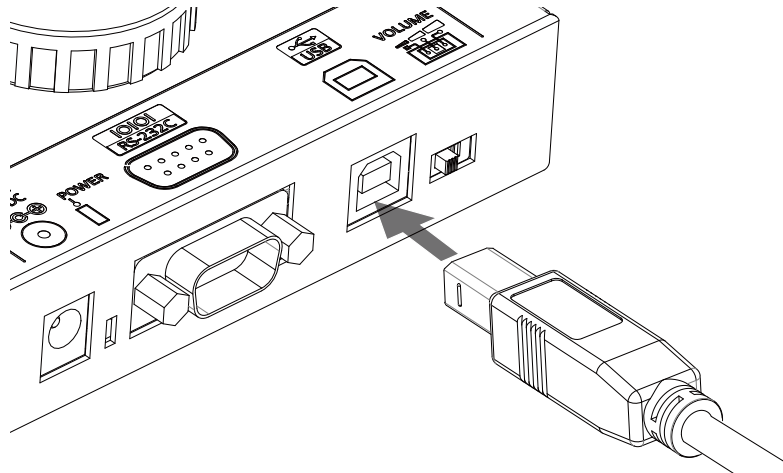

*The USB cable is not included. Please purchase it separately.



Caution

- Use a straight USB cable when connecting to the connection devices (PC). This product may malfunction and cause failure to the Main Unit and other connected devices if they are used together with other devices.
- Do not bundle the USB cable with the power supply cord when they are being used. Doing so may result in malfunction from noise.
- Do not connect the RS-232C cable and USB cable simultaneously. Doing so may result in malfunction.
- Do not insert or pull out the USB cable while power from the AC adapter is on.
- Depending on the power capability of the Main Unit or personal computer, and the USB port, operation may become unstable. In that case, use an AC Adaptor.
- Use this product by connecting it directly, do not use a USB hub. Failure to do so may cause unstable operation.
- It is recommended to use a USB cable with a length of 2m or less. A cable longer than 2m may cause unstable operation due to noise from the surrounding environment.

MEMO

- When installing exclusive drivers for compatible Operating Systems, etc., refer to the instructions attached to the drivers.

2.4. "Set" Switch

The operation mode of this product can be changed by changing the "Set" switch located on the side of this product, before power activation.

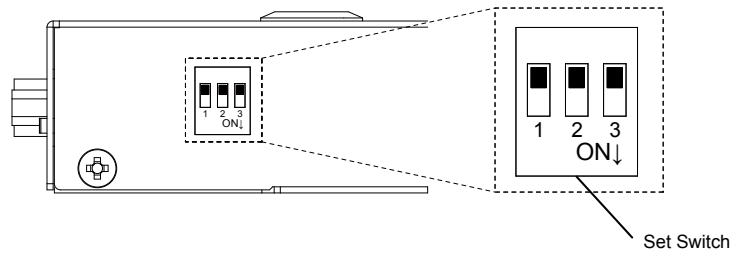

The operation modes available are as follows:

Operation Mode	Set Switch			Function
	1	2	3	
Normal Operation Mode	OFF	OFF	OFF	Operation by commands of "3.2. Normal Operation Mode"
PHU Compatible Mode	OFF	OFF	ON	Operation by commands of "3.2. Normal Operation Mode"
Firmware Update Mode	ON	OFF	OFF	Updating firmware for this product

MEMO

- For instructions on updating the firmware, download the instructions from Patlite's home page and check the manual.

Caution

- During normal operation mode and firmware update mode operation, even if it sends commands during the PHU compatibility mode, don't operate it. After changing Modes with the Set Switch, re-switch on the power source before transmitting.
- During PHU compatibility mode, or firmware update mode operation, even if it sends the command in normal operation mode, don't operate it. After changing Modes with the Set Switch, re-switch on the power source before transmitting.

2.5. Volume Switch

It is possible to adjust the volume by moving the "Volume" Switch located on the back from left to right, with the far left in the "OFF" position.

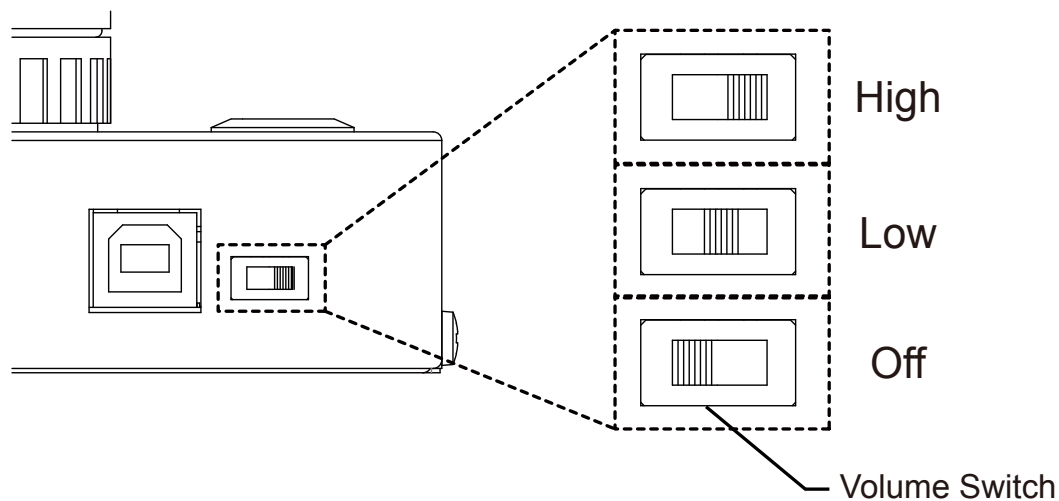

MEMO

- If the volume is set at "OFF", the buzzer sound is not audible.

2.6. "Clear" Switch

All output terminals for this product can be turned "OFF" by pushing down on the "Clear" switch.

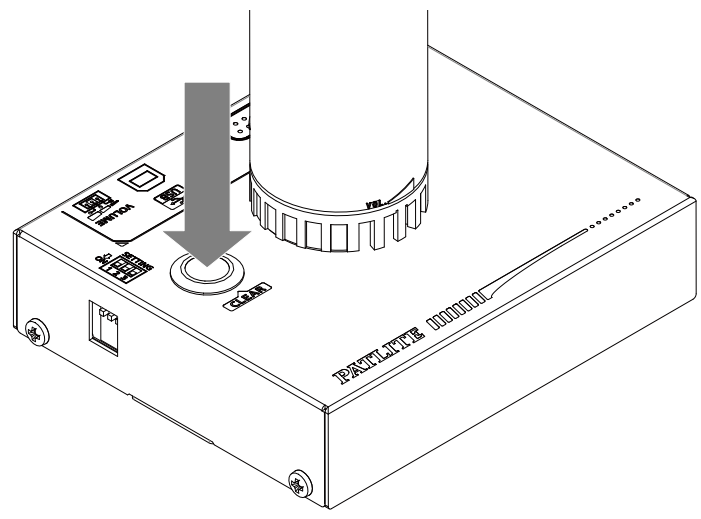

2.7. Power Activation

Two options for power activation are available for this product, using the AC adaptor or USB bus power. Select among the power sources below that match your environment and turn on the power.

1. When using an AC adaptor:
 Insert DC plug into the main body of this product, and insert the AC adaptor into an outlet. When power is switched on, the power LED will light up.
2. When using USB Bus Power
 Insert the USB cable into main body of this products and insert the top of the USB cable into the PC which has compatible bus power. When power is switched on, the power LED will light up.

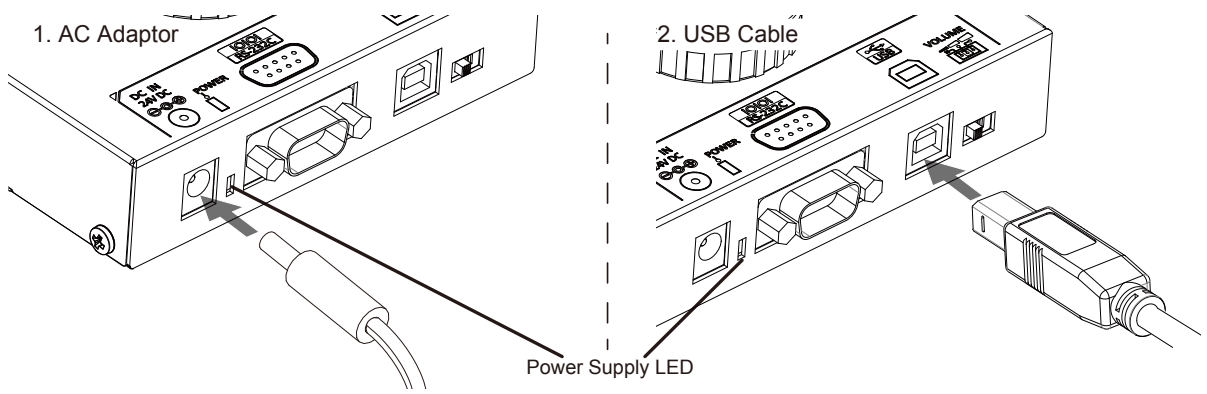

<p>Warning</p>	<ul style="list-style-type: none"> • Do not disconnect or re-insert the DC plug while the AC Adaptor is on. Possible electrical shock or damage may occur. • When plugging the AC Adaptor into the power receptacle, be sure to check there is no dust accumulation on the plug, and be sure to insert it into the power receptacle completely. By allowing dust to adhere to the AC Adaptor plug, it can result in fire or failure from short-circuiting. • Do not touch the electric socket with wet hands. Failure to comply will result in electric shock.
----------------	---

<p>Caution</p>	<ul style="list-style-type: none"> • Depending on the capacity of the power supply for the PC or Main Unit USB port, operation may become unstable. Use an AC Adaptor if this occurs. • Use this product by connecting it directly, do not use a USB hub. Failure to do so may cause unstable operation.
----------------	--

3. Communication Specifications

3.1. Communication Set Up

Configure the appropriate operation mode for the commands that shall be sent from the PC to communicate with this product.

	Normal Operation Mode	PHU Compatible Mode
Communication Specification	RS-232C Compliant	
Baud Rate	9600bps	19200bps
Data Length	8 bit	
Stop Bit	1 bit	
Parity	None	
Flow Control	None	

3.2. Normal Operation Mode

Normal Operation Mode can control the Signal Tower and buzzer by sending ASCII data to this product in the following format.

3.2.1. Frame Format

Below, the transmit data format is explained. Because the Identification Number (hereafter, referred to as "ID") is recorded inside this product, the ID will not change, even if the power is turned off.

		Header	ID *	Command	Data	End Code
Send Data	ASCII Code [HEX Code]	@ [40H]	?? [3FH 3FH]	Refer to the command list	By command	! [21H]
Byte Count		1Byte	2Byte	1Byte	0~6Byte	1Byte

* ID (default setting= "??") set up for this product is as follows.

Refer to "3.2.2.3. <Set ID for this product>" on how to change the ID. Normally using "??" allows execution of commands irrespective of the main unit ID.

3.2.1.1. <Comand List>

The list of commands and functions which can be used is shown in the table below.

Command		Number of Data Bytes	Function
ASCII	Hex		
1	[31H]	2 Bytes	Turns on a specified Signal Tower light and sounds the buzzer
0	[30H]	2 Bytes	Turns off a specified Signal Tower light and stops the buzzer
?	[3FH]	2 Bytes	Changes the ID.
S	[53H]	6 Bytes	Controls the Signal Tower and buzzer operation.
G	[47H]	0 Bytes	Acquires the Signal Tower and buzzer conditions
C	[43H]	0 Bytes	Switches off the Signal Tower lights and buzzer.
M	[4DH]	0 Bytes	Acquires information from the Signal Tower

MEMO

- A "1" and "0" Command has compatibility with the PC Controlled Signal Tower PHE-3FBE1.
- Since the "S" command can control Flashing Pattern 2, as well as Buzzer Patterns 3 and 4, it is recommended to use the "S" command for controlling those operations for this product. When using the "S" command, do not use the "1" or "0" commands.
- After sending a control command to the Main Unit as per it's specifications, if the control commands are sent without waiting for the reply data from the Main Unit, it will not operate normally (Which is how it is supposed to operate when a NAK reply is not received).

3.2.2. Command Explanation

The following are examples on how to send each of the commands from the command list table.

3.2.2.1. <Turn on specified Signal Tower light and sound buzzer>

Sending ASCII data in the following form will control the specified Signal Tower light to turn on and sound the buzzer. The bit in the data section is specified as "0", of which the Signal Tower and buzzer will maintain their condition, and the bit in the data section specified as "1" will turn off the Signal Tower lights and sound the buzzer.

[Transmission Example]

In this example, the Signal Tower red shall flash, amber will light up, and buzzer pattern 2 shall sound.

- Send Data

Header	ID		Command	Data			End code
@ [40H]	? [3FH]	? [3FH]	1 [30H]	3 [33H]	2 [32H]	!	[21H]

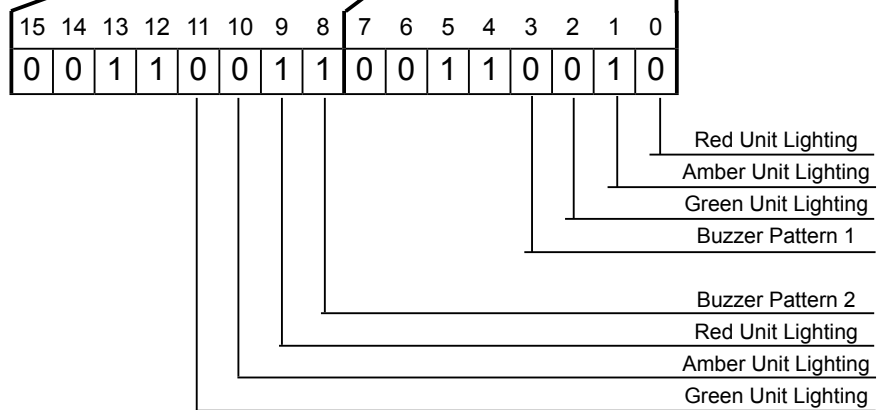

- Reply Data

Normal Response

Data
ACK [06H]

Response Error

Data
NAK [15H]

The following are conditions in which will get a NAK reply, and the error contents are as follows.

Transmission Condition	Error Contents
Command Error	When commands other than a command from the list are specified
Data error	When the data outside of 0[30H] - ?[3FH], is specified
Data size error	When the number of bytes in the send data is different
Timeout	When the reply interval for every byte exceeds 5 seconds after receiving a header

*Do not transmit the following command, before this product transmits reply data. It may not operate normally.

MEMO

- If Lighting and Flashing are used simultaneously by the same unit, Lighting will take priority.
- If Buzzer pattern 1 and Buzzer pattern 2 are used simultaneously, Buzzer pattern 1 will take priority.

3.2.2.2. <Turn off specified Signal Tower light and stop buzzer sound>

Sending ASCII data in the following form will control the specified Signal Tower light to turn off and stop the buzzer. The bit in the data section is specified as "0", of which the Signal Tower and buzzer will maintain their condition, and the bit in the data section specified as "1" will turn off the Signal Tower lights and stop the buzzer.

[Transmission Example]

In this example, the Signal Tower red flashing and amber lighting shall be turned off, and buzzer pattern 2 shall stop.

- Send Data

Header	ID		Command	Data			End code
@ [40H]	? [3FH]	? [3FH]	0 [30H]	5 [35H]	1 [31H]	! [21H]	

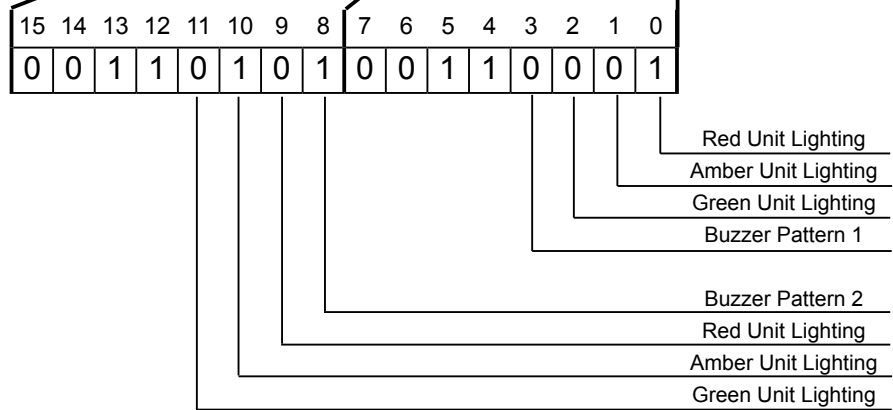

- Reply Data
Normal Response

Data
ACK [06H]

- Response Error

Data
NAK [15H]

The following are conditions in which will get a NAK reply, and the error contents are as follows.

Transmission Condition	Error Contents
Command Error	When commands other than a command from the list are specified
Data error	When the data outside of 0[30H] - ?[3FH], is specified
Data size error	When the number of bytes in the send data is different
Timeout	When the reply interval for every byte exceeds 5 seconds after receiving a header

*Do not transmit the following command, before this product transmits reply data. It may not operate normally.

3.2.2.3. <Set ID for this product>

Sending ASCII data in the following form will change the ID of this product. Two ASCII bytes are designated in the data section to change to a new ID. The configuration range for each byte of data in the data section can set up from 0 [30H] to ? [3FH].

[Transmission Example]

In this example, the ID set at 56 [35H 36H] shall be changed to 21 [32H 31H].

- Send Data

Header	ID		Command	Data		End Code
@ [40H]	5 [35H]	6 [36H]	? [3FH]	2 [32H]	1 [31H]	! [21H]

- Reply Data

Normal Response

Data
ACK [06H]

Response Error

Data
NAK [15H]

The following are conditions in which will get a NAK reply, and the error contents are as follows.

Transmission Condition	Error Contents
Command Error	When commands other than a command from the list are specified
Data error	When the data outside of 0[30H] - ?[3FH], is specified
Data size error	When the number of bytes in the send data is different
Timeout	When the reply interval for every byte exceeds 5 seconds after receiving a header

*Do not transmit the following command, before this product transmits reply data. It may not operate normally.

3.2.2.4. <Control Signal Tower and buzzer operation>

Sending ASCII data in the following form will transmit data to control the Signal Tower and buzzer.

[Transmission Example]

In this example, the red is turned on, amber maintains its condition and green is turned off on the specified Signal Tower, and the buzzer sounds Pattern 4.

- Send Data

Header	ID		Command	Data						End Code
				Signal Tower *1			Unused *2		Buzzer *3	
				Red	Amber	Green				
@ [40H]	? [3FH]	? [3FH]	S [53H]	1 [31H]	9 [39H]	0 [30H]	-	-	4 [34H]	! [21H]

*1 List of specified data for Signal Tower

Command		Function
ASCII	Hex	
0	[30H]	Turns Signal Tower Lighting off
1	[31H]	Turns Signal Tower Lighting on
2	[32H]	Turns on Signal Tower Flashing Pattern 1
3	[33H]	Turns on Signal Tower Flashing Pattern 2
9	[39H]	No Change in Condition

*2 This value is undefined.

*3 List of specified data for buzzer

Command		Function
ASCII	Hex	
0	[30H]	Mutes the Buzzer
1	[31H]	Turns on Buzzer Pattern 1
2	[32H]	Turns on Buzzer Pattern 2
3	[33H]	Turns on Buzzer Pattern 3
4	[34H]	Turns on Buzzer Pattern 4
9	[39H]	No Change in Condition

- Reply Data

Normal Response

Data
ACK [06H]

Response Error

Data
NAK [15H]

The following are conditions in which will get a NAK reply, and the error contents are as follows.

Transmission Condition	Error Contents
Command Error	When commands other than a command from the list are specified
Data error	When the data outside of 0[30H] - ?[3FH], is specified
Data size error	When the number of bytes in the send data is different
Timeout	When the reply interval for every byte exceeds 5 seconds after receiving a header

*Do not transmit the following command, before this product transmits reply data. It may not operate normally.

3.2.2.5. <Acquire Signal Tower and buzzer conditions>

When ASCII data is transmitted in the following format, the reply data will return with a 6 byte ASCII value to indicate the Signal Tower and buzzer status.

[Transmission Example]

In this example, the acquisition data obtained indicate the condition in which red is “off”, amber is “on” and green is flashing pattern 2 on the signal tower, with the buzzer sounding pattern 3.

- Send Data

Header	ID		Command	End Code
@ [40H]	? [3FH]	? [3FH]	G [47H]	! [21H]

- Reply Data

Normal Response

Signal Tower *1			Unused		Buzzer *2
Red	Amber	Green			
0 [30H]	1 [31H]	3 [33H]	0 [30H]	0 [30H]	3 [33H]

*1 List of reply data for Signal Tower

Command		Function
ASCII	Hex	
0	[30H]	Signal Tower Lighting is turned off
1	[31H]	Signal Tower Lighting is turned on
2	[32H]	Signal Tower Flashing Pattern 1 is turned on
3	[33H]	Signal Tower Flashing Pattern 2 is turned on
9	[39H]	No Change in Condition

*2 List of reply data for buzzer

Command		Function
ASCII	Hex	
0	[30H]	Buzzer is muted
1	[31H]	Buzzer Pattern 1 is turned on
2	[32H]	Buzzer Pattern 2 is turned on
3	[33H]	Buzzer Pattern 3 is turned on
4	[34H]	Buzzer Pattern 4 is turned on

Response Error

Data
NAK [15H]

The following are conditions in which will get a NAK reply, and the error contents are as follows.

Transmission Condition	Error Contents
Command Error	When commands other than a command from the list are specified
Data size error	When the number of bytes in the send data is different
Timeout	When the reply interval for every byte exceeds 5 seconds after receiving a header

*Do not transmit the following command, before this product transmits reply data. It may not operate normally.

3.2.2.6. <Turn off Signal Tower light and stop the buzzer>

Sending ASCII data in the following form will control the Signal Tower light to turn off and stop the buzzer.

[Transmission Example]

In this example, the Signal Tower lights are turned off and the buzzer is stopped.

- Send Data

Header	ID		Command	End Code
@ [40H]	? [3FH]	? [3FH]	C [43H]	! [21H]

- Reply Data

Normal Response

Data
ACK [06H]

Response Error

Data
NAK [15H]

The following are conditions in which will get a NAK reply, and the error contents are as follows.

Transmission Condition	Error Contents
Command Error	When commands other than a command from the list are specified
Data size error	When the number of bytes in the send data is different
Timeout	When the reply interval for every byte exceeds 5 seconds after receiving a header

*Do not transmit the following command, before this product transmits reply data. It may not operate normally.

3.2.2.7. <To obtain information on this product>

When ASCII data in the following format is sent, acquired information, such as the version, ID, switch settings and Volume switch position of this product will have a 6 byte ASCII reply.

[Transmission Example]

In this example, the reply data indicates the latest version is 1.00, ID is “??”, and the condition of all setting switches and volume is OFF.

- Send Data

Header	ID		Command	End code
@ [40H]	? [3FH]	? [3FH]	M [4DH]	! [21H]

- Reply Data

Normal Response

Product Information					
Version		ID		Set Switch	Volume *
[01H]	[00H]	? [3FH]	? [3FH]	[00H]	[00H]

7	6	5	4	3	2	1	0
0	0	0	0	0	0	0	0

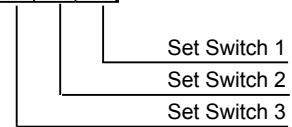

1: on

2: off

*1 List of reply data for Signal Tower		
Command		Function
ASCII	Hex	
0	[30H]	Signal Tower Lighting is turned off
1	[31H]	Signal Tower Lighting is turned on
2	[32H]	Signal Tower Flashing Pattern 1 is turned on
3	[33H]	Signal Tower Flashing Pattern 2 is turned on
9	[39H]	No Change in Conditon

Response Error

Data
NAK [15H]

The following are conditions in which will get a NAK reply, and the error contents are as follows.

Transmission Condition	Error Contents
Command Error	When commands other than a command from the list are specified
Data size error	When the number of bytes in the send data is different
Timeout	When the reply interval for every byte exceeds 5 seconds after receiving a header

*Do not transmit the following command, before this product transmits reply data. It may not operate normally.

3.3. Flash/Alarm Patterns

3.3.1. LED Pattern

Three kind of operating patterns for this product is available, such as continuous lighting, Flashing pattern 1, and Flashing pattern 2. Below is the description of the timing for the operation:

Continuous "ON"



Flashing Pattern 1 [Repetitive 800ms "ON"; 800ms "OFF"]



Flashing Pattern 2 [Repetitive 120ms "ON", 280ms "OFF", 120ms "ON", 280ms "OFF"; 1080ms "OFF"]



4

3.3.2. Buzzer Pattern

Four kind of buzzer sounds, such as; Buzzer pattern 1, Buzzer pattern 2, Buzzer pattern3, and Buzzer pattern4, are available to distinguish a variety of conditions with the use of audible and visual warnings. Below is the description of the timing for the operation:

Buzzer Pattern 1 [Repetitive 40ms "ON"; 40ms "OFF"]



Buzzer Pattern 2 [Repetitive 800ms "ON"; 800ms "OFF"]



Buzzer Pattern 3 [Repetitive 240ms "ON", 160ms "OFF", 240ms "ON"; 960ms "OFF"]



Buzzer Pattern 4 [Continuous "ON"]



4. Specifications

SPECIFICATIONS		
[General Specifications]		
Model	PHE-3FB2-RYG	AC Adaptor included
	PHE-3FB2N-RYG	AC Adaptor not included
Rated Voltage	24V DC (Main Unit) 5V DC (USB Bus Power)	
AC Adaptor	Input: 100V - 240V AC (50/60Hz) Output: 24V DC	
Operating Voltage Range	90V - 264V AC (With AC Adaptor used)	
Rated Current Consumption	Standby	36mA (at 24VDC) 27mA (at 5VDC)
	Maximum	146mA (at 24VDC) 240mA (at 5VDC)
Rated Power Consumption	Standby	1.2W (at 100VAC) 0.9W (at 24VDC) 0.2W (at 5VDC)
	Maximum	4.1W (at 100VAC) 3.5W (at 24VDC) 1.2W (at 5VDC)
Operating Ambient Temperature	0°C - +40°C	
Operating Ambient Humidity Range	20% - 85%RH (No dew or condensation accumulation)	
Storage Ambient Temperature Range	-10°C - +60°C	
Storage Ambient Humidity Range	20% - 85%RH (No dew or condensation accumulation)	
Mounting Location	Indoor Only	
Mounting Direction	Upright	
Protection Rating	IP 20	
Insulation Resistance	More than 10MΩ at 500VDC between the terminals and the chassis	
Withstand Voltage	1500VAC for 1min between terminals (10mA or less) and chassis without breaking insulation	
Mass (Tolerance ±10%)	580g	
Outer Dimensions	Refer to the Dimensional Drawing	
Compliance Standards	RoHS Directive (EN 50581) EMC Directive (EN 55022 (Class A), EN 55024) FCC Part 15 Subpart B Class A UL/CSA 60950-1 (For PHE-3FB2N-RYG) PSE Compliant AC Adaptor (Main Unit Exempt)	
Interface	USB Port	USB 2.0 Conformity (supports Bus Power) Standard B Type (Female)
	Serial Port	RS-232C Conformity D-Sub 9 pin (male)
Communication Method	USB Port	CDC (Communication Device Class) Protocol
	Serial Port	Asynchronous System (Baud Rate 9600bps, No Parity, Stop Bit=1bit, Data Length:8bit, No Flow Control)
Signal Tower		Clear Lens Type
	Red	1000mcd or more (AC Adaptor)
	Amber	1000mcd or more (AC Adaptor)
	Green	800mcd or more (AC Adaptor)
Alarm Sound Pressure	More than 80 dB (at 1m in front of Main Unit)	
Control Unit	Clear Switch, Set up DIP Switch, Volume Control Slide-switch	
Accessories	AC Adaptor (PHE-3FB2-RYG Only), Installation Manual, Rubber Feet	
Option Parts	None	
Remarks		
[Functional Specifications]		
Signal Tower Control	The Signal Tower is controlled in correspondence to control commands	
Buzzer Control	The buzzer is controlled in correspondence to control commands	
Identification (ID) Number Setup	The ID setup is controlled in correspondence to control commands, and is recorded in memory	
"Clear" Switch	Switches off the Signal Tower lights and buzzer.	
Power Source Display	The operating status is shown by a power LED	
Buzzer Alarm Sound	A slide switch selection of 3 levels (High, Low, Off) to adjust the buzzer sound	
Operating Mode Switch	Operating Modes are changed with a DIP switch	
	Normal Operation Mode	This mode is used for communication protocol with the PHE.
	PHU Compatibility Mode	This mode is used to simulate the communications protocol for the PHU.
	Firmware Rewriting Mode	This mode is used when updating this product's firmware

5. Maintenance and Inspection

Cleaning

- When cleaning, be sure to disconnect the power before doing so.
- The cleaning of this product should be with a soft cloth and a neutral detergent (such as dish soap), diluted with water and should be wiped lightly. Since it is easy to crack the surface of the product when wiping with too much strength, be careful.
- Do not wipe this product with volatile chemicals, or chemically treated dustcloths containing benzene, thinner, etc.
- Do not wipe with a cloth containing too much moisture. If moisture gets inside the product, it can cause short circuiting, electric shock, or fire.
- Periodically remove dust from the electric socket to prevent a fire hazard. By allowing dust to adhere to the power supply contacts, it can be the result of fire or failure from short-circuiting.

Inspection

- Refer to the list below and check the following contents when inspecting this product.

Inspection Checklist		Inspection Contents
Supplied Power Source	Power Supply Voltage Tolerance	Tolerable Voltage Range should be from AC100 to 240V
Surrounding Environment	Ambient Temperature	Operating Temperature Range should be from 0 to 40oC
	Ambient Humidity	Operating Humidity Range should be 20 to 80% RH
	Presence of Dust	No dust should be accumulated

6. Replacement Parts

The following list indicates the available replacement part for this product. When inquiring, ask the store where you purchased this product for ordering information on replacement part pricing and availability.

Model Name	Part Name
PHE-3FB2-RYG	Rubber Feet
	AC Adaptor
	Red Unit
	Amber Unit
	Green Unit
	Head Cover
	Center Screw
	Cover Seal

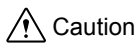

Caution

- Only use the replacement parts when making a repair where there is a part failure.
- Do not attempt to do a Signal Tower color array recombination, nor add extensions by any means.
- Prior to exchanging, be sure to extract all cables and check that the power source is OFF.

7. Troubleshooting

Problem	Check the following
Power supply LED is not illuminated.	Make sure that the AC adapter is connected properly. Refer to "2.7. Power Activation"
	Make sure that the USB cable is connected properly. Refer to "2.3. USB Port Wiring" In case the USB hub is used, there is a possibility that the power supply from the PC is not sufficient. Refer to "2.7. Power Activation"
The Signal Tower is dark	Use the AC adapter. The Signal Tower may be dark in operation with USB bus power. Refer to "2.7. Power Activation"
The Signal Tower is not turned on	Make sure that setting switch is in Normal Operation Mode or PHU Compatibility Mode. Refer to "2.4. "Set" Switch"
	Send the following command after receipt of responding data from the main body. Refer to "3.2. Normal Operation Mode"
	Make sure that the communication configuration is configured properly. Refer to "3.2. Normal Operation Mode"
	Make sure that the AC adapter is connected properly. Refer to "2.7. Power Activation"
	Make sure that a straight cable is used. Refer to "2.3. USB Port Wiring"
The buzzer does not sound	Make sure that the volume switch is not OFF. Refer to "2.5. Volume Switch"

PATLITE

PATLITE Corporation

G2E

International Division

4-4-25, Hommachi, Chuo-ku, Osaka-shi, Osaka 541-0053 Japan TEL. +81-6-7711-8953

PATLITE (U.S.A.) Corporation ■ <http://www.patlite.com/>

PATLITE Europe GmbH *Germany ■ <http://www.patlite.eu/>

PATLITE (SINGAPORE) PTE LTD ■ <http://www.patlite.com/>

PATLITE (CHINA) Corporation ■ <http://www.patlite.cn/>

PATLITE KOREA CO., LTD. ■ <http://www.patlite.co.kr/>

PATLITE TAIWAN CO., LTD. ■ <http://www.patlite.tw/>

<http://www.patlite.com/>

T95100239 C

'16.5 WEB

Interface Converter Installation Manual [MODEL : PHE-3FB2-RYG]

Thank you very much for purchasing our Patlite products. Read this installation manual thoroughly before using this product to ensure correct use, and store this manual for future reference. Read this manual again in case of maintenance, inspection or repair.

This manual is meant to briefly describe precautions, wiring, and other installation related instructions. For more detailed instructions, please download them from our website from the appropriate product page.

<http://www.patlite.com/>

Please refer to this product's page on our website to check on version upgrades and other updated product information.

Safety Precautions

The following symbols classifies the following into different categories and explains the level of harm inflicted if the cautions are disregarded.

- Warning** Indicates an imminently dangerous condition: failure to follow the instructions may lead to death or serious injury.
- Caution** Indicates a potentially dangerous condition: failure to follow the instructions may lead to slight injury or property damage.
- Note** Indicates helpful information to be used prior to using this product.

1. For safe application, observe the following:

- Warning**
 - Do not modify or disassemble the product. Doing so may result in fire, electric shock, and failure.
 - Do not leave or use this product while the LED unit and head cover are detached or broken. Doing so may result in electric shock.
 - Be sure to use this product within the operating voltage range. Using the product outside the operating voltage range may result in product damage or fire.
- Caution**
 - Clean the LED unit and head cover with a soft cloth dampened with water or glass cleaner. The use of thinner, benzene, gasoline, or oil may result in corrosion on the surface, discoloration, and deformation.
 - Do not use the product in an environment where corrosive gas is present. Doing so may result in failure.
 - This product is designed for indoor use. Use this product in a location where it is not exposed to rain and water.

It is not the responsibility of Patlite for any failure or damage from natural disasters, mishandling and disassembly, or modifications that deviate from the cautions and warnings provided in this manual. It is recommended to avoid the use of this product for purposes other than described in this manual.

2. Model Number Configuration

PHE - 3FB2 - RYG

■ AC Adaptor
Blank : AC Adaptor included
N : AC Adaptor not included

3. Part Names

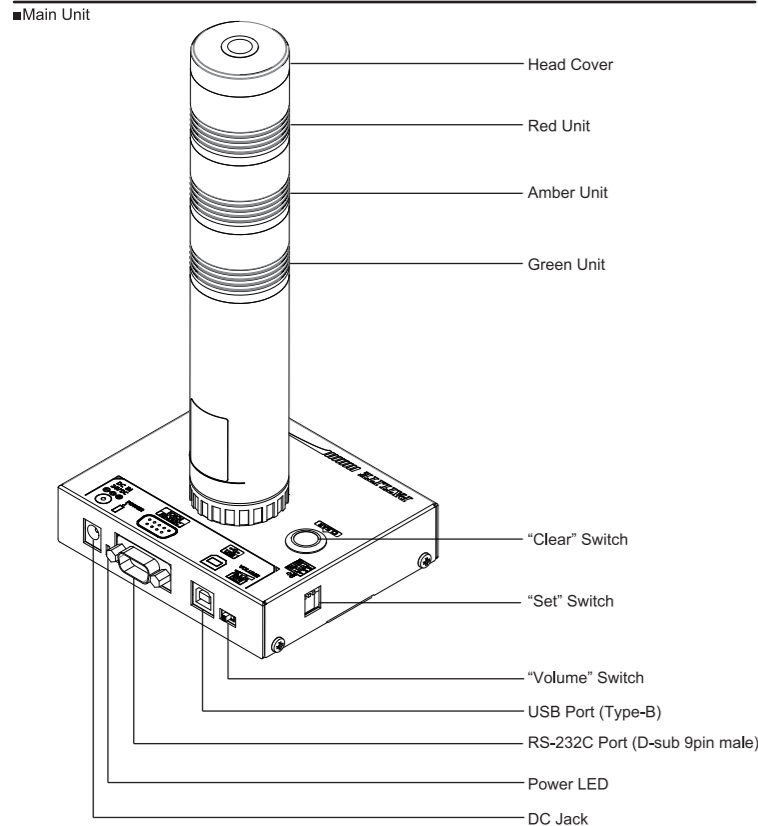

Accessories

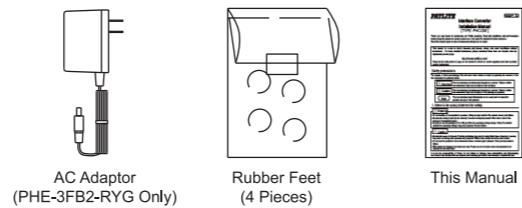

Note

- Please purchase an RS-232C and USB cable separately, since they are not included.

4. Product Installation

Prior to the installation of this product, attach the enclosed rubber feet (4 pieces) to the bottom surface of this product.

Caution

- This product is designed for indoor use. Use this product in a location where it is not exposed to rain and water. Exposure to rain and water may result in failure and electric shock.
- Install this product where the surface is stable and level. If this product is installed in an unstable location or on an incline, the product may fall, resulting in damage.

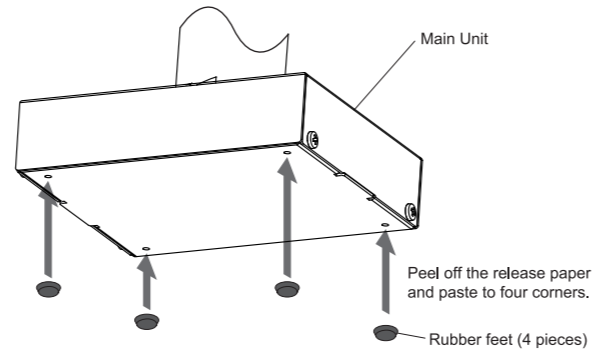

- Install this product so that the Buzzer Aperture faces in the forward direction.

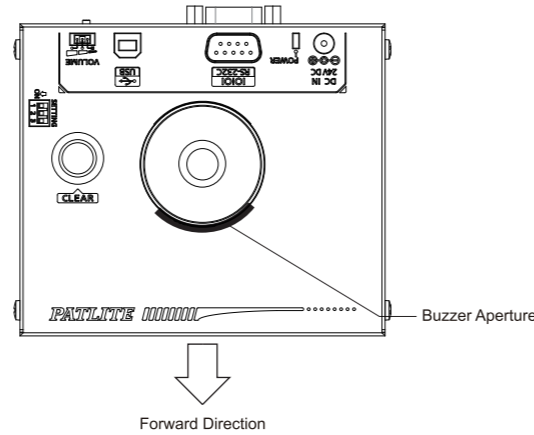

Note

- When installing this product, pay attention to the mounting direction since the buzzer sound level is at it's maximum towards the front.

5. Wiring

Caution

- Use a straight RS-232C cable when connecting to the connection devices (PC). This product may malfunction and cause failure to the Main Unit and other connected devices if they are used together with other devices.
- Do not bundle the RS-232C and the USB cable with power supply cords when being used. Failure to comply may result in malfunction from power line noise.
- Do not connect the RS-232C and USB cables simultaneously. Failure to comply may result in malfunction.

5.1. RS-232C Port Wiring

By connecting the RS-232C (male) of this product and RS-232C port of a PC with a D-sub 9 pin female-to-female type cable with straight wire connection, this product can be controlled via RS-232C transmission.

Caution

- Do not connect the RS-232C and USB cables simultaneously. Failure to comply may result in malfunction.
- Do not pull out or insert the RS-232C cable while the power supply is turned on.

*The RS-232C cable is not included. Please purchase it separately.

5.2. USB Port Wiring

This product can be controlled via USB transmission by connecting a USB (Type B) cable from the Main Unit to the USB port of a PC. Since this product conforms to USB Bus Power, it can be used without using an AC Adaptor. *The USB cable is not included. Please purchase it separately.

Note

- This product requires installation of a specialized driver for the PC before being connected to a PC via the USB. Go to our PATLITE homepage to download the installer.

Caution

- Depending on the feeding power capability of the Main Unit or the USB port of the personal computer, operation may become unstable. Use an AC Adaptor if this condition occurs.
- Use this product by connecting the USB cable directly, without the use of a USB hub. Failure to comply may cause unstable operation.
- It is recommended to use a USB cable with a length of 2m or less. A cable longer than 2m may cause unstable operation due to noise from the surrounding environment.
- Do not connect the USB and RS-232C cables simultaneously. Failure to comply may result in malfunction.
- Do not insert or pull out the USB cable while the power supply is turned on.

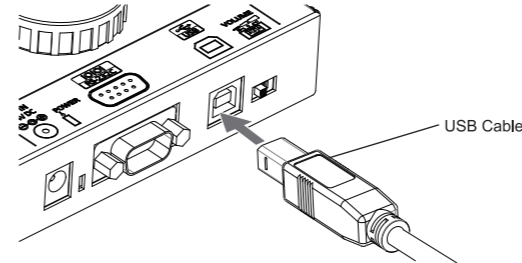

6. Operating Method

Turn on the power supply after confirming that all the "Set" switches are off for "Normal Operation" mode. The specification contents, protocols, and transmission commands are described in the instruction manual. Use this product after downloading the instruction manual from the product web page and reading it thoroughly. It is necessary to create your own software, since the control software for this product is not included. The specialized driver needs to be installed if this product is to be control via USB.

7. "Volume" Switch

It is possible to adjust the volume by moving the "Volume" Switch located on the back from left to right, with the far left in the "OFF" position.

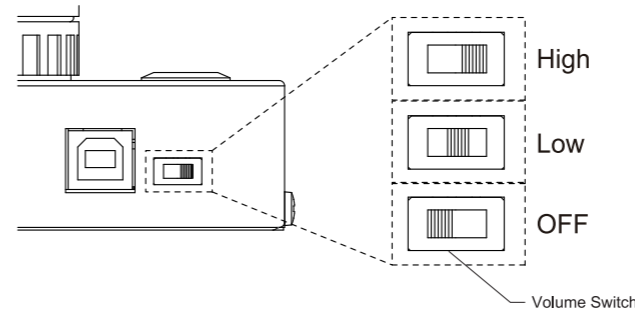

Note

- If the volume is set at "OFF", the buzzer sound is not audible.

8. Specifications

Items	Specifications	
Rated Voltage	Main Unit	24VDC (Main Unit) 5VDC (USB Bus Power)
	AC Adaptor	24VDC (Main Unit) 5VDC (USB Bus Power)
Operating Voltage Range	90VAC - 264VAC (AC Adaptor)	
Rated Power Consumption	Standby	1.2W (100VAC)
	Maximum	4.1W (100VAC)
Operating Ambient Temperature	0°C to +40°C	
Operating Ambient Humidity	20% to 85% RH (No Dew or Condensation)	
Storage Ambient Temperature	-10°C to +60°C	
Storage Ambient Humidity	20% to 85% RH (No Dew or Condensation)	
Mounting Location and Direction	Indoor, Upright	
Protection Rating	IP20	
Insulation Resistance	More than 10MΩ at 500VDC between the terminals and the chassis	
Withstand Voltage	1500 VAC applied for 1min (10mA or less) between terminals and chassis without breaking insulation	
Mass	370g (±10%)	
Interface	USB Port	USB 2.0 Conformity (Bus Powered) Standard Type B (Female)
	Serial Port	RS-232C Conformity D-Sub 9 pin (Male)
	USB Port	CDC (Communication Device Class) protocol
Communication method	Serial Port	Asynchronous (Baud Rate: 9600bit/s, No Parity, Stop bit= 1bit, Data Length: 8bit, No flow control)
	Lens Specification	Clear Lens
Luminous Intensity	Red	1000mcd or more (AC Adaptor)
	Amber	1000mcd or more (AC Adaptor)
	Green	810mcd or more (AC Adaptor)
Sound Pressure Level	80dB or more (1m from the buzzer)	
Accessories	AC Adaptor (PHE-3FB2-RYG Only), Installation Manual, Rubber Feet	

8.1. Outer Dimensional Drawing

Main Unit

(Unit: mm)

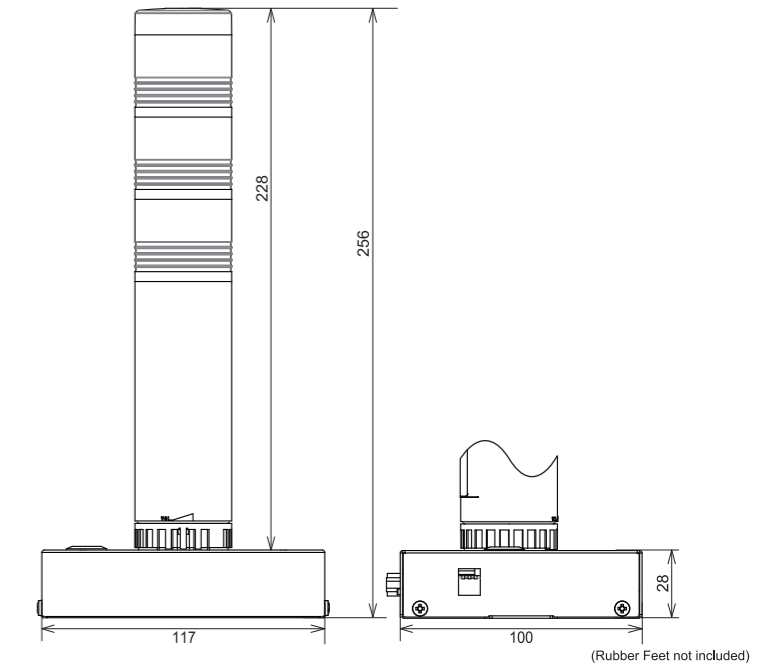

AC Adaptor

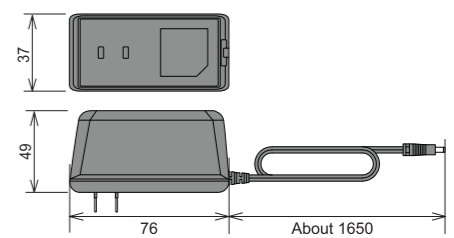

PATLITE Corporation G2E

International Division
4-4-25, Hommachi, Chuo-ku, Osaka-shi, Osaka 541-0053 Japan TEL. +81-6-7711-8953

PATLITE (U.S.A.) Corporation <http://www.patlite.com/>
PATLITE Europe GmbH *Germany <http://www.patlite.eu/>
PATLITE (SINGAPORE) PTE LTD <http://www.patlite.com/>
PATLITE (CHINA) Corporation <http://www.patlite.cn/>
PATLITE KOREA CO., LTD. <http://www.patlite.co.kr/>
PATLITE TAIWAN CO., LTD. <http://www.patlite.tw/>

<http://www.patlite.com/>