



Multipole connectors

20

22

THE TRADITION OF INNOVATION SINCE 1945

ILME designs and manufactures complete solutions for industrial connections.

Headquartered in Milan and with subsidiaries in the key countries driving the progress of automation, ILME is an industry leader in the main world markets.

People are vital to success and growth at ILME, sharing a passion for innovation, utmost responsibility and participation.

The Company is committed to developing technology in the areas that most impact the future of the industries it serves: original solutions and safe wiring, research on the most suitable materials, rapid turnaround and readily available services while striving for energy saving and environmental safeguard.

COMMITMENT TO INDUSTRY

Technological innovation is the main pillar of ILME competitiveness.

In the electrical connection sector of industrial automation, characterized by the need for top performance and reliability, ILME is an acknowledged leader with its own patents, and a global benchmark supplier of major companies worldwide.

ILME offers a fully integrated range of high-quality products and services for every type of connection to suit any application requirements.



AUTOMATION



RAILWAY



ENERGY



MARINE



FOOD
& BEVERAGE



AGRONOMY



OUTDOOR



TRANSPORT



LIGHT
& SOUND



PLASTICS



CHEMICAL



AIRPORT

IMPORTANT NOTES

- 1 ILME designs and manufactures complete solutions for Heavy Duty electrical power connections.
The connector (although offered to the user as a variety of elements, usually inserts and enclosures, to allow the selection of the ideal combination) has been **designed as a complete connector** and tested to be compliant with the essential safety requirements of the EU Low Voltage Directive 2014/35/EU and in particular the EN 61984 standard. The design of this “whole” system guarantees that every allowed combination of inserts, enclosures and accessories cannot result as improper.

- 2 The products in this catalogue alone cannot guarantee the best functionality upon installation, as this depends also on their correct “**putting into service**” which must be performed in compliance with the applicable system safety standards and according to the “rule of the art”. Therefore the effectiveness of the installation of the connector depends on the choices of the end user who must also take into account the following safety requirements.

- 3 Connectors must **not be connected or disconnected when live or under load**.

- 4 After wiring the inserts it is necessary to **verify the continuity of the protective earth connections**.

- 5 The **correct coupling of the inserts** is guaranteed only if they are installed (with the four fixing screws supplied *) inside the corresponding enclosures or onto compatible accessories in this catalogue. ILME S.p.A. is not responsible for any different application.

- 6 Wiring of **screw-type terminal connections** must be carried out applying the correct tightening torque in order to avoid false contacts or damage to the conductor, the screw or the terminal.

- 7 **Crimping tools** and **crimp contacts** used should preferably be supplied by the same manufacturer to avoid difficulties with the insertion and retention or damaging of the contacts themselves.

- 8 Correct wiring of **spring-clamp connection inserts** is guaranteed only when the correct screwdriver indicated in the specific catalogue, or possibly on the insert, is used **.

- 9 Avoid forcing the contacts during **connection and disconnection**. Connectors must be coupled and uncoupled in the axial direction with respect to the contacts, without bending and pulling the attached conductor bundles or cables.

- 10 Installation of two **inserts side by side**, in enclosures with two bays, must respect the polarity drawing marked on the insert (or the contact side view, as shown in this catalogue) to avoid inverted coupling.

- 11 Installation of two or more identical **connectors side by side** is recommended only with the use of **coding pins** in order to avoid mismatched couplings.

- 12 In order to keep the declared **degree of protection** (IP code according to EN 60529, or Enclosure Type Rating according to ANSI/UL 50E), enclosures must be completed with cable glands and/or other accessories with at least an equal degree of protection.

- 13 Moreover, the declared **degree of protection** (IP code according to EN 60529, or Enclosure Type Rating according to ANSI/UL 50E) is guaranteed when the enclosures, complete with inserts, are coupled and locked with their locking levers (or devices).

- 14 Connector inserts and their enclosures are generally compatible with similar/equivalent products from other manufacturers, according to the last samples tested. Full compatibility cannot be guaranteed in the event of technical changes made by other manufacturers. In particular, maximum performance of IP68 enclosures (CG-MG, CGK-MGK Series) cannot be guaranteed when coupled with other manufacturers' products.

- 15 **Spare parts** are supplied in minimum quantities only with the purpose to replace damaged parts. To avoid invalidation of warranty, products should be modified or repaired only by ILME: the integrity of their functionality - e.g. their degree of protection - can no longer be guaranteed if products are modified/repared by end-users. In any case, the liability for correct choice, assembly and use is totally at charge of the installer and the end-user.

- 16 ILME S.p.A. takes no responsibility in verifying whether the components herein contained comply with any specific regulations of fields of application.

- 17 ILME cannot be held responsible for individual components in **uses other than those described in this catalogue**.
ILME cannot be held responsible for **incorrect connector selection** in relation to the environmental conditions of the application (e.g.: influence of ambient temperature, moisture, environmental pollution, etc.).

* Except one fixing screw for size “21.21” inserts, two fixing screws for size “32.13” inserts.

** Except for **SQUICH**® inserts (with spring-clamp terminals with actuator button) and **AXYR**® inserts (push-in spring terminals with actuator button) that do not require any tool to operate the terminal.

CE MARKING

As from 1st January 1997, in order to make available electrical products on the European market, the manufacturer must ensure that these bear the relevant **CE marking**, in line with the Low Voltage Directive 73/23/ EEC* (implemented in Italy as L. D. 18-10-1977 no. 791) and its modification 93/68/EEC* (implemented in Italy as L.D. 25-11-1996 no. 626/96, published in the supplement to the Gazzetta Ufficiale of 14-12-1996).

The CE marking must be visible on the product or, if this is not possible, on the packaging, the instructions for use or on the warranty certificate. It acts as a declaration by the manufacturer that the product complies with all relevant EU directives regarding its field of application.

ILME products bear the CE marking on the actual product or its packaging.

Almost all ILME products fall within the scope of the Low Voltage Directive. An EU declaration of conformity is required in order to be able to apply the CE marking. This declaration, to which the market is not directly entitled, must be made available to the controlling authorities (in Italy, the Ministry of Economic Development) at all times. In it, the manufacturer declares the technical safety standard(s) followed in the design and manufacture of the product. These standards must be, in decreasing order of preference:

- a European standard (EN prefix)
- a European harmonisation document (HD prefix)
- an international IEC standard
- a national standard
- in the absence of reference standards, the manufacturer's internal specifications guaranteeing compliance with the basic safety requirements of the directive.

Conformity with harmonised technical standards (i.e. ratified by CENELEC) also constitutes presumption of conformity with the basic safety requirements of the directives.

The CE marking of ILME products results from the declaration of conformity of the product to harmonised standards or international IEC standards.

Through the CE marking, ILME declares full compliance, not merely with the directive's basic safety requirements, but also with those international or national standards on which voluntary safety certification markings are based (e.g. IMQ and VDE). In this way, ILME intends to give the CE marking the value of self-certification in terms of safety, given the loss in legal value of voluntary certifications issued by third parties, ratified by directive 93/68/EEC*.

Notwithstanding the above, practically all ILME products still bear voluntary conformity markings.

The above mentioned EU declaration of conformity becomes null and void when the assembly of products includes one or more components not manufactured by ILME and without CE marking.

▲ The information contained in this catalogue is not binding and may be changed without notice.

* **Note:** The subsequent legal reference for the Low Voltage Directive was 2006/95/EC, as consolidation of the original Directive 73/23/EEC + Directive 93/68/EEC. On 29th March 2014, the Official Journal of the European Union published the new Low Voltage directive 2014/35/EU dd. 26th February 2014, a recast version of directive 2006/95/EC, which is in force since 20th April 2016.



UNI EN ISO 9001: 2015
Design, manufacture and distribution
of industrial electrical equipment (IAF 19)
Certificate No. 50 100 11133

Visit **ilme.com** website to discover all the main features:



Technical datasheets
to get all the information about our products.



Application pages
to focus on installation locations, field requirements and technical details.



Download Area
to find all the useful files in a click.



Get into our **Configurator** to easily find the right solution that fits your needs



search

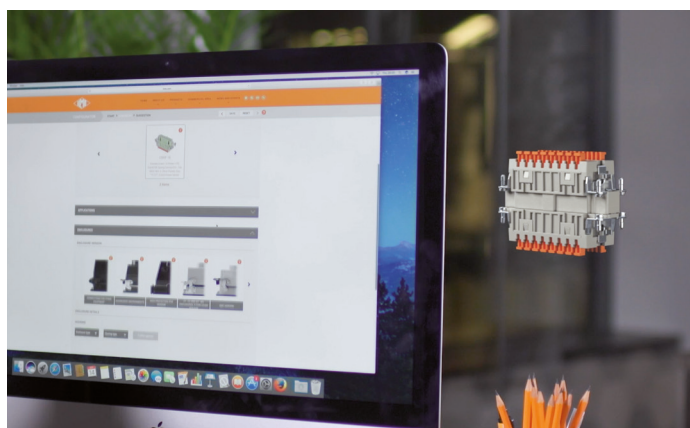

Over **50 million** connector combinations.

choose

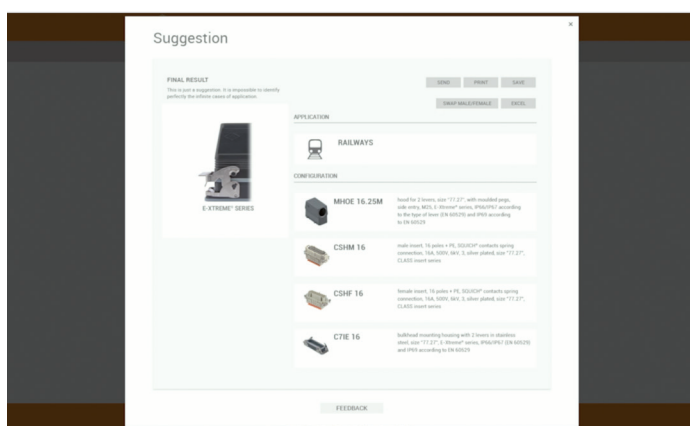

Easy selection of individual parts for key applications and recommendations for custom environmental conditions.

download



Smart suggestion to get the most suitable configuration.

HIGH-DENSITY FAST & TOOL-LESS CONNECTIONS

14



AXYR®

PRODUCT RANGE
FOR 16 A CONNECTIONS

14

AXYR® FROM INSIDE
- THE WIRING

15

AXYR® TECHNOLOGY
- ZOOM-IN AND BENEFITS

16

AXYR® PRODUCT RANGE
- FOR 16 A CONNECTIONS

17

AXYR®
CQY 05 inserts

19

CQYF 05
CQYM 05



AXYR®
CQY 08E inserts

20

CQYF 08E
CQYM 08E



AXYR® MIXO
6 poles modules

22

CX 06 CYF
CX 06 CYM



AXYR® MIXO
8 poles modules

23

CX 08 CYF
CX 08 CYM

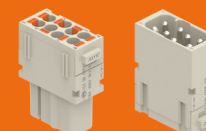

POWER FOR ENERGY STORAGE

24

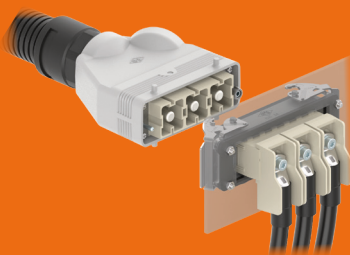

MIXO module for 90°-angled screw terminal connection

24

CX 01 YAF
CX 01 YAM

26

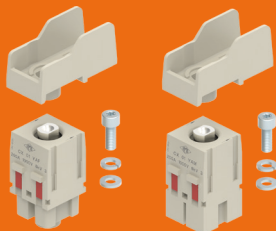

Assembly instructions

27

MIXO MODULAR SERIES

28

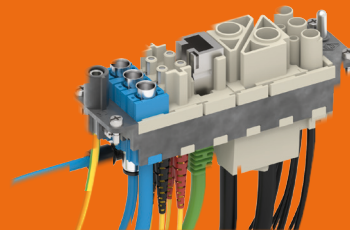

MIXO NOVELTIES

28

MIXO SERIES GENERAL OVERVIEW

30

THE COMPLETE RANGE

32

TECHNICAL CHARACTERISTICS

33

CQ 08 NEW METAL CONCEPT

34



AXYR® CQY 08E inserts

36

CQYF 08E
CQYM 08E

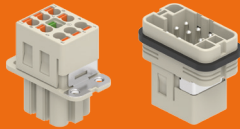

Crimp CQ 08E inserts

37

CQF 08E
CQM 08E

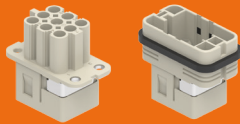

CQA/MQA 08 SIZE "32.13"

38

CQA 08 I
MQA 08 O25
MQA 08 V25

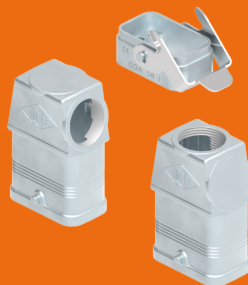

STAINLESS STEEL CORE

40



IL-BRID LOCKING LEVERS FOR STANDARD SIZE ENCLOSURES CM / ML

Technical features

42-49



THE ULTIMATE HYGIENIC EVOLUTION

50



T-TYPE HYGIENIC SERIES T-TYPE/H ENCLOSURES

Technical features

52-59

T-TYPE HYGIENIC SERIES T-TYPE/C ENCLOSURES

Technical features

60-67



HNM RANGE WIDENING

68

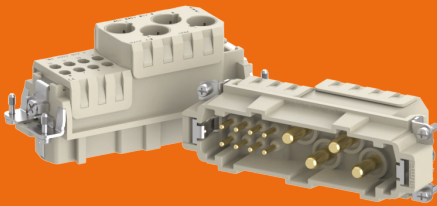

RXC Series
Combined crimp connectors

RXCF 4/2
RXCM 4/2

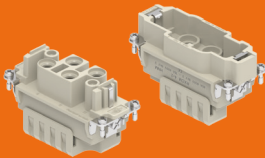

68

RXCF 4/8
RXCM 4/8

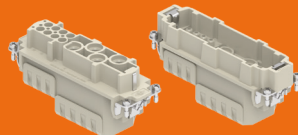

72

80 A HNM
Crimp contacts, gold plated

RX7..2D..



70, 74

16 A HNM
Crimp contacts, gold plated

RC..2D..

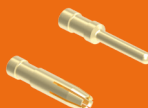

71, 75

Size "21.21" Enclosures
HNM version

76-81

Size "21.21"
crimp inserts

CQF 21
CQM 21



82

CDF 08
CDM 08



83

HNM

RQF 05
RQM 05

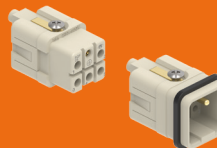

84

CQ4F 03
CQ4M 03

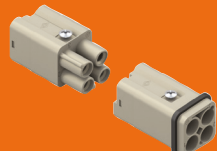

85

ACCESSORIES

86

T-TYPE Enclosures Series

86

Dust protection cover
size "44.27"

TCP 06



RX7 Series Fingerproof male crimp contacts

88

HNM Version with insulating cap

RX7M2D..P



AXYR®

HIGH-DENSITY, FAST & TOOL-LESS CONNECTIONS

PRODUCT RANGE FOR 16 A CONNECTIONS

The research of new termination technologies aims to develop a reliable and qualitatively stable connection between conductor and contact, meeting any possible application requirement in terms of current carrying-capacity and available number of poles, as much as possible independently from the skill of the operator.

Crimped connection, with its typical irreversible process, achieves the best performance and the highest possible connection density, but requires specific wiring procedures and special tools, while being also non-rewirable.

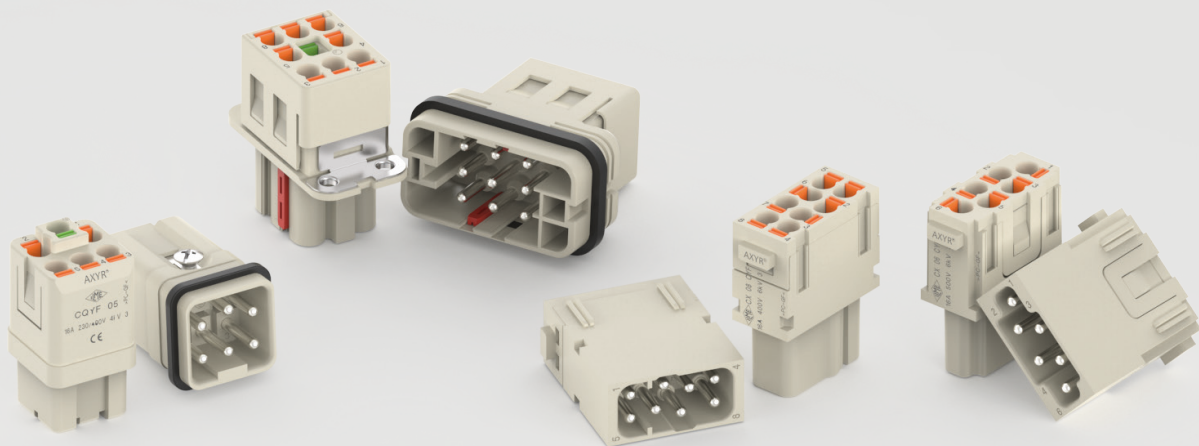

- Q **ILME AXYR® technology** offers an extremely compact **spring push-in** termination, which equals the crimp connectors in **high density**, but requires **no special crimping tool**, yet granting an optimal electrical performance. **An easy, tool-less and operator skill independent connection**, resistant to mechanical stress and vibrations, suitable for any installation requirement.
- Q **AXYR®** features a harmonic steel spring and a tiny, yet stiff, properly designed actuator button working together to allow a **simple push-in action** guaranteeing a safe wiring.
- Q Thanks to a **boxed terminal**, the wire contact pressure does not rely upon surrounding insulating parts, likely to possibly relax under heating when the connector is under current load.

- Q Solid and ferruled flexible wires, when sufficiently stiff, can be **directly inserted** into the connection terminal*; unprepared stranded wires require instead the initial opening of the spring by means of a simple flat-blade screwdriver, thanks to the actuator button.
- Q **AXYR®** technology makes the **user free to choose** the connector that best suits his needs, naturally reusable and **independent of the required wire cross-section**, compatible with the crimp connectors of the ILME product portfolio: **one size fits the whole range of cross-sectional areas** (compared to competing solution with radial spring that require two sizes).

* Cross-sectional area $\geq 0,75 \text{ mm}^2 / 18 \text{ AWG}$

AXYR® FROM INSIDE

THE WIRING



Watch our
Video



**SOLID
OR FERRUED WIRE**
(CSA* \geq 0,75 mm² / 18 AWG)



STRANDED WIRE
(all CSA)
SOLID OR FERRUED WIRE
(CSA < 0,75 mm² / 18 AWG)

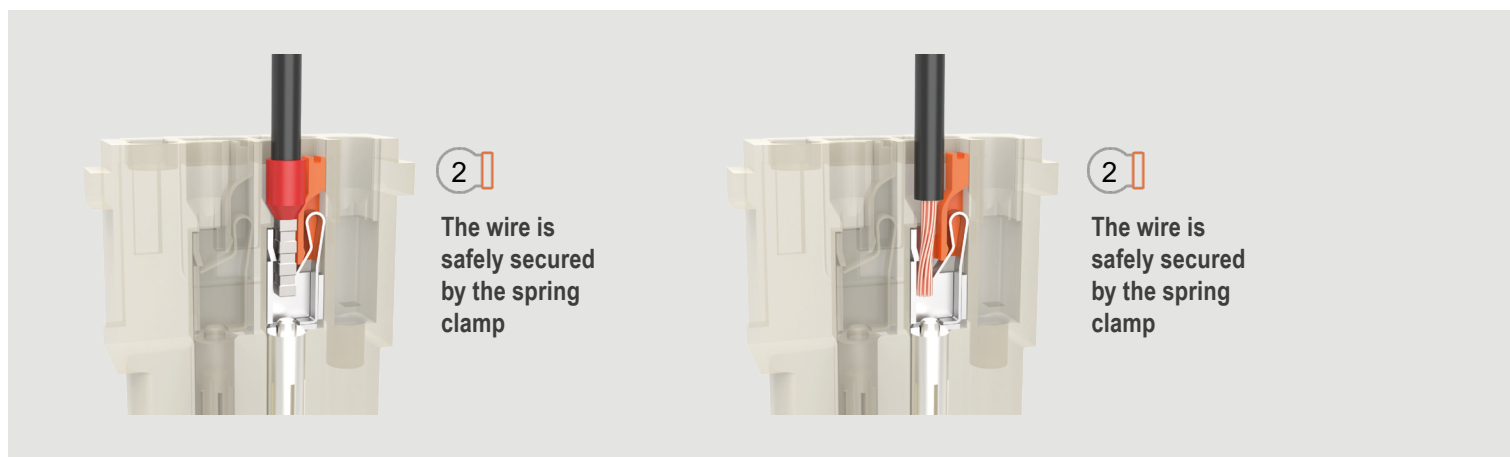
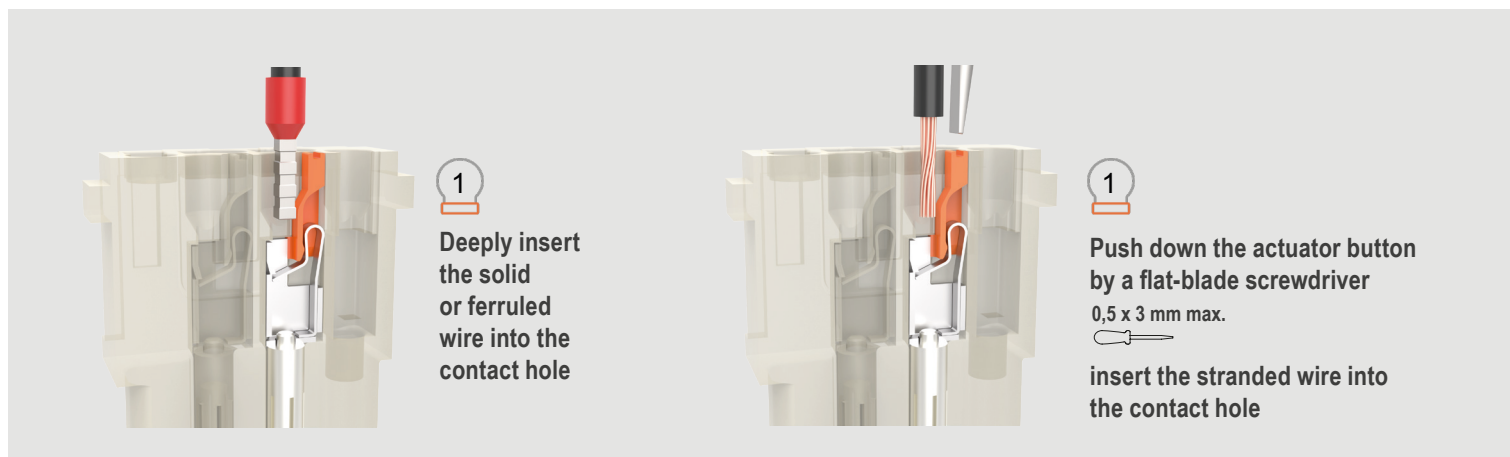

*CSA = Cross-Sectional Area

Re-opening



Push down the actuator button by a flat-blade 0,5 x 3 mm max. screwdriver to remove the wire



AXYR® TECHNOLOGY

ZOOM-IN AND BENEFITS

- ▶ AXYR® connection equals the density of the crimp connection, without need for any crimping tool

Wire release with a **simple** flat-blade screwdriver.

- ▶ AXYR® trademark on the product

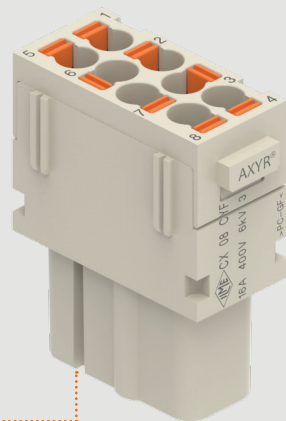

- ▶ **Mateable** with the corresponding crimp versions

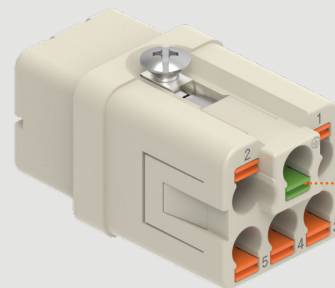

- ▶ AXYR® PE contact

- ▶ **Machined** brass contacts
- ▶ One size fits the **whole range** of cross-sectional areas
- ▶ Suitable for **rigid or ferrule-prepared** stranded wires **as well as** for unprepared stranded wires



- ▶ **Patented** technology



AXYR® PRODUCT RANGE

FOR 16 A CONNECTIONS



Watch
our Video

Inserts		EN 61984 Rating	Poles	Series	Size
CX 06 CYF	CX 06 CYM	16 A 500 V 6 kV 3	6	MIXO	1 module
CX 08 CYF	CX 08 CYM	16 A 400 V 6 kV 3	8	MIXO	1 module
CQYF 05	CQYM 05	16 A 230/400 V 4 kV 3	5 + ⊕	CQ	"21.21"
CQYF 08E	CQYM 08E	16 A 500 V 6 kV 3	8 + ⊕	CQ	"32.13"

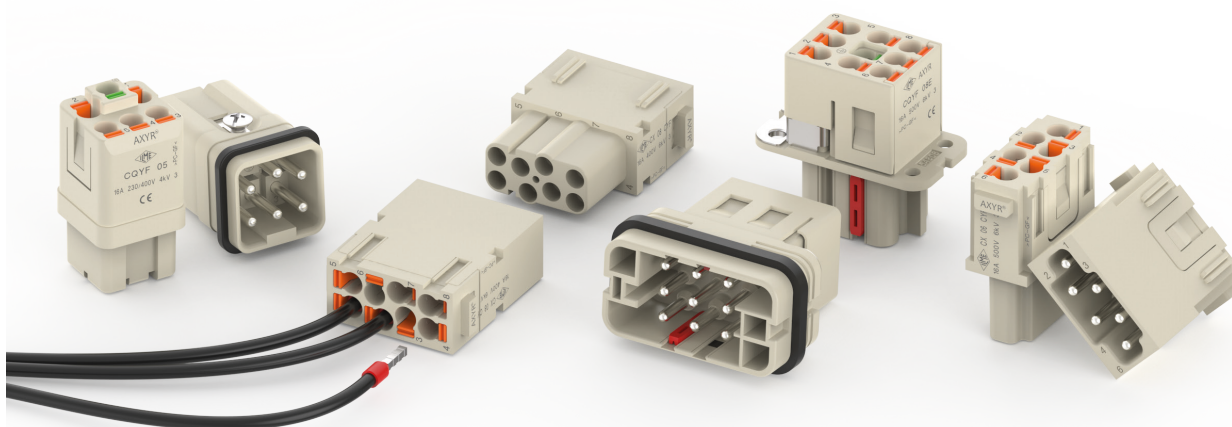

AXYR® 16 A inserts and modules

AXYR®

Product range for 16 A connections

CQY 05 / CQY 08E inserts

MIXO CX 06 CY / CX 08 CY modules

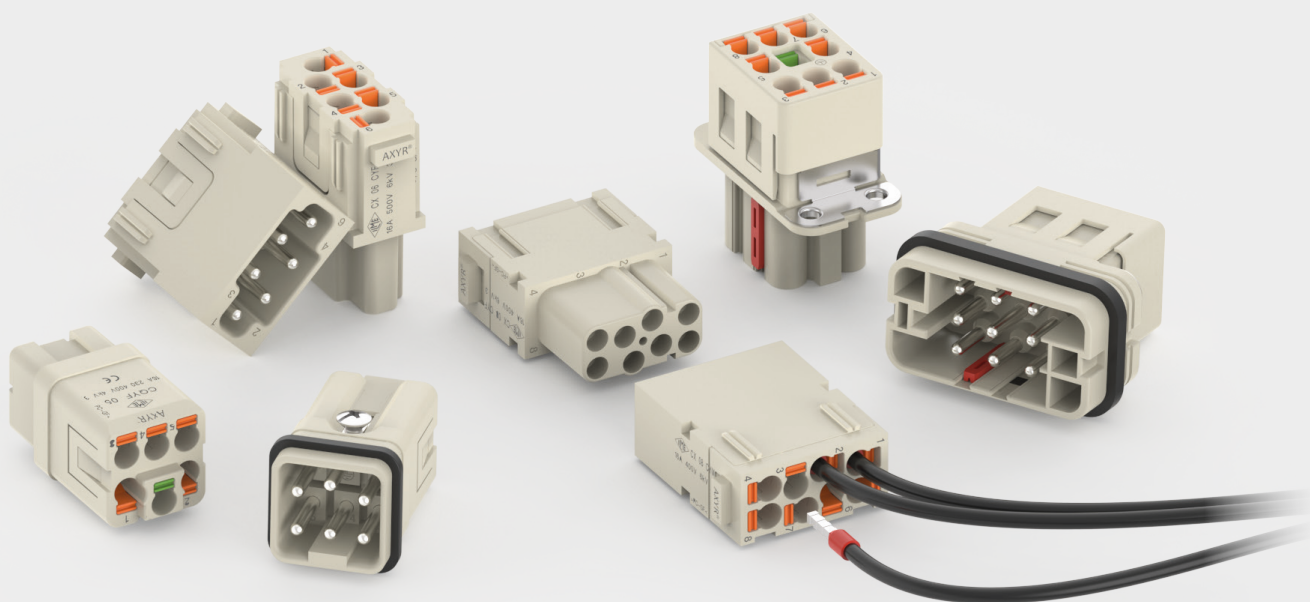

CQY 05 inserts

5 P + ⊕: 16 A 230/400 V 4 kV 3

CQY 08E inserts

8 P + ⊕: 16 A 500 V 6 kV 3

16 A 400/690 V 8 kV 2

MIXO CX 06 CY and CX 08 CY modules

6 P + ⊕: 16 A 500 V 6 kV 3

8 P + ⊕: 16 A 400 V 6 kV 3



Find out more
www.ilme.com

enclosures:
size "21.21"

page:

Insulating type	339 - 348
Metallic type	349 - 363
W-TYPE for aggressive environments	512 - 518
EMC	564 - 572
IP68	628 - 631
E-Xtreme® corrosion proof	538 - 539

page:

COB 03/3 BC 134

refer to CN.19 pages

refer to News 2020 pages

inserts,
AXYR® terminal connections

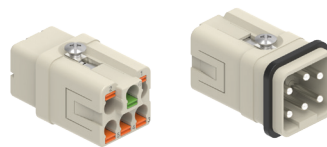

Q SIZE "21.21"
FROM NOVEMBER 2022

description

part No.

spring/AXYR® push-in connection
female inserts with female contacts
male inserts with male contacts

CQYF 05
CQYM 05

- characteristics according to EN 61984:
16 A 230/400 V 4 kV 3

- cURus (ECBT2/8 and PVVA2/8) pending
- CQC, EAC, DNV-GL, BV pending

- rated voltage according to UL/CSA: 600 V
- insulation resistance: $\geq 10 \text{ G}\Omega$
- ambient temperature limit: $-40 \text{ }^\circ\text{C} \dots +125 \text{ }^\circ\text{C}$
- made by UL 94V-0 glass reinforced polycarbonate, EN 45545-2:2015 compliant
- mechanical life: ≥ 500 cycles
- contact resistance: $\leq 3 \text{ m}\Omega$

- for max. current load see the connector inserts derating diagram under construction; for more information see page 28 of CN.19 catalogue

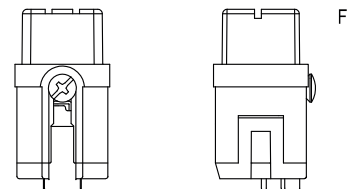
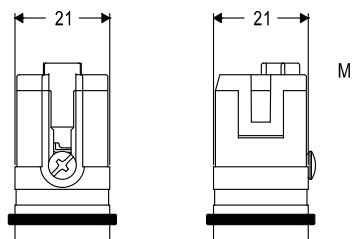

contacts side (front view)

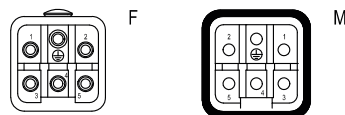

- inserts for conductors with the following cross-sectional areas, either ferruled or unferruled:
0,25 mm² - 2,5 mm² (AWG 24-14)

- conductors stripping length: 9...11 mm

CQYF /M 08E 8 poles + ⊕ 16 A - 500 V

enclosures:
size "32.13"

page:

metallic

38

insulating type
EMC (insulating)

365 - 367
573 - 574

ISO 23570-3
standard and DESINA,
specification compliant



inserts,
AXYR® terminal connections

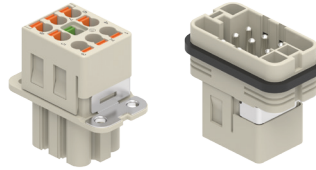

Q SILVER PLATED CONTACTS
FROM NOVEMBER 2022

refer to CN.19 pages

description

part No.

spring/AXYR® push-in connection
female insert with female contacts
male insert with male contacts

CQYF 08E
CQYM 08E

- characteristics according to EN 61984:
16 A 500 V 6 kV 3
16 A 400/690 V 8 kV 2

- cURus (ECBT2/8 and PVVA2/8) pending
- CQC, EAC, DNV-GL, BV pending

- rated voltage according to UL/CSA: 600 V
- insulation resistance: $\geq 10 \text{ G}\Omega$
- ambient temperature limit: $-40 \text{ }^\circ\text{C} \dots +125 \text{ }^\circ\text{C}$
- made by UL 94V-0 glass reinforced polycarbonate,
EN 45545-2:2015 compliant
- mechanical life: ≥ 500 cycles
- contact resistance: $\leq 3 \text{ m}\Omega$

- coded for use with "32.13" metallic enclosures (and insulating enclosures)

- for max. current load see the connector inserts derating diagram under construction; for more information see page 28 of CN.19 catalogue

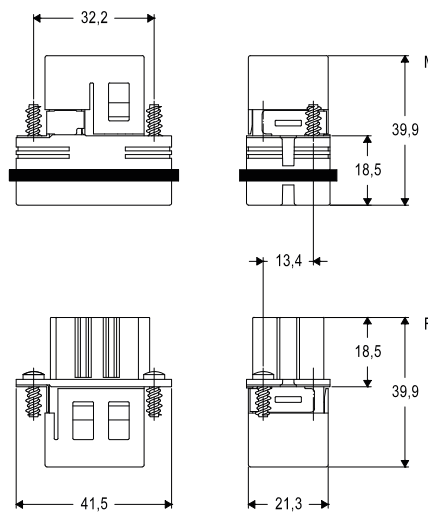

contacts side (front view)

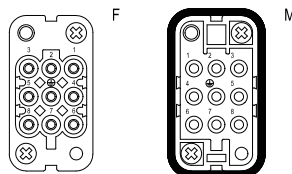

Q Please refer to page 34 for the CQ 08 NEW METAL CONCEPT solution

- inserts for conductors with the following sections
either ferruled or unferruled:
0,25 mm² - 2,5 mm² (AWG 24-14)

- conductors stripping length: 9...11 mm

CR coding pin

coding pin



description

part No.

plastic coding pin

CR Q08E

Q It is possible to achieve up to **6 different codings** thanks to the use of the optional CR Q08E coding pin: 4 coding pins are required for each connector coupling.

Q It is necessary to install two coding pins on each connector part.

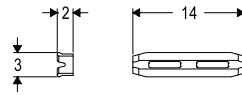

CR Q08E CODING OPTIONS

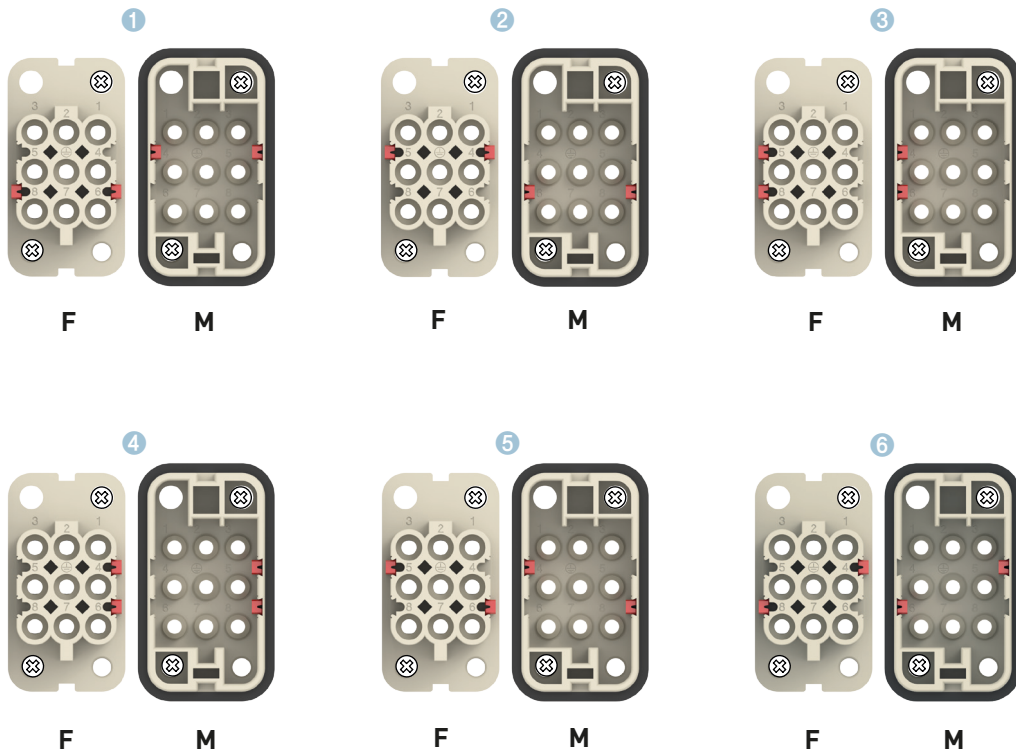

MIXO CX 06 CYF /CYM 6 poles 16 A - 500 V

The modular inserts must be installed in suitable frames which are then mounted in traditional enclosures or in COB panel support.

Single-sized modular units may be directly mounted inside MIXO ONE enclosures.

page:

frames for modular units 316 - 317

MIXO ONE enclosures 369

refer to CN.19 pages

modular units,
AXYR® terminal connections

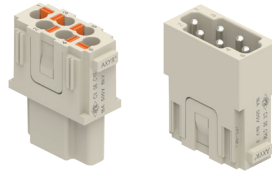

FROM NOVEMBER 2022

description

part No.

spring/AXYR® push-in connection
female inserts with female contacts
male inserts with male contacts

CX 06 CYF
CX 06 CYM

- characteristics according to EN 61984:
16 A 500 V 6 kV 3

- cURus (ECBT2/8 and PVVA2/8) pending
- CQC, EAC, DNV-GL, BV pending

- rated voltage according to UL/CSA: 600 V
- insulation resistance: $\geq 10 \text{ G}\Omega$
- ambient temperature limit: $-40 \text{ }^\circ\text{C} \dots +125 \text{ }^\circ\text{C}$
- made by UL 94V-0 glass reinforced polycarbonate, EN 45545-2:2015 compliant
- mechanical life: ≥ 500 cycles
- contact resistance: $\leq 3 \text{ m}\Omega$

- for max. current load see the connector inserts derating diagram under construction; for more information see page 28 of CN.19 catalogue

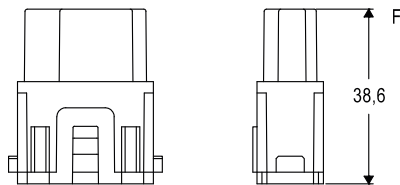
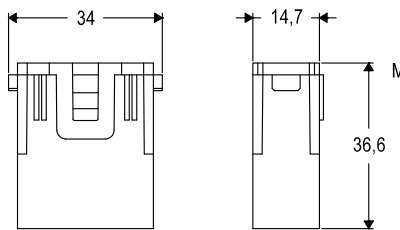

contacts side (front view)

side with reference arrow ▲

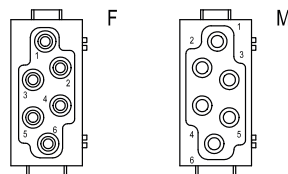

- inserts for conductors with the following cross-sectional areas, either ferruled or unferruled:
0,25 mm² - 2,5 mm² (AWG 24-14)

- conductors stripping length: 9...11 mm

1 frame slot

MIXO CX 08 CYF /CYM 8 poles 16 A - 400 V

The modular inserts must be installed in suitable frames which are then mounted in traditional enclosures or in COB panel support.

Single-sized modular units may be directly mounted inside MIXO ONE enclosures.

page:

frames for modular units

316 - 317

MIXO ONE enclosures

369

refer to CN.19 pages

modular units,
AXYR® terminal connections

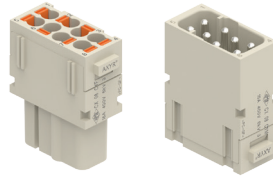

FROM NOVEMBER 2022

description

part No.

spring/AXYR® push-in connection
female inserts with female contacts
male inserts with male contacts

CX 08 CYF
CX 08 CYM

- characteristics according to EN 61984:
16 A 400 V 6 kV 3

- cURus (ECBT2/8 and PVVA2/8) pending
- CQC, EAC, DNV-GL, BV pending

- rated voltage according to UL/CSA: 600 V
- insulation resistance: $\geq 10 \text{ G}\Omega$
- ambient temperature limit: $-40 \text{ }^\circ\text{C} \dots +125 \text{ }^\circ\text{C}$
- made by UL 94V-0 glass reinforced polycarbonate, EN 45545-2:2015 compliant
- mechanical life: ≥ 500 cycles
- contact resistance: $\leq 3 \text{ m}\Omega$

- for max. current load see the connector inserts derating diagram under construction; for more information see page 28 of CN.19 catalogue

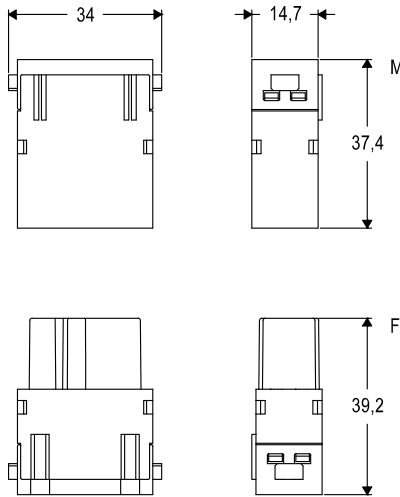

contacts side (front view)

side with reference arrow ▲

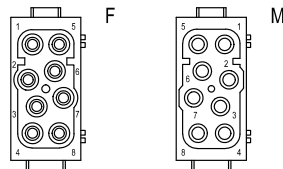

- inserts for conductors with the following cross-sectional areas, either ferruled or unferruled:
0,25 mm² - 2,5 mm² (AWG 24-14)

- conductors stripping length: 9...11 mm

1 frame slot

MIXO MODULE CX 01 YAF /YAM

For 90°-angled screw terminal connection

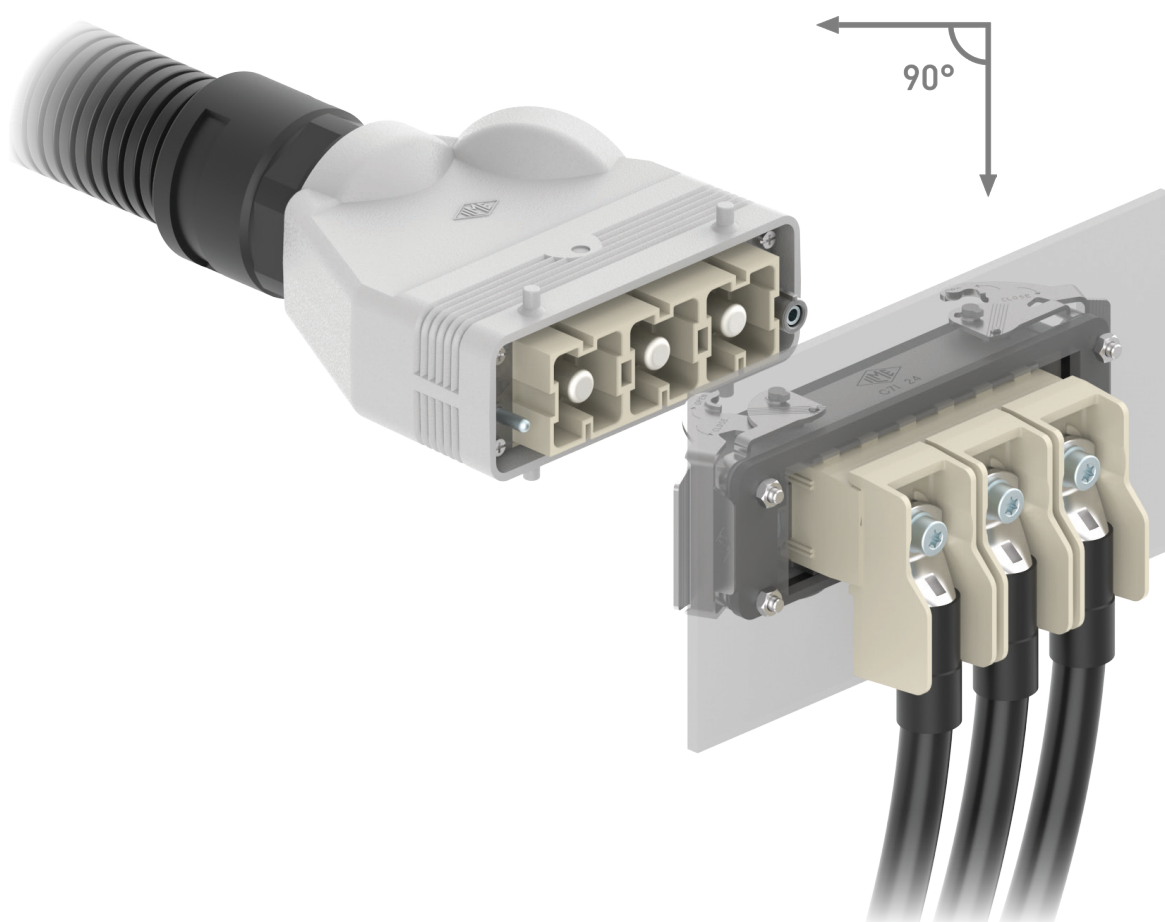

MIXO 200 A

High current module

robust and space-saving

1 P: 200 A 1 000 V 8 kV 3



Find out more
www.ilme.com

TECHNICAL FEATURES



Watch our
technical clip

The ILME modular MIXO system offers incredible versatility and freedom of configuration: more than 66 modules are available to realize a connector fitting everyone's needs.

High-power modules in the 70 A - 200 A current range relate to conductors with large wire-cross-section, even up to 70 mm². Such wires are often difficult to handle, having reduced bending radius and requiring an adequate installation room, often not available.

Q The new **MIXO CX 01 YA** module is the solution introduced by ILME to widen the potential of the MIXO high-current series, a module with the same compatible electrical rating and mating interface of the 200 A crimp version but designed to **minimize its space installation requirements**.

Q The male and female contacts for the angled 200 A module allow the **connection of DIN 46235** pre-insulated crimp cable lugs (using M6 Torx® T30 screw), available on the market in the dimension for wire cross-sectional area of 10 mm², 16 mm², 25 mm², 35 mm², 50 mm² and 70 mm².

Q To keep the proper electrical insulation, ILME designed a **special insulating cover plate**, avoiding accidental contact between cable lugs of adjacent modules and saving the **nominal voltage rating of 1000 V** planned for the 200 A modules.

Q The 200 A angled module can be used inside the ILME bulkhead mounting housings as a natural extension of a busbar connection or for powering control cabinets, HVAC systems and batteries for energy storage backup applications.

► **Original design**

► **Special insulating cover plate** avoiding accidental contact between any conductive element (side by side installation)

► The insulating cover plate design permits the same voltage and impulse withstand voltage rating as the standard 200 A crimp version module, fulfilling the correct creepage and clearance distances requirements

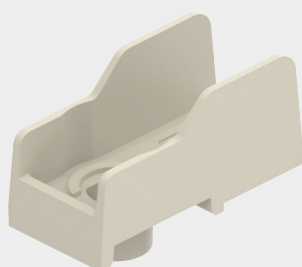

► Suitable for DIN 46235 pre-insulated tubular cable-lugs (not supplied) with wire cross-section: 10 mm² - 70 mm²

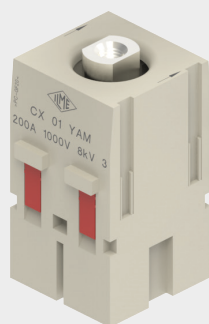

.....► **M6 x 16 mm Torx® T30 socket bolt** to fix the cable lug



.....► **M6 elastic washer** (under the bolt head)



.....► **M6 flat washer** (under the lug)

► Each cable lug can be disconnected without removing the 200 A contact

MIXO CX 01 YAF /YAM 1 pole 200 A - 1000 V

The modular inserts must be installed in suitable frames which are then mounted in traditional enclosures* or in COB panel support.

page: 317

frames for modular units*

* enclosures: bulkhead mounting housings only

refer to CN.19 pages

modular units,
screw terminal connection - 90° angled

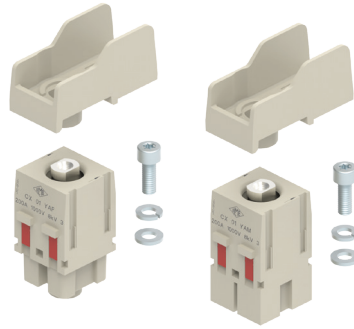

FROM APRIL 2022

description

part No.

screw terminal connection - 90° angled
female insert with female contact
male insert with male contact

CX 01 YAF
CX 01 YAM

- characteristics according to EN 61984:
200 A 1000 V 8 kV 3

- cURus (ECBT2/8 and PVVA2/8) pending
- CSA, CQC, EAC, DNV-GL, BV pending

- rated voltage according to UL/CSA: 600 V
- insulation resistance: $\geq 10 \text{ G}\Omega$
- ambient temperature limit: $-40 \text{ }^\circ\text{C} \dots +125 \text{ }^\circ\text{C}$
- made of self-extinguishing thermoplastic resin UL 94V-0
- mechanical life: ≥ 500 cycles
- contact resistance: $\leq 3 \text{ m}\Omega$

- for max. current load see the connector inserts derating diagram under construction; for more information see page 28 of CN.19 catalogue

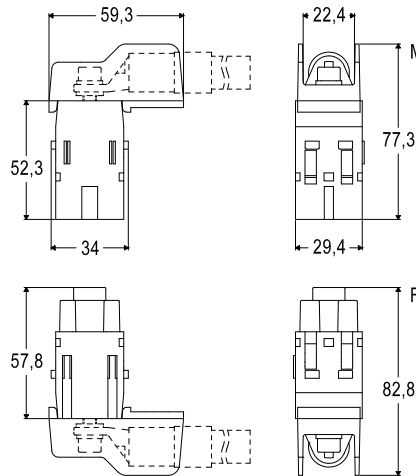

- Pre-insulated tubular cable lug overall width: 22 mm max.

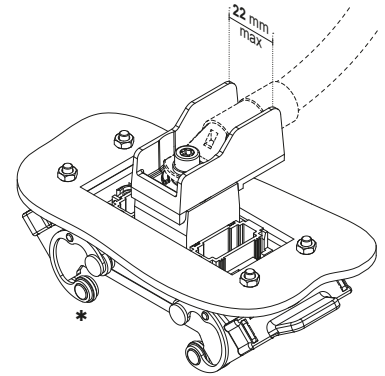

* Frame size, additional MIXO modules and housing levers may vary from those depicted.

contacts side (front view)

side with reference arrow ▲

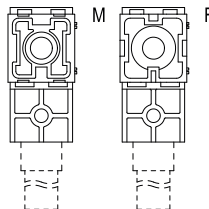

CX 01 YA, 1 pole connector inserts (MIXO 200A)
Maximum current load derating diagram

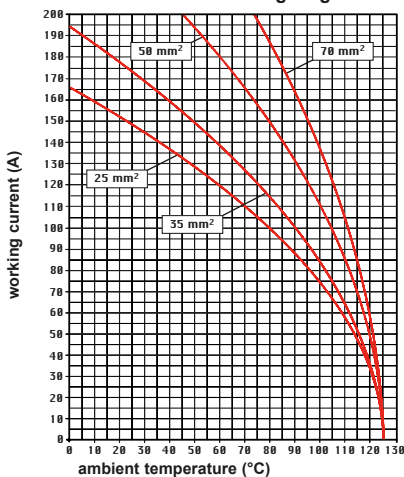

2 frame slots

ASSEMBLY INSTRUCTIONS

CX 01 YAF /YAM - MIXO MODULE 200 A 90°-ANGLED SCREW TERMINATION

1

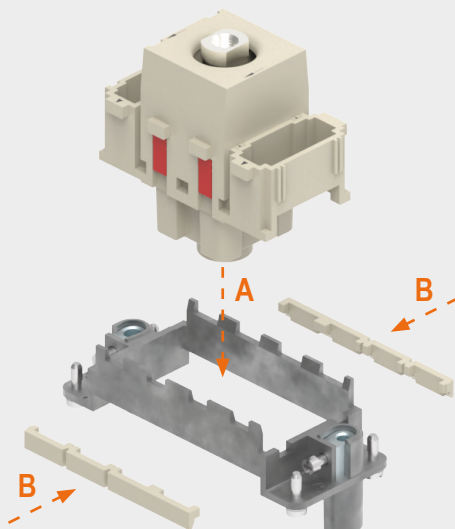

2 For bulkhead mounting housings only

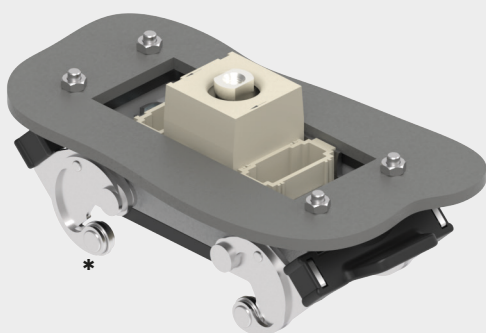

* Frame size, additional MIXO modules and housing levers may vary from those depicted.

3

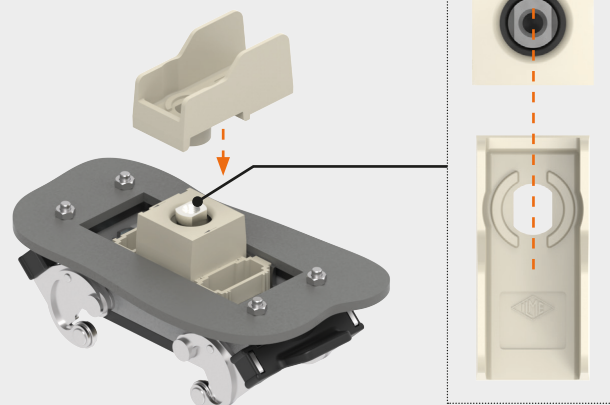

4

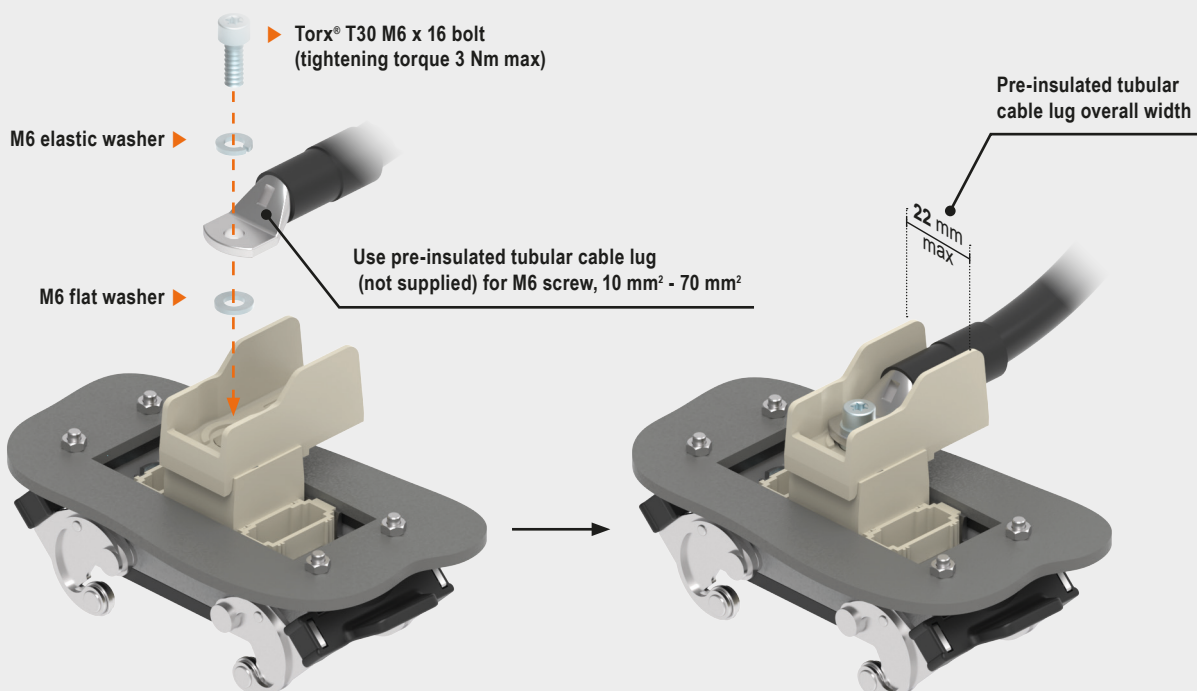

MIXO NOVELTIES

The MIXO series, featuring a flexible modular design for utmost versatile connector creation with easy and safe installation, is again furtherly expanded, with the addition of **3 new modules** (2 single-sized, 1 double-sized, all variants intermateable with existing ones), widening the MIXO portfolio to 66 modules, as follows:

- **CX 06 CYF /CYM**
new MIXO AXYR® 16 A module **22**
single-sized, 6 poles, 16 A (spring/AXYR®)
rating: 500 V 6 kV 3

- **CX 08 CYF /CYM**
new MIXO AXYR® 16 A module **23**
single-sized, 8 poles + shield, 16 A (spring/AXYR®)
rating: 400 V 6 kV 3

- **CX 01 YAF /YAM**
new MIXO 200 A 90° angled module **26**
double-sized, 1-pole, 200 A (90° angled, screw)
rating: 1 000 V 8 kV 3
 high-current connection for tubular cable lugs (not supplied)
 for 10 mm² through 70 mm² conductor cross-sectional area
 (6-2/0 AWG), for M6 lug terminals, max width 22 mm



Find out more
www.ilme.com

In addition to MIXO series advances (page 33), each of the new modules adds the following **individual features**:

- ☒ **high-current, 90° angled screw connection for tubular cable lugs**, at the rear of bulkhead-mounting housings, for tight 90° change of direction of suitably terminated power cables for rated voltages up to 1 000 V and rated currents up to 200 A per pole; mateable with standard counterpart MIXO power crimp modules CX 01 YF/ YM (CX 01 YAF/ YAM);
- ☒ **fast, tool-less AXYR® push-in wiring of 6-pole or 8-pole connections** for up to 16 A per pole at up to 500 V, mateable with standard counterpart MIXO crimp modules CX 06 CF/ CM and CX 08 CF/ CM (MIXO CX 06 CYF/ YM, CX 06 CYF/ CYM).

MIXO SERIES AT A GLANCE

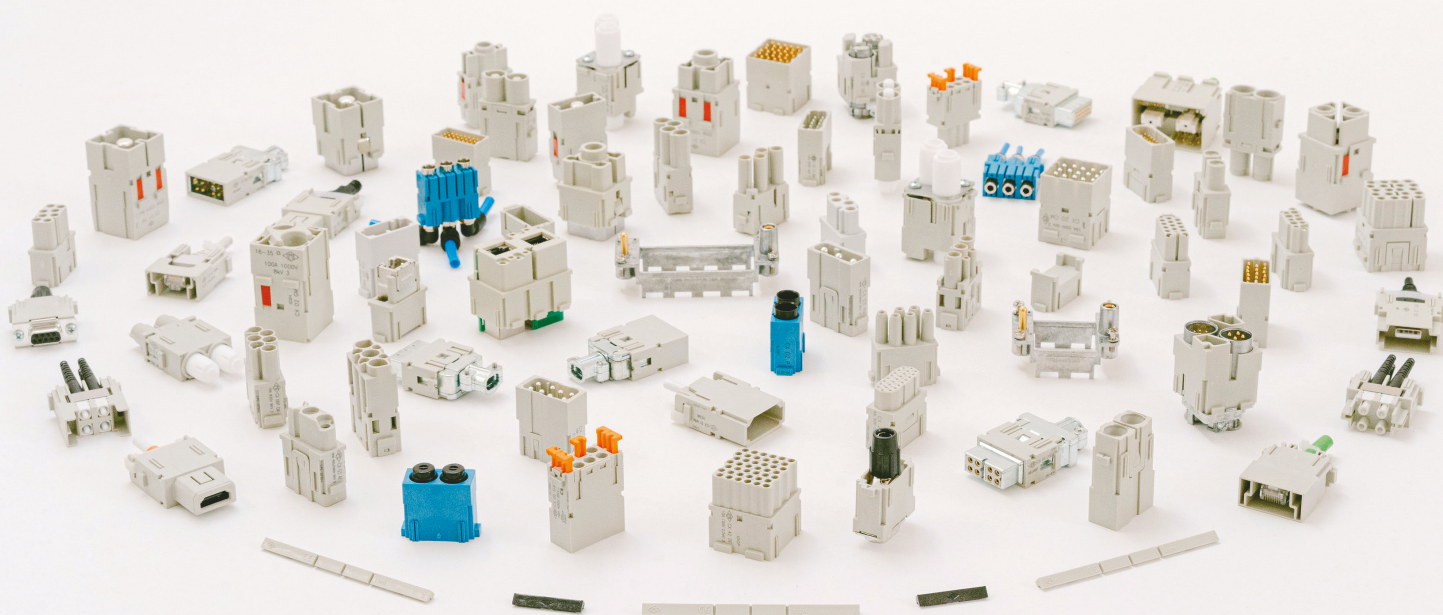

MIXO SERIES

GENERAL OVERVIEW

The MIXO series is a system of modular units for special applications that uses the traditional ILME enclosures. Each enclosure can house different types of connections such as: electric signals and contacts for the conduction of compressed air with pressure values of up to 8 bars.

The inserts are arranged side by side to form a single **compact block** which is inserted into metallic frames with constrained positioning. Once the modules have been inserted and locked with the special tabs, the connector can be placed into the enclosure.

The modular system makes it easy to access a series of contacts inserted in the frame (e.g., for substitution, check or the addition of signals with new inserts for needs not foreseen during the initial installation) without having to disassemble the entire connector.

ILME MIXO series of modular connectors is an open connector system that provides versatile configuration to the users' individual requirements, giving the **freedom to assemble a customized connector** from a range of 66 modules for power electrical, data transmission, optical signals or air. The module range is continuously expanded, allowing new configurations to be realised.

The use of enclosures provides the possibility of innumerable **applications**.

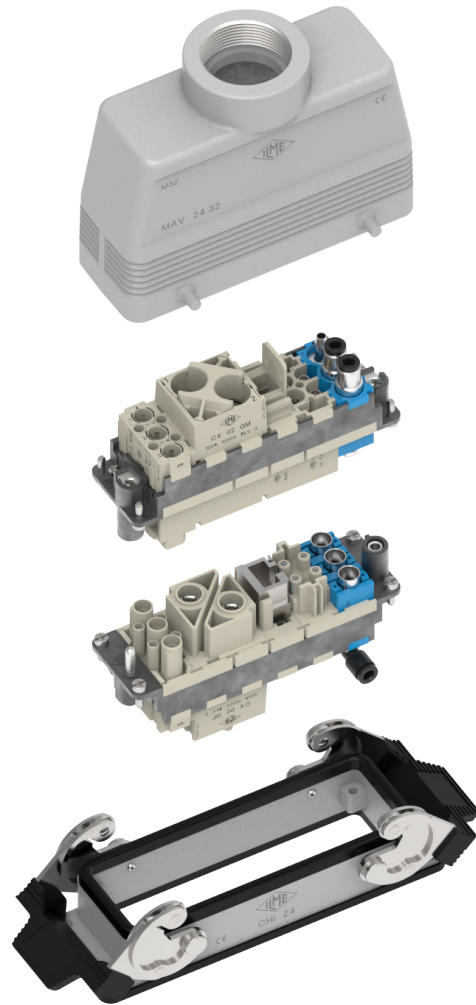

POWER/
SIGNAL



POWER

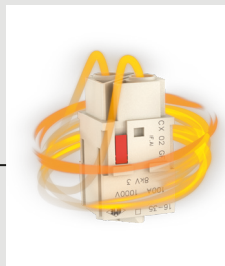

DATA
TRANSMISSION



FIBRE OPTIC

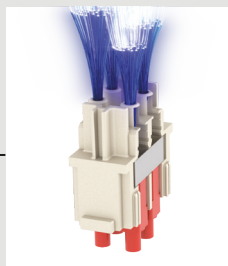

PNEUMATIC

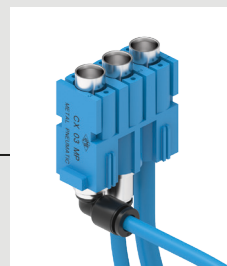

The MIXO series can be used with **5 different frame sizes**:

Frames	one or two-lever metallic enclosures
CX 01 T	size "49.16"
CX 02 TF/ TM	size "44.27"
CX 03 TF/ TM	size "57.27"
CX 04 TF/ TM	size "77.27"
CX 06 TF/ TM	size "104.27"
CX 04 TF/ TM (x 2)	size "77.62"
CX 06 TF/ TM (x 2)	size "104.62"

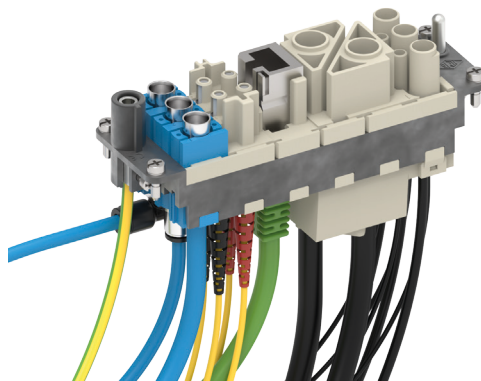

Single sized modules, where specified, can also be installed directly inside **MIXO ONE** enclosures.

CX 01 T
1 module



CX 02 TF/ TM
2 modules



CX 03 TF/ TM
3 modules

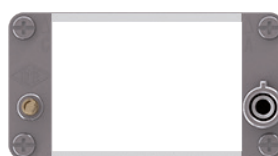

CX 04 TF/ TM
4 modules

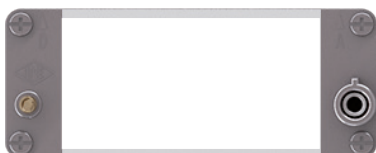

CX 06 TF/ TM
6 modules

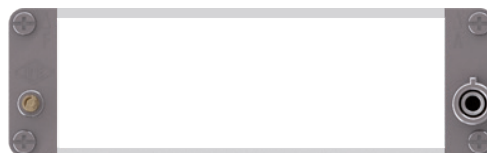

Possibility – to be verified case-by-case – to use the recently added MIXO **HNM frames** (provided with special gold plated PE contacts) together with R series of crimp contacts and the relevant connector

hoods and housings, to produce, where required, an **HNM connector** (High Number of Matings, up to 10 000 cycles of operation).

Fill the unused frame slots with **CX FM dummy module**

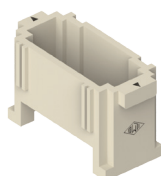

In addition, the MIXO series can be used with the **COB series panel supports**.

Frames	COB panel supports part No.
CX 02 TF/ TM	fixed: COB 06 BC and COB TCQ
	mobile: COB TSF , COB TSFS and COB 06 CMS
CX 03 TF/ TM	fixed: COB 10 BC and COB TCQ
	mobile: COB TSF , COB TSFS and COB 10 CMS

Frames	COB panel supports part No.
CX 04 TF/ TM	fixed: COB 16 BC and COB TCQ
	mobile: COB TSF , COB TSFS and COB 16 CMS
CX 06 TF/ TM	fixed: COB 24 BC and COB TCQ
	mobile: COB TSF , COB TSFS and COB 24 CMS





THE COMPLETE RANGE

2022 products are marked with the symbol .

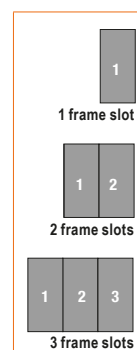
Calculate the number of frame slots taken up by the required inserts (frame slot 1, 2 or 3 modules) and select the right frame according to the number of required modules (available 1, 2, 3, 4 and 6 modules).

Single sized modules, where specified, can also be installed directly inside MIXO ONE enclosures.



Inserts	Contact type	Signal type	Kind of connection	Rated current (A)	Rated voltage (V)	Number of frame slots
CX 01 YF/M	main	electric	crimp	200	1000	2
CX 01 YPEF/M	PE	—	crimp	200	—	2
 CX 01 YAF/M	main	electric	90° screw	200	1000	2
CX 01 GF/M	main	electric	crimp	100	830	1
CX 02 GF/M	main	electric	crimp	100	1000	2
CX 02 7F/M	main	electric	crimp	70	1000	1
CX 02 4AF/M	main	electric	axial screw	40	1000	1
CX 02 4BF/M	main	electric	axial screw	40	1000	1
CX 02 4F/M	main	electric	crimp	40	1000	1
CX 03 4F/M	main	electric	crimp	40	400/690	1
CX 03 4BF/BM	main	electric	crimp	40	500	1
CX 3/4 XDF/M	main / auxiliary	electric	crimp	40/10	830	1
CX 04 XF/M	main	electric	crimp	40	830	1
 CX 05 SF/M	main	electric	spring	16	400	1
CX 05 SHF/M	main	electric	SQUICH®-spring	16	400	1
CX 06 CF/M	main	electric	crimp	16	500	1
CX 06P CF/M	main	electric	crimp	16	830	1
 CX 06 CYF/M	main	electric	AXYR®-spring	16	500	1
CX 08 I6F/M	main + shield	electric	crimp	5	50	1
CX 08 I6GF/I6GM	main + shield	electric	crimp	5	50	1
RX 08 I6F/M	HNM main + shield	electric	crimp	5	50	1
RX 08 I6GF/I6GM	HNM main + shield	electric	crimp	5	50	1
CX 08 D5F/F2 M/M2	main + shield	electric	crimp	10	50	1
CX 08 D5GF/F2 GM/GM2	main + shield	electric	crimp	10	50	1
RX 08 D5F/F2 M/M2	HNM main + shield	electric	crimp	10	50	1
RX 08 D5GF/F2 GM/GM2	HNM main + shield	electric	crimp	10	50	1
 CX 08 CYF/M	main	electric	AXYR®-spring	16	400	1
CX 20 CF/M	main	electric	crimp	16	500	2
CX 12 DF/M	main / auxiliary	electric	crimp	10	250	1
CX 17 DF/M	main / auxiliary	electric	crimp	10	160	1
CX 42 DF/M	main / auxiliary	electric	crimp	10	150	2
CX 25 IBF/M	main / auxiliary	electric	crimp	4	50	1
 CX 25 IF/M	main / auxiliary	electric	crimp	4	50	1
CX 20S IF/M	main / auxiliary + shield	electric	crimp	4	32	1
CX 20S IGF/IGM	main / auxiliary + shield	electric	crimp	4	32	1
RX 20S IF/M	HNM main / auxiliary + shield	electric	crimp	4	32	1
RX 20S IGF/IGM	HNM main / auxiliary + shield	electric	crimp	4	32	1
CX 36 IF/M	main / auxiliary	electric	crimp	4	32	1
CX 02 CHF/M	main	electric	crimp	16	2500	1
CX 02 HF/M	main	electric	crimp	16	2900 / 5000	2
CX 02 4HF/M	main	electric	crimp	40	2900 / 5000	2
CX 02 BF/M	seat for two shielded connectors (refer to CX 04 B, CX 01 B, CX 01 BC, CX 08 B)					
CX 01 BCF/M	main / auxiliary + shield	electric	crimp	16	50	—
CX 01 BF/M	main / auxiliary + shield	electric	crimp	10	50	—
CX 04 BF/M	main / auxiliary + shield	electric	crimp	10	50	—
CX 08 BF/M	main / auxiliary + shield	electric	crimp	5	50	—
CX 03 P	pneumatic plastic Ø 1,6 - 3,0 - 4,0 mm	air	push-in	—	—	1
CX 03 MP	pneumatic metal Ø 3,0 - 4,0 - 6,0 mm	air	push-in / quick-fitting	—	—	1
CX 02 P	pneumatic plastic Ø 6,0 mm	air	push-in	—	—	1
CX FM	none (dummy module)	—	—	—	—	1
CX 01 J8F/M/IM	RJ45	electric	crimp / IDC	—	—	1
CX 01 J8AIF/BIF/PIF	RJ45 + shield	electric	IDC	1	50	1
CX 01 J8UM	RJ45	electric	IDC	—	—	1
CX 01 JF/M	RJ45 + auxiliary	electric	crimp	10	250	2
CX 02 JF/M	RJ45 + auxiliary	electric	crimp	10	250	3
CX 01 UF/M	USB	electric	—	—	—	1
CX 01 9VF/M	D-SUB	electric	crimp	5	50	1
CX 01 9VF2/M2	D-SUB + shield	electric	crimp	5	50	1
CX 01 9VTF	D-SUB	electric	screw	5	50	1
CX 01 MIF/MIM	HDMI	electric	—	—	—	1
CX 04 LF/M	POF / MOST	optic	crimp	—	—	1
CX 04 RF/M	coaxial	electric	crimp	—	—	1
CX 04 SCF/M	SC fibre optic	optic	crimp / glue	—	—	1

 Available upon request

TECHNICAL CHARACTERISTICS

- 1 Pneumatic contacts in metal (or plastic) with hose barb or quick-fitting connection.
- 2 Fibre optic contacts SC type.
- 3 Electric contacts in silver-plated or gold-plated brass with connections to the conductors via crimping, spring clamp or axial screw.
- 4 Modular inserts of identical size with insertion system for forming the complete module and frame lock tab.
- 5 Inserts in self-extinguishing thermoplastic material, reinforced with glass fibre, UL 94V-0 approved, with a working temperature range of -40 °C to +125 °C.
- 6 Inserts in conformance with the requirements of the EN 61984 standard and certified and marked with the UL, CSA, CQC, DNV-GL, BV, EAC marks.
- 7 Inserts with patented "swallowtails" to prevent incorrect coupling.
- 8 Position of contacts identified with numbers or codes on both sides of every insert.
- 9 Male/female module carrier frames with mandatory housings and polarity, in die-cast zinc alloy.
- 10 Module lock tab, may be divided according to the number of modules used; it guarantees a perfect stability of the modules during wiring and coupling/uncoupling of the connectors.
- 11 Asymmetric protective earth contacts (two per frame) with wide contact surface to prevent incorrect coupling; when two or more identical connectors of the MIXO series are used, coded pins may prevent incorrect coupling.
- 12 Captive frame fastening screws, with spring washer.
- 13 Dummy module for unused frame slots.

ADVANTAGES

- ☑ Easy and user-friendly assembly of the complete multi-module insert before fixing it on the relevant sized metal frame;
- ☑ use of proprietary ILME technology providing each module with "swallowtails" (lateral keys/keyways), for reciprocal locking of modules and overall assembly of the insert into rigid (non hinged) frames with snap-in locking strips;
- ☑ faster and easier assembly compared with competitor solutions (easier handling of modules as a complete block than e.g. 6 independent parts);
- ☑ intermateability at "complete connector" (modules in frame) with other industry standard products;
- ☑ robust and long lasting prevailing crimp connection technology (largely preferred over screw type technology in high vibration and shock environments).

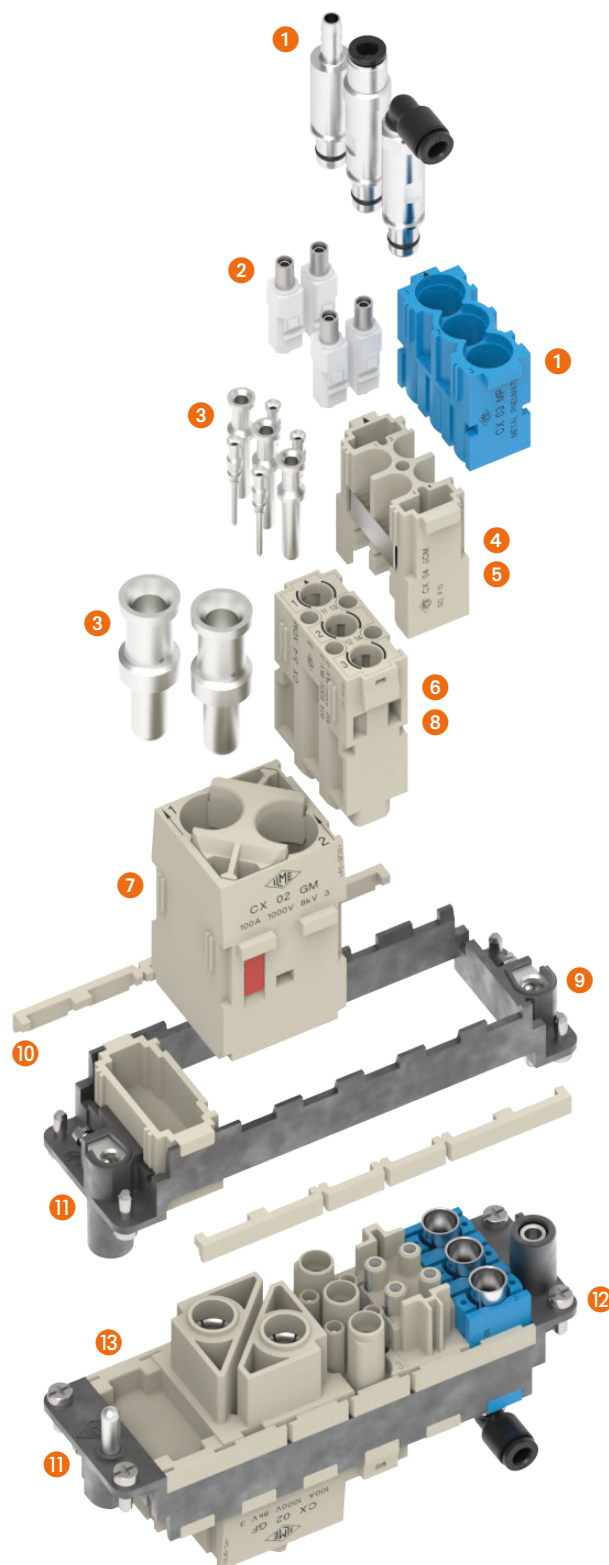

Watch our
MIXO series Video

CQA/MQA 08 SIZE “32.13”

Compact, metallic enclosures with stainless steel lever

AXYR® CQYF /M 08E - CRIMP CQF /M 08E

New inserts in crimp and AXYR® technology

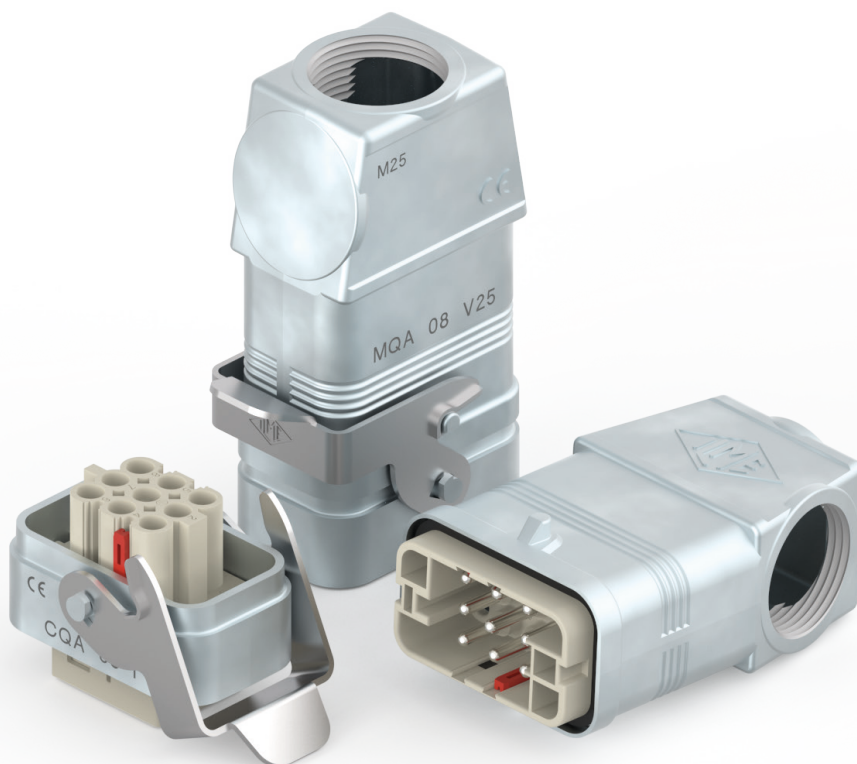

**CQA 08 I, MQA 08 025 /V25 enclosures
size “32.13” for new connectors with PE plate**

CQ connectors 8 P + ⊕ with PE plate

AXYR® CQYF /M 08E	}	16 A	500 V	6 kV	3
Crimp CQF /M 08E		16 A	400/690 V	8 kV	2



Find out more
www.ilme.com

TECHNICAL FEATURES



Watch our
technical clip

The new **metallic enclosures CQA/MQA size “32.13”** have been developed with utmost ease of assembly and simplicity in mind.

Being metallic, these new zinc alloy, zinc plated die cast enclosures, require proper bonding to protective earth (PE), for safety reasons. The existing solutions on the market, in order to fulfil this requirement and provide a safety-robust design in line with the mandatory CE marking statement for such devices, were unsatisfactory in this regard: such a compact design leaves no space for including a separate PE terminal inside the hoods/housings without implying the split of the hood/housing in two parts – thus adding at least two screws and one sealing gasket – and the presence of an additional arm and screw terminal inside the hood, likely to obstruct the wiring space, thus making the assembly utterly complex, expensive, and prone to additional troubles in keeping the high IP degree of protection provided by such enclosures.

On the other hand, insulating enclosures do not provide – although special insulating metallized EMC versions CQS 08 (CN.19 pages 573-575) exist – the necessary shielding of electromagnetic interference that the “32.13” connector inserts typically require for being used in conjunction with pulse width modulation (PWM) drives (inverters) for electric motors’ speed/torque motion control, systems that are likely to produce significant harmonic pollution.

The new metallic enclosures, provided with a robust stainless steel locking lever, have their outer surface protected against corrosion by a conductive layer of galvanic zinc plating, thus they can easily serve as **EMC enclosures**, once provided with commercially available M25 EMC cable glands, and by replacing the standard rubber sealing gasket provided with the dedicated “32.13” male inserts with special conductive sealing gasket **CR 08 EMC** (see CN.19 page 575).

- Q New metallic enclosures CQA/MQA size “32.13”** were therefore demanded to serve such applications. The solution envisaged is to let the “32.13” connector inserts provide such bonding to the surrounding metal hood/housing via a **newly introduced PE plate** reliably in contact with their PE male or female contact.

In order to dumb-proof avoid possibly hazardous mounting of any previously available connector inserts not provided with such PE plate (i.e.: CQF /M 08, CQF /M 04/2, CQF /M 17) into these **new series CQA/MQA metallic enclosures**, these ones have been provided by **internal keys** that match only with the corresponding **keyways** foreseen on the new inserts **CQYF /M 08E (AXYR®)** and **CQF /M 08E (crimp)**, the only ones suitable for these enclosures.
- Q The new AXYR® CQYF /M 08E connector inserts** have been developed already equipped with such additional PE plate, so as to be immediately available for installation either on the traditional insulating housings series CQ/MQ, or on the **new size “32.13” series CQA/MQA metallic enclosures**.
- Q The existing crimp equivalent inserts CQF /M 08** – unsuitable for metallic hoods/housings – needed to be complemented by a new variant, equipped with such additional PE plate; thus, the **new crimp version CQF /M 08E** (where the E after the polarity means presence of PE plate) is also suitable for use either inside traditional size “32.13” CQ/MQ insulating enclosures or inside the **new size “32.13” series CQA/MQA metallic enclosures**.

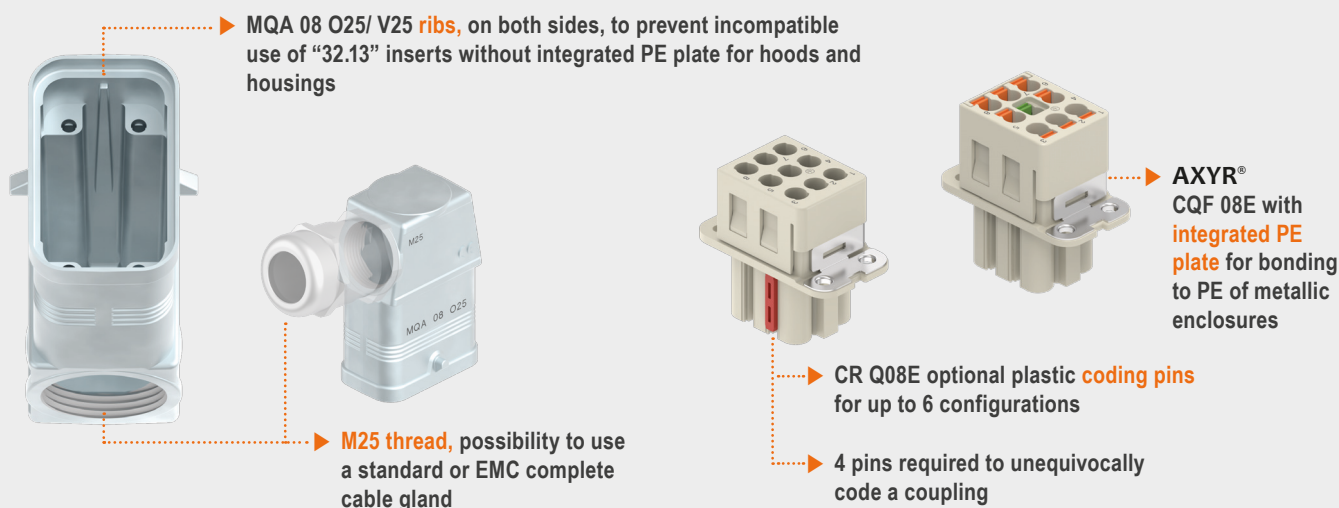

CQYF /M 08E 8 poles + ⊕ 16 A - 500 V

enclosures:
size "32.13"

page:

metallic

38

insulating type
EMC (insulating)

365 - 367
573 - 574

ISO 23570-3
standard and DESINA®
specification compliant



refer to CN.19 pages

inserts,
AXYR® terminal connections

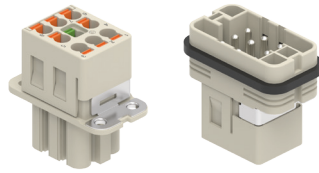

Q SILVER PLATED CONTACTS
FROM NOVEMBER 2022

description

part No.

spring/AXYR® push-in connection
female inserts with female contacts
male inserts with male contacts

CQYF 08E
CQYM 08E

- characteristics according to EN 61984:

16 A 500 V 6 kV 3
16 A 400/690 V 8 kV 2

- cURus (ECBT2/8 and PVVA2/8) pending
- CQC, EAC, DNV-GL, BV pending

- rated voltage according to UL/CSA: 600 V
- insulation resistance: $\geq 10 \text{ G}\Omega$
- ambient temperature limit: $-40 \text{ }^\circ\text{C} \dots +125 \text{ }^\circ\text{C}$
- made by UL 94V-0 glass reinforced polycarbonate,
EN 45545-2:2015 compliant
- mechanical life: ≥ 500 cycles
- contact resistance: $\leq 3 \text{ m}\Omega$
- each insert supplied with 2 fixing screws,
self-tapping, zinc plated steel $\varnothing 2,9 \times 9,5 \text{ mm}$, Ph1

- for max. current load see the connector inserts
derating diagram under construction; for more
information see page 28 of CN.19 catalogue

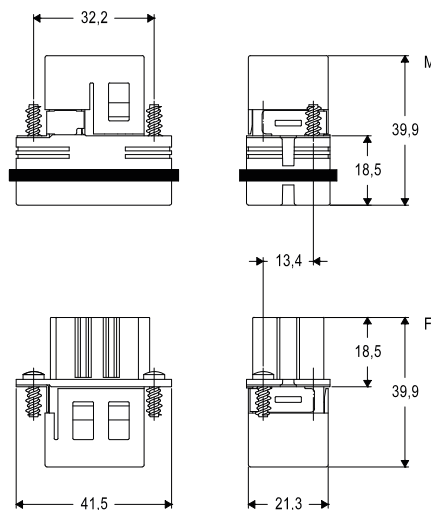

contacts side (front view)

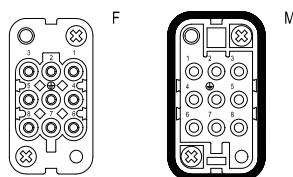

Q Please refer to page 18
to find out more about
AXYR® technology
and the full 16 A range

- inserts for conductors with the following sections
either ferruled or unferruled:
0,25 mm² - 2,5 mm² (AWG 24-14)

- conductors stripping length: 9...11 mm

Coding pin
CR Q08E
(refer to page 39)



enclosures:
size "32.13"

page:

metallic

38

insulating type
EMC (insulating)

365 - 367
573 - 574

ISO 23570-3
standard and DESINA®
specification compliant



refer to CN.19 pages

inserts,
crimp connections

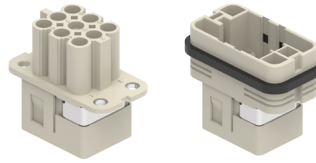

FROM MAY 2022

16 A crimp contacts
standard or for advanced opening
silver and gold plated



STANDARD

ADVANCED
OPENING

description

part No.

without contacts (to be ordered separately)
female insert for female contacts
male insert for male contacts

CQF 08E
CQM 08E

16 A female contacts

0,14-0,37 mm ²	AWG 26-22	one groove
0,5 mm ²	AWG 20	with no grooves
0,75 mm ²	AWG 18	one groove (back side)
1 mm ²	AWG 18	one groove
1,5 mm ²	AWG 16	two grooves
2,5 mm ²	AWG 14	three grooves
3 mm ²	AWG 12	one wide groove
4 mm ²	AWG 12	with no grooves

16 A male contacts

0,14-0,37 mm ²	AWG 26-22	one groove
0,5 mm ²	AWG 20	with no grooves
0,75 mm ²	AWG 18	one groove (back side)
1 mm ²	AWG 18	one groove
1,5 mm ²	AWG 16	two grooves
2,5 mm ²	AWG 14	three grooves
3 mm ²	AWG 12	one wide groove
4 mm ²	AWG 12	with no grooves

16 A male crimp contacts for advanced opening

0,5 mm ²	AWG 20	with no grooves
0,75 mm ²	AWG 18	one groove (back side)
1 mm ²	AWG 18	one groove
1,5 mm ²	AWG 16	two grooves
2,5 mm ²	AWG 14	three grooves

CCFA 0.3
CCFA 0.5
CCFA 0.7
CCFA 1.0
CCFA 1.5
CCFA 2.5
CCFA 3.0
CCFA 4.0

silver plated

CCFD 0.3
CCFD 0.5
CCFD 0.7
CCFD 1.0
CCFD 1.5
CCFD 2.5
CCFD 3.0
CCFD 4.0

gold plated*

CCMA 0.3
CCMA 0.5
CCMA 0.7
CCMA 1.0
CCMA 1.5
CCMA 2.5
CCMA 3.0
CCMA 4.0

CCMD 0.3
CCMD 0.5
CCMD 0.7
CCMD 1.0
CCMD 1.5
CCMD 2.5
CCMD 3.0
CCMD 4.0

CC 0.5 AN
CC 0.7 AN
CC 1.0 AN
CC 1.5 AN
CC 2.5 AN

* for basic or high thickness
gold plating, please refer to
CN.19 at page 675

- characteristics according to EN 61984:

16 A 500 V 6 kV 3
16 A 400/690 V 8 kV 2

- cURus (ECBT2/8 and PVVA2/8) pending
- CQC, EAC, DNV-GL, BV pending
- rated voltage according to UL/CSA: 600 V
- insulation resistance: $\geq 10 \text{ G}\Omega$
- ambient temperature limit: $-40 \text{ }^\circ\text{C} \dots +125 \text{ }^\circ\text{C}$
- made by UL 94V-0 glass reinforced polycarbonate, EN 45545-2:2015 compliant
- mechanical life: ≥ 500 cycles
- contact resistance: $\leq 1 \text{ m}\Omega$
- each insert supplied with 2 fixing screws, self-tapping, zinc plated steel $\varnothing 2,9 \times 9,5 \text{ mm}$, Ph1
- **it is recommended to crimp the contacts with crimping tools homologated by ILME** (please refer to the crimping tool section 16 A contacts, CCF, CCM and CC...AN series on CN.19, pp 708-741)
- for max. current load see the connector inserts derating diagram below; for more information see page 28 of CN.19 catalogue

CQ 08E poles connector inserts
Maximum current load derating diagram

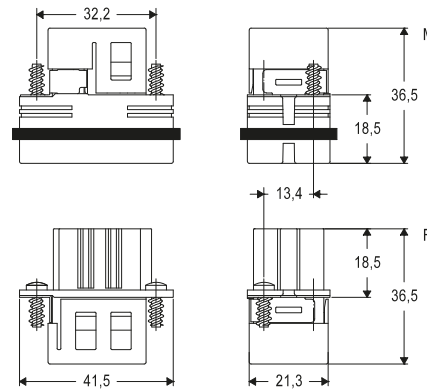
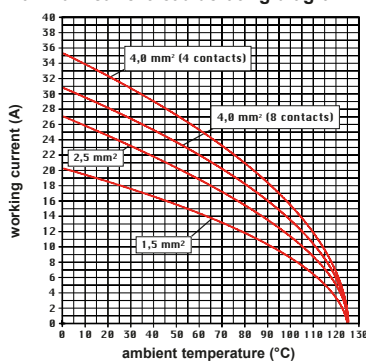

contacts side (front view)

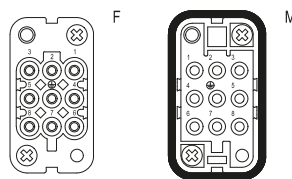

Coding pin
CR Q08E
(refer to page 39)



CCF and CCM

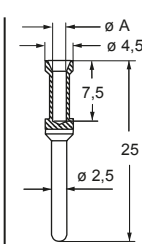

CC...AN

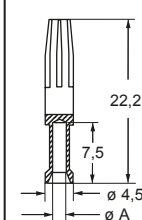
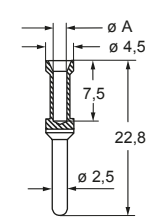

CCF, CCM and CC...AN contacts

conductor section mm ²	conductor slot $\varnothing A$ (mm)	conductors stripping length (mm)
0,14-0,37	0,9	7,5
0,5	1,1	7,5
0,75	1,3	7,5
1,0	1,45	7,5
1,5	1,8	7,5
2,5	2,2	7,5
3	2,55	7,5
4	2,85	7,5

CQA - MQA Metallic version

inserts		page:
CQY 08E	8 poles + ⊕	36
CQ 08E	8 poles + ⊕	37

bulkhead mounting housings with single lever



FROM MAY 2022

hoods with 2 pegs



FROM MAY 2022

description	part No.	part No.	entry M
with lever and gasket	CQA 08 I		
with pegs, side entry		MQA 08 O25	25
with pegs, top entry		MQA 08 V25	25

- cURus (ECBT2/8) pending
- CQC, EAC, DNV-GL, BV pending
- ambient temperature limit: -40 °C ... +125 °C

- zinc die-cast, zinc plated
- stainless steel lever
- NBR flange gasket (interface gasket provided with male insert, where applicable)
- EMC (with suitable cable glands) and replacement of interface gasket on male insert with CR 08 EMC (refer to CN.19, page 575)
- top/side M25 cable entry

IMPORTANT NOTE:
coded for use with "32.13"
PE inserts only.



CQA 08 I

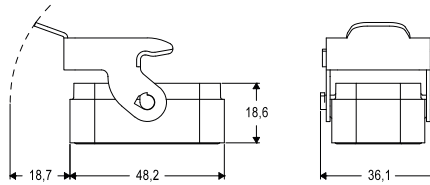

panel cut-out

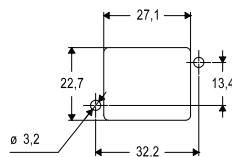

MQA 08 O25

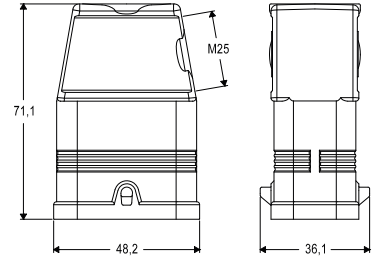

MQA 08 V25

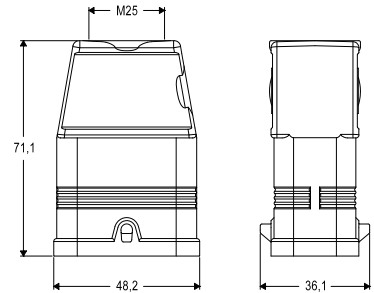

cURus
Type 4/4X/12 pending



according to IEC/EN 60529

CR coding pin

coding pin



description

part No.

plastic coding pin

CR Q08E

Q It is possible to achieve up to **6 different codings** thanks to the use of the optional CR Q08E coding pin: 4 coding pins are required for each connector coupling.

Q It is necessary to install two coding pins on each connector part.

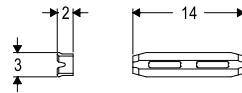

CR Q08E CODING OPTIONS

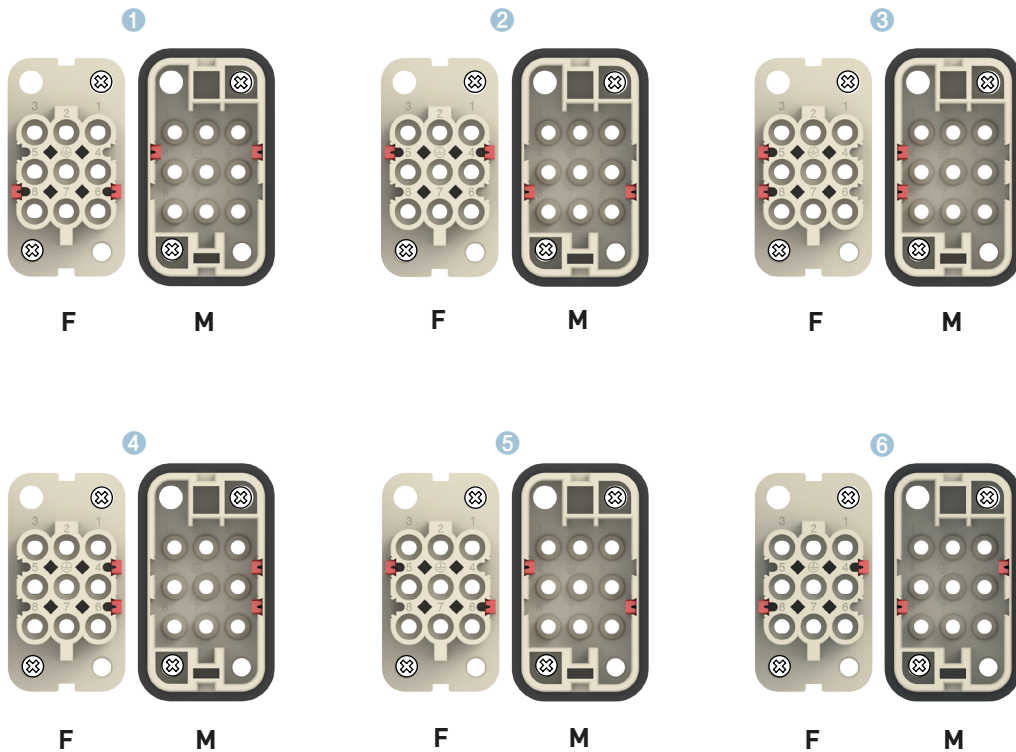

IL-BRID LOCKING LEVERS For standard size enclosures

CL – ML

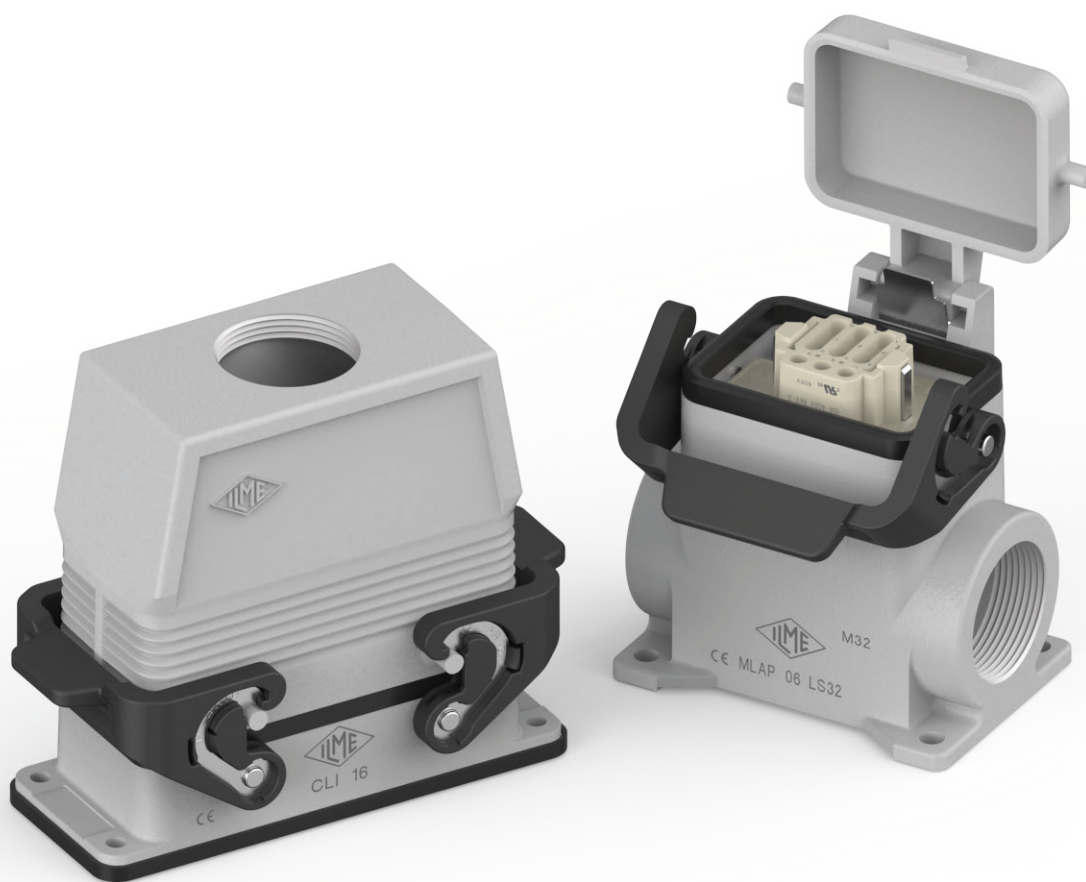

**Proprietary design
with embedded stainless steel core
to protect industrial multipole
connections**



Find out more
www.ilme.com

TECHNICAL FEATURES



Watch our
technical clip

Specific industrial applications demand the design of equally customized connection solutions capable of covering each distinct installation requirement.

Among the enclosures' locking systems introduced by ILME in its product offer, the IL-BRID mechanism, a lever in thermoplastic material with a stainless-steel core, combines the technical characteristics of both these materials for durable but significantly low-wear design.

The **IL-BRID locking lever**, already introduced in the compact "CZ" and "MZ" size "49.16" and "66.16" enclosures series, is **now extended** to the whole ILME enclosures range for standard industrial applications, with the designation "**CL**" and "**ML**" in the bulkhead/surface mount housing or hood with lever versions, sizes "44.27", "57.27", "77.27" and "104.27".

The IL-BRID locking lever is **compatible** with the entire range of ILME enclosures with pegs (in single or double-lever configuration), offering an IP65 or IP66/IP69 degree of protection according to model.

The series, with standard metric M cable entries where foreseen, is also available, upon request, **with Pg or NPT cable entries** (surface housing or hood with levers).

Main technical and functional characteristics:

- Q **locking lever** made of self-extinguishing thermoplastic material (UL approved) and stainless-steel core;
- Q **improved closing mechanism** with reduced wear on the pegs of the enclosure's counterpart;
- Q **proprietary, ergonomic handles design** for an easy opening and closing operation;
- Q **IP65 or IP66/IP69** degree of protection according to EN 60529 (depending on model);
- Q **reduced occupation** of space on the outer edges thanks to a curved design;
- Q **reversibility of the lever** in the bulkhead housing versions (the locking levers can be mounted on the counterpart hood).

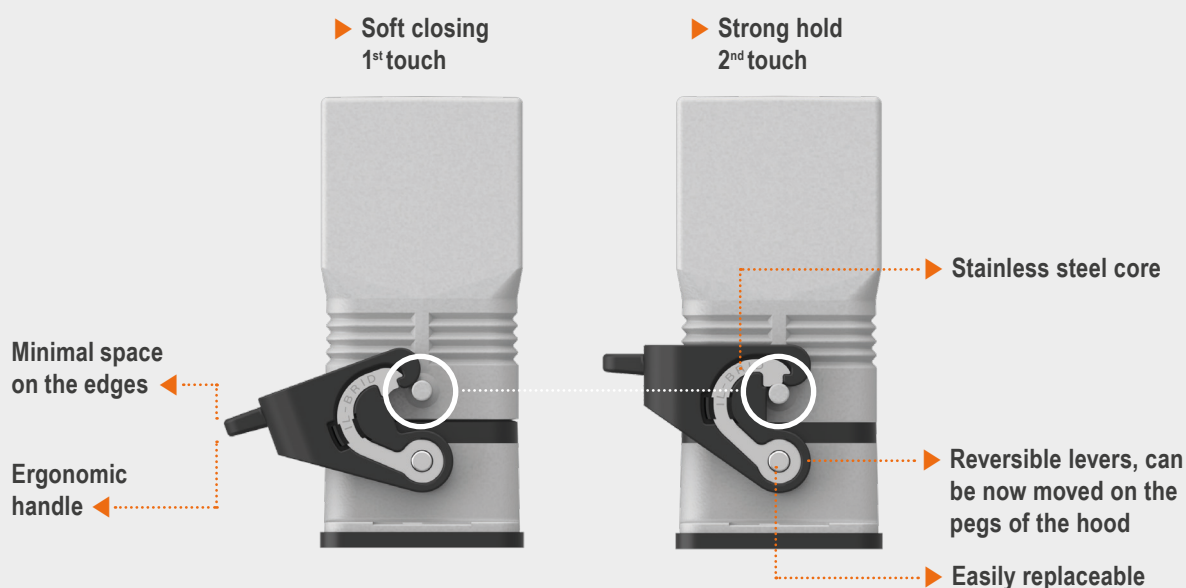

CL – ML Standard version with IL-BRID levers

inserts		page:
CDD	24 poles + ⊕	76
CDS	9 poles + ⊕	-
CDSH	9 poles + ⊕	86
CDSH NC	6 poles + ⊕	95
CNE	6 poles + ⊕	110
CSE	6 poles + ⊕	-
CSH	6 poles + ⊕	110
CSH S	6 poles + ⊕	122
CCE	6 poles + ⊕	130
CSS	6 poles + ⊕	148
CT, CTSE (16A)*	6 poles + ⊕	160
CQE	10 poles + ⊕	168
MIXO	2 modules	262 - 317

* can be used only in bulkhead mounting housings

refer to CN.19 pages

bulkhead mounting housings with single lever



FROM SEPTEMBER 2022

surface mounting housings with single lever



FROM SEPTEMBER 2022

description	part No.	entry M
with lever	CLI 06 L	
with lever and cover	CLI 06 LS	
with lever	MLP 06 L20	20
with lever	MLP 06 L220	20 x 2
with lever, high construction	MLAP 06 L25	25
with lever, high construction	MLAP 06 L225	25 x 2
with lever, high construction	MLAP 06 L32	32
with lever, high construction	MLAP 06 L322	32 x 2
with lever, high construction	MLAP 06 L40	40
with lever, high construction	MLAP 06 L240	40 x 2
with lever and cover	MLP 06 LS20	20
with lever and cover	MLP 06 LS220	20 x 2
with lever and cover, high construction	MLAP 06 LS32	32
with lever and cover, high construction	MLAP 06LS232	32 x 2
with lever and cover, high construction	MLAP 06 LS40	40
with lever and cover, high construction	MLAP 06LS240	40 x 2

panel cut-out for bulkhead mounting housings

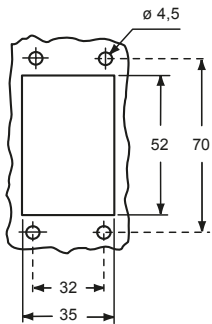

IMPORTANT NOTE: The enclosures ensure IP66/IP69 degree of protection (or IP65 for hinged cover versions) when mated and locked with the closing levers.

cURus
Type 4/4X/12 pending
(except enclosures with plastic cover)

- insulating cable gland or fittings without gasket
- cable gland with O-Ring gasket

CLI 06 L ▲

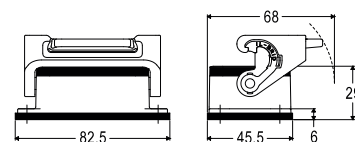

CLI 06 LS ●

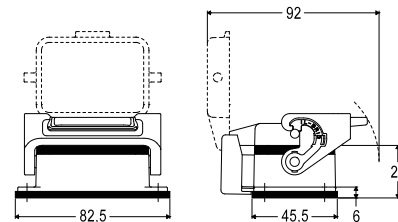

MLP 06 L

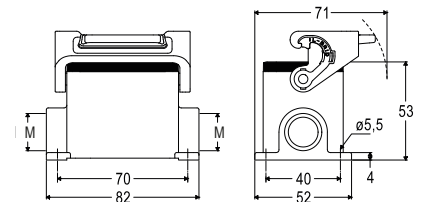

MLAP 06 LS ●

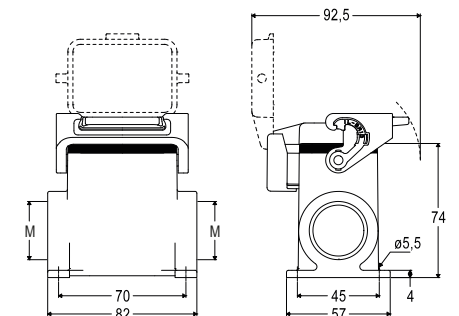

ML – MLA Standard version with IL-BRID levers

inserts

CDD	24 poles + ⊕	76
CDS	9 poles + ⊕	-
CDSH	9 poles + ⊕	86
CDSH NC	6 poles + ⊕	95
CNE	6 poles + ⊕	110
CSE	6 poles + ⊕	-
CSH	6 poles + ⊕	110
CSH S	6 poles + ⊕	122
CCE	6 poles + ⊕	130
CSS	6 poles + ⊕	148
CQE	10 poles + ⊕	168
MIXO	2 modules	262 - 317

page:

hoods with 1 lever



hoods with 1 lever

M40 cable entry with 20 mm thread length



refer to CN.19 pages

FROM SEPTEMBER 2022

FROM SEPTEMBER 2022

description	part No.	entry M	part No.	entry M
with lever, top entry	MLV 06 LG25	25		
with lever, top entry, high construction	MLAV 06 LG25	25		
with lever, top entry, high construction	MLAV 06 LG32	32		
with lever, side entry, high construction, without adapter ¹⁾			MLFO 06 LG40	40
with lever, top entry, high construction, without adapter ¹⁾	MLFV 06 LG25	25		
with lever, top entry, high construction, without adapter ¹⁾	MLFV 06 LG32	32		
with lever, top entry, high construction, without adapter ¹⁾	MLFV 06 LG40	40		

¹⁾ enclosure without adapter, threaded on the body, to be used only with a complete cable gland.

MLV 06 LG

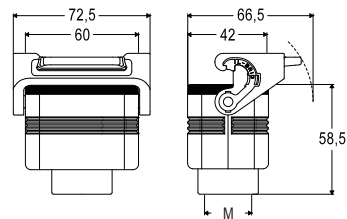

MLAV 06 LG

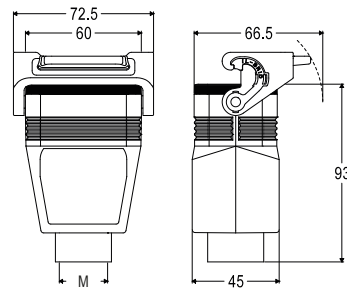

MLFV 06 LG

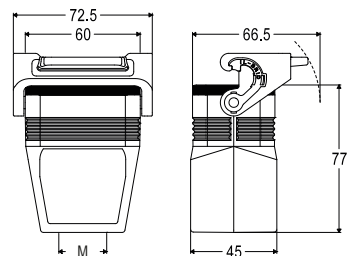

MLFO 06 LG

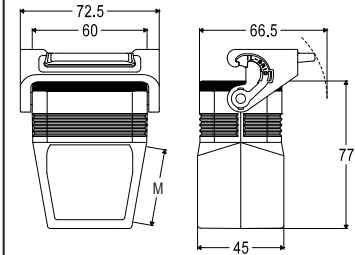

cURus
Type 4/4X/12 pending

insulating cable gland or fittings without gasket

cable gland with O-Ring gasket

CL - ML Standard version with IL-BRID levers

inserts		page:
CDD	42 poles + ⊕	78
CDS	18 poles + ⊕	-
CDSH	18 poles + ⊕	87
CNE	10 poles + ⊕	111
CSE	10 poles + ⊕	-
CSH	10 poles + ⊕	111
CSH S	10 poles + ⊕	123
CCE	10 poles + ⊕	131
CMSH	3+2 (aux) poles + ⊕	136
CMCE	3+2 (aux) poles + ⊕	137
CSS	10 poles + ⊕	149
CT, CTSE (16A)*	10 poles + ⊕	161
CQE	18 poles + ⊕	169
CX	8/24 poles + ⊕	194
MIXO	3 modules	262 - 317

* can be used only in bulkhead mounting housing

refer to CN.19 pages

bulkhead mounting housings with 2 levers



FROM SEPTEMBER 2022

surface mounting housings with 2 levers



FROM SEPTEMBER 2022

description	part No.	entry M
with levers	CLI 10	
with levers	MLP 10.20	20
with levers	MLP 10.220	20 x 2
with levers, high construction	MLAP 10.25	25
with levers, high construction	MLAP 10.225	25 x 2
with levers, high construction	MLAP 10.32	32
with levers, high construction	MLAP 10.232	32 x 2
with levers, high construction	MLAP 10.40	40
with levers, high construction	MLAP 10.240	40 x 2

panel cut-out for bulkhead mounting housings

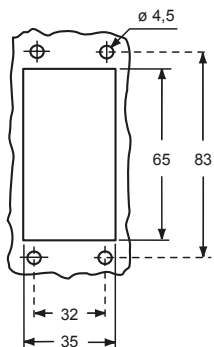

IMPORTANT NOTE: The enclosures ensure IP66/IP69 degree of protection (or IP65 for hinged cover versions) when mated and locked with the closing levers.

CLI 10 ▲

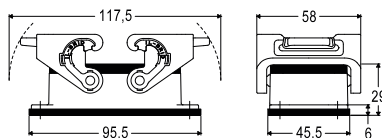

MLP 10.220

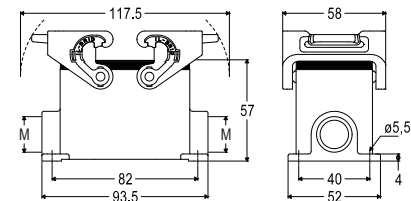

MLAP 10.225

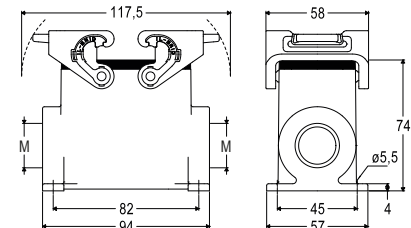

cURus
Type 4/4X/12 pending

 insulating cable gland or fittings without gasket

 cable gland with O-Ring gasket

ML – MLA Standard version with IL-BRID levers

inserts		page:
CDD	42 poles + ⊕	78
CDS	18 poles + ⊕	-
CDSH	18 poles + ⊕	87
CNE	10 poles + ⊕	111
CSE	10 poles + ⊕	-
CSH	10 poles + ⊕	111
CSH S	10 poles + ⊕	123
CCE	10 poles + ⊕	131
CMSH	3+2 (aux) poles + ⊕	136
CMCE	3+2 (aux) poles + ⊕	137
CSS	10 poles + ⊕	149
CQE	18 poles + ⊕	169
CX	8/24 poles + ⊕	194
MIXO	3 modules	262 - 317

refer to CN.19 pages

hoods with 2 levers



FROM SEPTEMBER 2022

hoods with 2 lever

M40 cable entry with 20 mm thread length



FROM SEPTEMBER 2022

description	part No.	entry M	part No.	entry M
with levers, top entry	MLV 10 G25	25		
with levers, top entry, high construction	MLAV 10 G25	25		
with levers, top entry, high construction	MLAV 10 G32	32		
with levers, top entry, high construction	MLAV 10 G40	40		
with levers, side entry, high construction, without adapter ¹⁾			MLFO 10 G40	40
with levers, top entry, high construction, without adapter ¹⁾	MLFV 10 G25	25		
with levers, top entry, high construction, without adapter ¹⁾	MLFV 10 G32	32		
with levers, top entry, high construction, without adapter ¹⁾	MLFV 10 G40	40		

¹⁾ enclosure without adapter, threaded on the body, to be used only with a complete cable gland.

MLV 10 G

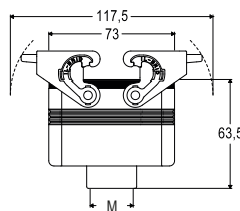

MLAV 10 G

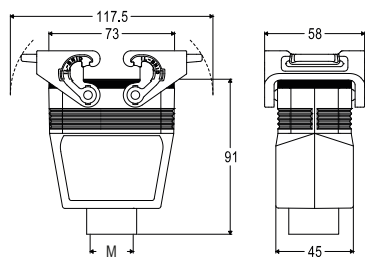

MLFV 10 G

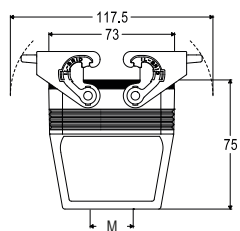

MLFO 10 G

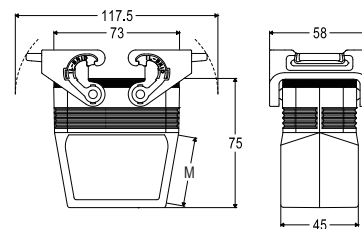

cURus
Type 4/4X/12 pending

insulating cable gland or fittings without gasket

cable gland with O-Ring gasket

CL - ML Standard version with IL-BRID levers

inserts		page:
CD	40 poles + ⊕	70
CDD	72 poles + ⊕	79
CDS	27 poles + ⊕	-
CDSH	27 poles + ⊕	88
CNE	16 poles + ⊕	112
CSE	16 poles + ⊕	-
CSH	16 poles + ⊕	112
CSH S	16 poles + ⊕	124
CCE	16 poles + ⊕	132
CMSH, CMCE	6+2 (aux) poles + ⊕	138 - 139
CSS	16 poles + ⊕	150
CT, CTS (10A)*	40 poles + ⊕	156
CT, CTSE (16A)*	16 poles + ⊕	162
CQE	32 poles + ⊕	170
CQEE	40 poles + ⊕	176
CP	6 poles + ⊕	178
CX	6/12, 6/36 and 12/2 poles + ⊕	197 - 199
CX	4/0 and 4/2 poles + ⊕	200 - 201
MIXO	4 modules	262 - 317

* can be used only in bulkhead mounting housings

refer to CN.19 pages

bulkhead mounting housings with 2 levers



FROM SEPTEMBER 2022

surface mounting housings with 2 levers



FROM SEPTEMBER 2022

description	part No.	entry M
with levers	CLI 16	
with levers	MLP 16.25	25
with levers	MLP 16.225	25 x 2
with levers, high construction	MLAP 16.25	25
with levers, high construction	MLAP 16.225	25 x 2
with levers, high construction	MLAP 16.32	32
with levers, high construction	MLAP 16.232	32 x 2
with levers, high construction	MLAP 16.40	40
with levers, high construction	MLAP 16.240	40 x 2

panel cut-out for bulkhead mounting housings

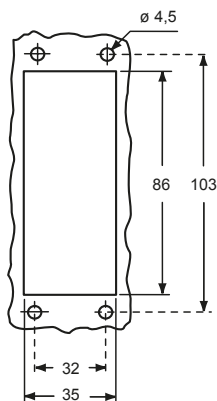

IMPORTANT NOTE: The enclosures ensure IP66/IP69 degree of protection (or IP65 for hinged cover versions) when mated and locked with the closing levers.

CLI 16 ▲

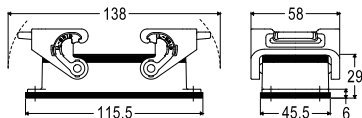

MLP 16

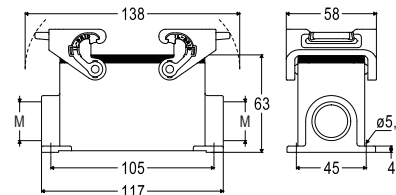

MLAP 16

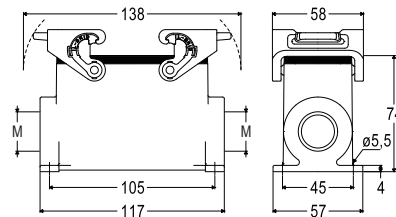

cURus
Type 4/4X/12 pending

 insulating cable gland or fittings without gasket

 cable gland with O-Ring gasket

ML – MLA Standard version with IL-BRID levers

inserts		page:
CD	40 poles + ⊕	70
CDD	72 poles + ⊕	79
CDS	27 poles + ⊕	-
CDSH	27 poles + ⊕	88
CNE	16 poles + ⊕	112
CSE	16 poles + ⊕	-
CSH	16 poles + ⊕	112
CSH S	16 poles + ⊕	124
CCE	16 poles + ⊕	132
CMSH, CMCE	6+2 (aux) poles + ⊕	138 - 139
CSS	16 poles + ⊕	150
CQE	32 poles + ⊕	170
CQEE	40 poles + ⊕	176
CP	6 poles + ⊕	178
CX	6/12, 6/36 and 12/2 poles + ⊕	197 - 199
CX	4/0 and 4/2 poles + ⊕	200 - 201
MIXO	4 modules	262 - 317

refer to CN.19 pages

hoods with 2 levers



FROM SEPTEMBER 2022

hoods with 2 lever

M40 cable entry with 20 mm thread length



FROM SEPTEMBER 2022

description	part No.	entry M	part No.	entry M
with levers, top entry	MLV 16 G32	32		
with levers, top entry, high construction	MLAV 16 G25	25		
with levers, top entry, high construction	MLAV 16 G32	32		
with levers, top entry, high construction	MLAV 16 G40	40		
with levers, side entry, high construction, without adapter ¹⁾			MLFO 16 G40	40
with levers, top entry, high construction, without adapter ¹⁾	MLFV 16 G25	25		
with levers, top entry, high construction, without adapter ¹⁾	MLFV 16 G32	32		
with levers, top entry, high construction, without adapter ¹⁾	MLFV 16 G40	40		

¹⁾ enclosure without adapter, threaded on the body, to be used only with a complete cable gland.

MLV 16 G

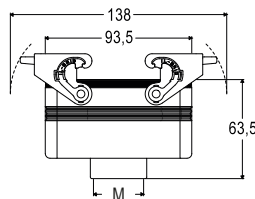

MLAV 16 G

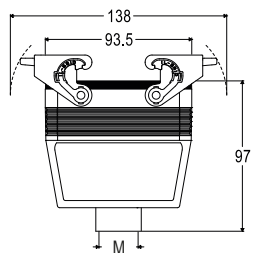

MLFV 16 G

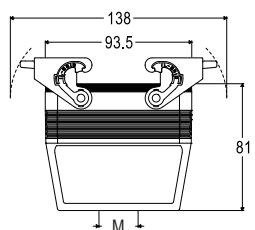

MLFO 16 G

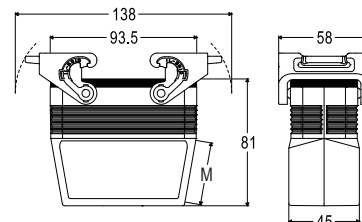

cURus
Type 4/4X/12 pending

insulating cable gland or fittings without gasket

cable gland with O-Ring gasket

CL - ML Standard version with IL-BRID levers

inserts		page:
CD	64 poles + ⊕	72
CDD	108 poles + ⊕	81
CDS	42 poles + ⊕	-
CDSH	42 poles + ⊕	89
CNE	24 poles + ⊕	113
CSE	24 poles + ⊕	-
CSH	24 poles + ⊕	113
CSH S	24 poles + ⊕	125
CCE	24 poles + ⊕	133
CMSH	10+2 (aux) poles + ⊕	140
CMCE	10+2 (aux) poles + ⊕	141
CSS	24 poles + ⊕	151
CT, CTS (10A)*	64 poles + ⊕	157
CT, CTSE (16A)*	24 poles + ⊕	163
CQE	46 poles + ⊕	171
CQEE	64 poles + ⊕	177
CX	4/8 and 6/6 poles + ⊕	204 and 206
MIXO	6 modules	262 - 317

* can be used only in bulkhead mounting housings

refer to CN.19 pages

bulkhead mounting housings with 2 levers



FROM SEPTEMBER 2022

surface mounting housings with 2 levers



FROM SEPTEMBER 2022

description	part No.	entry M
with levers	CLI 24	
with levers	MLP 24.25	25
with levers	MLP 24.225	25 x 2
with levers, high construction	MLAP 24.25	25
with levers, high construction	MLAP 24.225	25 x 2
with levers, high construction	MLAP 24.32	32
with levers, high construction	MLAP 24.232	32 x 2
with levers, high construction	MLAP 24.40	40
with levers, high construction	MLAP 24.240	40 x 2

panel cut-out for bulkhead mounting housings

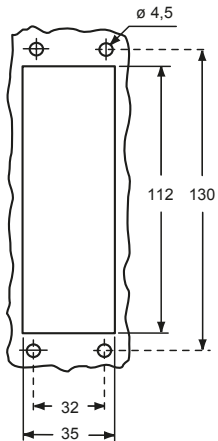

IMPORTANT NOTE: The enclosures ensure IP66/IP69 degree of protection (or IP65 for hinged cover versions) when mated and locked with the closing levers.

cURus
Type 4/4X/12 pending

 insulating cable gland or fittings without gasket

 cable gland with O-Ring gasket

CLI 24 ▲

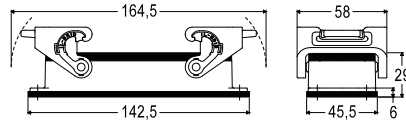

MLP 24

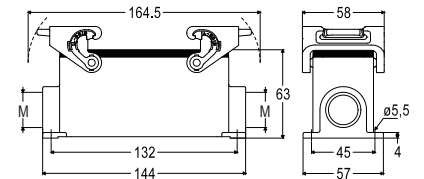

MLAP 24

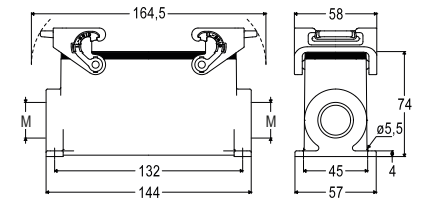

ML – MLA Standard version with IL-BRID levers

inserts		page:
CD	64 poles + ⊕	72
CDD	108 poles + ⊕	81
CDS	42 poles + ⊕	-
CDSH	42 poles + ⊕	89
CNE	24 poles + ⊕	113
CSE	24 poles + ⊕	-
CSH	24 poles + ⊕	113
CSH S	24 poles + ⊕	125
CCE	24 poles + ⊕	133
CMSH	10+2 (aux) poles + ⊕	140
CMCE	10+2 (aux) poles + ⊕	141
CSS	24 poles + ⊕	151
CQE	46 poles + ⊕	171
CQEE	64 poles + ⊕	177
CX	4/8 and 6/6 poles + ⊕	204 and 206
MIXO	6 modules	262 - 317

refer to CN.19 pages

hoods with 2 levers



FROM SEPTEMBER 2022

hoods with 2 lever

M40 cable entry with 20 mm thread length



FROM SEPTEMBER 2022

description	part No.	entry M	part No.	entry M
with levers, top entry	MLV 24 G32	32		
with levers, top entry, high construction	MLAV 24 G25	25		
with levers, top entry, high construction	MLAV 24 G32	32		
with levers, top entry, high construction	MLAV 24 G40	40		
with levers, side entry, high construction, without adapter ¹⁾			MLFO 24 G40	40
with levers, top entry, high construction, without adapter ¹⁾	MLFV 24 G25	25		
with levers, top entry, high construction, without adapter ¹⁾	MLFV 24 G32	32		
with levers, top entry, high construction, without adapter ¹⁾	MLFV 24 G40	40		

¹⁾ enclosure without adapter, threaded on the body, to be used only with a complete cable gland.

MLV 24 G

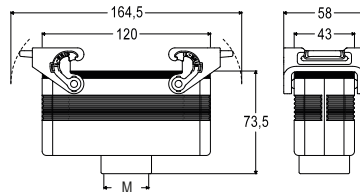

MLAV 24 G

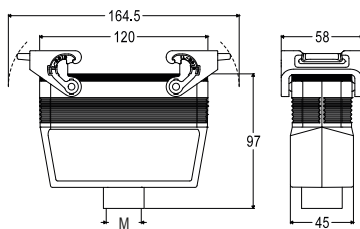

MLFV 24 G

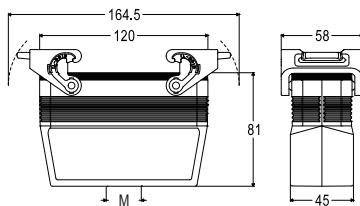

MLFO 24 G

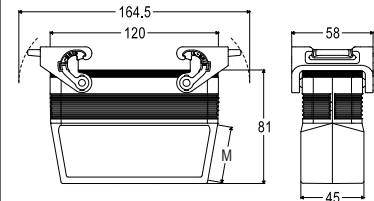

cURus
Type 4/4X/12 pending



insulating cable gland or fittings
without gasket



cable gland
with O-Ring gasket

T-TYPE HYGIENIC

New, improved design for smoother locking levers and cleanproof logo



Safety, detectability
and cleaning for food
contamination prevention



Find out more
www.ilme.com

TECHNICAL FEATURES



Watch our
technical clip

The **T-TYPE HYGIENIC** series (T-TYPE /H and T-TYPE /C) enclosures have been **improved** in their design to enhance their cleanability, thus reducing the likeliness of providing seat for dirt.

This has been achieved by a overhaul design of their locking levers, keeping its **sturdiness** and impeccable **locking function**, still made with blue coloured thermoplastic insulating material qualified for contact with food and resistant to the most popular cleaning agents, now also **metal-detectable**, in the remote event - frankly quite unlikely - of loss of parts of said levers in the food.

The **new design** of the T-TYPE HYGIENIC locking levers is characterized by:

- Q a “family air” shared with the new IL-BRID locking levers for standard metallic connector enclosures (see previous pages);
- Q the **smoothing** of any recess;

- Q the **remodelling** of any part possibly retaining dirt;
- Q the keeping of utmost **ergonomics**;
- Q the achieving of significant **reduction** in footprint, during movement, particularly on the angles.

Additionally, the ILME-stripped logo, signature trait of the T-TYPE series hoods, has become a **smoothed, only slightly high relief and clean proof sign**, guaranteeing an even more cleanable surface compared to the previous bas-relief version.

The ILME logo improvement regards all T-TYPE variants, including the standard type and the T-TYPE /W, all sharing the same hoods. **Part numbers remain unchanged.** Zip code will be announced by a dedicated Product Info (also for standard T-TYPE and T-TYPE /W).

In addition to the models described in detail in the following pages, all **surface mounting housings with both M cable entries opened** and all hoods and **housings with preassembled CR ... BPE protective earth jumpers** are available. See [Table below](#) for all part Nos.

Variants with preassembled **CR ... BPE** protective earth jumpers are available for **all series T-TYPE** hoods and housings, **including also standard types and T-TYPE /W**. Their part number is the same of base model plus **letter B** at the end, as shown – for T-TYPE HYGIENIC models only – in the table below.

Size	Cable outlet	Locking lever	T-TYPE HYGIENIC /H		T-TYPE HYGIENIC Cold /C	
			part No.	part No.*	part No.	part No.*
44.27	-	single	THIH 06 L	THIH 06 LB	THIC 06 L	THIC 06 LB
57.27	-	double	THIH 10	THIH 10 B	THIC 10	THIC 10 B
77.27	-		THIH 16	THIH 16 B	THIC 16	THIC 16 B
104.27	-		THIH 24	THIH 24 B	THIC 24	THIC 24 B
44.27	M25	single	TAPH 06 L25	TAPH 06L25B	TAPC 06 L25	TAPC 06L25B
	M32		TAPH 06 L32	TAPH 06L32B	TAPC 06 L32	TAPC 06L32B
	2xM25		TAPH 06 L225	TAPH06L225B	TAPC 06 L225	TAPC06L225B
	2xM32		TAPH 06 L232	TAPH06L232B	TAPC 06 L232	TAPC06L232B
57.27	M25	double	TAPH 10.25	TAPH 10.25B	TAPC 10.25	TAPC 10.25B
	M32		TAPH 10.32	TAPH 10.32B	TAPC 10.32	TAPC 10.32B
	2xM25		TAPH 10.225	TAPH10.225B	TAPC 10.225	TAPC10.225B
	2xM32		TAPH 10.232	TAPH10.232B	TAPC 10.232	TAPC10.232B
77.27	M32	double	TAPH 16.32	TAPH 16.32B	TAPC 16.32	TAPC 16.32B
	M40		TAPH 16.40	TAPH 16.40B	TAPC 16.40	TAPC 16.40B
	2xM32		TAPH 16.232	TAPH16.232B	TAPC 16.232	TAPC16.232B
	2xM40		TAPH 16.240	TAPH16.240B	TAPC 16.240	TAPC16.240B
104.27	M32	double	TAPH 24.32	TAPH 24.32B	TAPC 24.32	TAPC 24.32B
	M40		TAPH 24.40	TAPH 24.40B	TAPC 24.40	TAPC 24.40B
	2xM32		TAPH 24.232	TAPH24.232B	TAPC 24.232	TAPC24.232B
	2xM40		TAPH 24.240	TAPH24.240B	TAPC 24.240	TAPC24.240B
44.27	M25	single	TAVH 06 LG25	TAVH06LG25B	TAVC 06 LG25	TAVC06LG25B
	M32		TAVH 06 LG32	TAVH06LG32B	TAVC 06 LG32	TAVC06LG32B
57.27	M25	double	TAVH 10 G25	TAVH 10G25B	TAVC 10 G25	TAVC 10G25B
	M32		TAVH 10 G32	TAVH 10G32B	TAVC 10 G32	TAVC 10G32B
77.27	M32		TAVH 16 G32	TAVH 16G32B	TAVC 16 G32	TAVC 16G32B
	M40		TAVH 16 G40	TAVH 16G40B	TAVC 16 G40	TAVC 16G40B
104.27	M32	double	TAVH 24 G32	TAVH 24G32B	TAVC 24 G32	TAVC 24G32B
	M40		TAVH 24 G40	TAVH 24G40B	TAVC 24 G40	TAVC 24G40B

* Enclosures with protective earth jumpers CR...BPE preassembled with part No. of base model plus **letter B** at the end.

Size	With loop	Locking lever	Covers for T-TYPE HYGIENIC	Covers for T-TYPE HYGIENIC Cold
			part No.	part No.
44.27		single	THCH 06 LG	THCC 06 LG
57.27		double	THCH 10 G	THCC 10 G
77.27			THCH 16 G	THCC 16 G
104.27			THCH 24 G	THCC 24 G

T-TYPE / H for production lines HYGIENIC SERIES

inserts		page:
CDD	24 poles + ⊕	76
CDS	9 poles + ⊕	-
CDSH	9 poles + ⊕	86
CDSH NC	6 poles + ⊕	95
CNE	6 poles + ⊕	110
CSE	6 poles + ⊕	-
CSH	6 poles + ⊕	110
CSH S	6 poles + ⊕	122
CCE	6 poles + ⊕	130
CSS	6 poles + ⊕	148
CT, CTSE (16 A)*	6 poles + ⊕	160
CQE	10 poles + ⊕	168
MIXO	2 modules	262 - 317

* only for standard insulating version THIH

refer to CN.19 pages

housings with single lever HNBR gasket

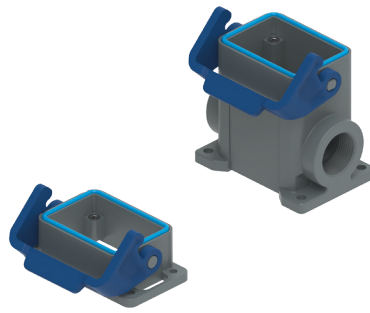

FROM JULY 2022

hoods with 2 pegs



FROM JULY 2022

description	part No.	entry M	part No.	entry M
bulkhead mounting housing with thermoplastic lever	THIH 06 L			
surface mounting housing with thermoplastic lever, high construction	TAPH 06 L25	25		
surface mounting housing with thermoplastic lever, high construction	TAPH 06 L32	32		
with pegs, side entry, high construction			TMAO 06 L25	25
with pegs, side entry, high construction			TMAO 06 L32	32
with pegs, top entry, high construction			TMAV 06 L25	25
with pegs, top entry, high construction			TMAV 06 L32	32

panel cut-out for bulkhead mounting housings

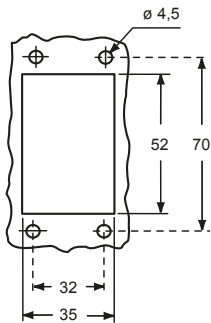

THIH L

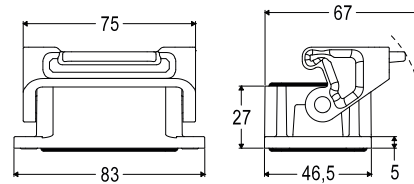

TAPH L

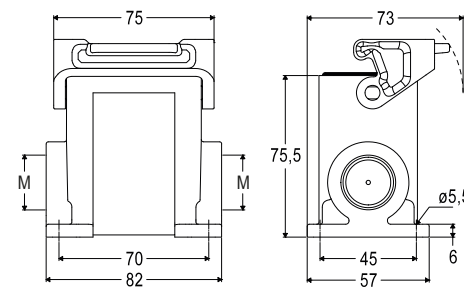

TMAO L

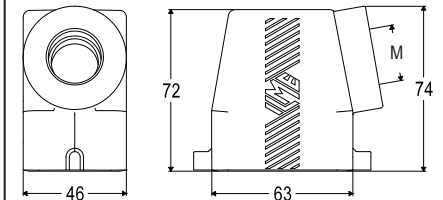

TMAV L

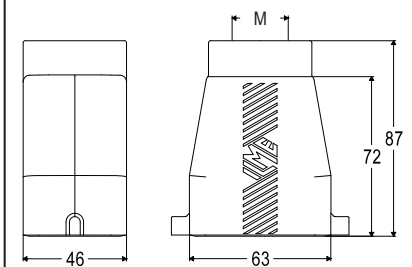

(*) The surface mounting, high construction housings are supplied with an open threaded entry (→) and diametrically opposite a closed threaded entry which can be opened by the user if required (with suitable tool).

cURus
Type 12 pending



ambient temperature limits -40 °C / +70 °C

T-TYPE / H for production lines HYGIENIC SERIES

inserts		page:
CDD	24 poles + ⊕	76
CDS	9 poles + ⊕	-
CDSH	9 poles + ⊕	86
CDSH NC	6 poles + ⊕	95
CNE	6 poles + ⊕	110
CSE	6 poles + ⊕	-
CSH	6 poles + ⊕	110
CSH S	6 poles + ⊕	122
CCE	6 poles + ⊕	130
CSS	6 poles + ⊕	148
CT, CTSE (16 A)*	6 poles + ⊕	160
CQE	10 poles + ⊕	168
MIXO	2 modules	262 - 317

* only for standard insulating version TCHC

refer to CN.19 pages

hoods with single lever top entry, HNBR gasket



FROM JULY 2022

covers HNBR gasket

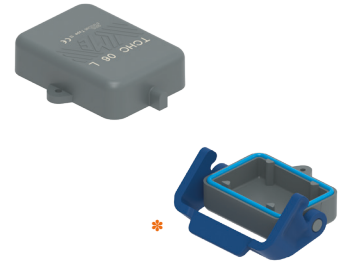

FROM JULY 2022*

description	part No.	entry M	part No. (with eyelet)	part No. (with loop)
with thermoplastic lever and gasket, high construction	TAVH 06 LG25	25		
with thermoplastic lever and gasket, high construction with pegs	TAVH 06 LG32	32		
with thermoplastic lever and gasket			TCHC 06 L	TCHC 06 SL
				THCH 06 LG *

TAVH LG

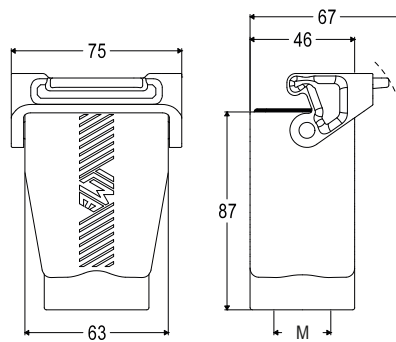

TCHC L (SL)

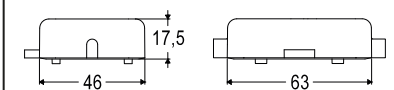

THCH LG

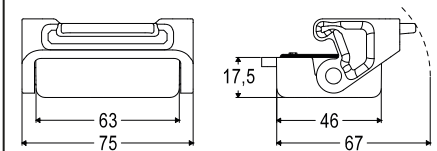

For fixing on housings

eyelet

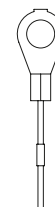

For fixing on hoods

loop

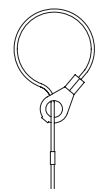

cURus
Type 12 pending



ambient temperature limits -40 °C / +70 °C

T-TYPE / H for production lines HYGIENIC SERIES

inserts

CDD	42 poles + ⊕	78
CDS	18 poles + ⊕	-
CDSH	18 poles + ⊕	87
CNE	10 poles + ⊕	111
CSE	10 poles + ⊕	-
CSH	10 poles + ⊕	111
CSH S	10 poles + ⊕	123
CCE	10 poles + ⊕	131
CMSH	3+2 (aux) poles + ⊕	136
CMCE	3+2 (aux) poles + ⊕	137
CSS	10 poles + ⊕	149
CT, CTSE (16 A)*	10 poles + ⊕	161
CQE	18 poles + ⊕	169
CX	8/24 poles + ⊕	194
MIXO	3 modules	262 - 317

* only for standard insulating version THIH

refer to CN.19 pages

page:

**housings with 2 levers
HNBR gasket**

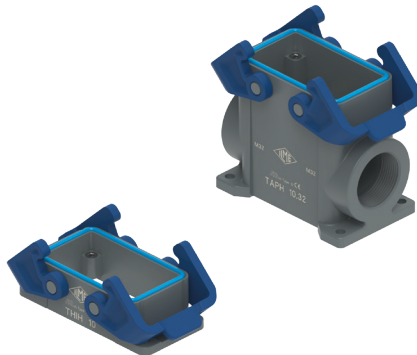

FROM JULY 2022

hoods with 4 pegs



FROM JULY 2022

description	part No.	entry M	part No.	entry M
bulkhead mounting housing with thermoplastic levers	THIH 10			
surface mounting housing, thermoplastic levers, high construction	TAPH 10.25	25	TMAO 10.25	25
surface mounting housing, thermoplastic levers, high construction	TAPH 10.32	32	TMAO 10.32	32
with pegs, side entry, high construction			TMAV 10.25	25
with pegs, side entry, high construction			TMAV 10.32	32
with pegs, top entry, high construction				
with pegs, top entry, high construction				

panel cut-out for bulkhead mounting housings

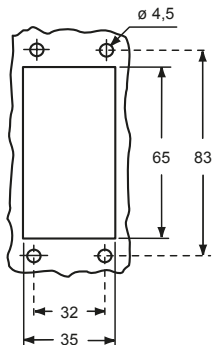

THIH

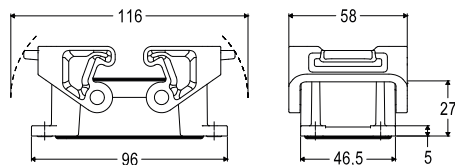

TAPH

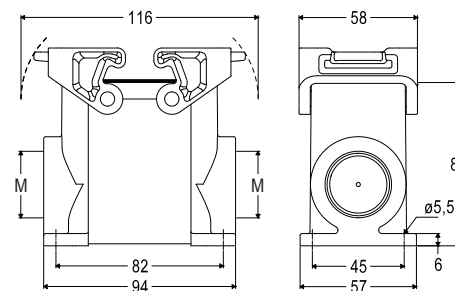

TMAO

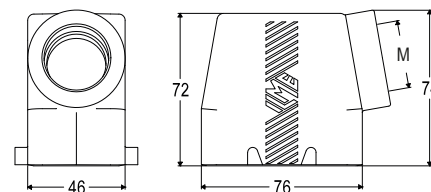

TMAV

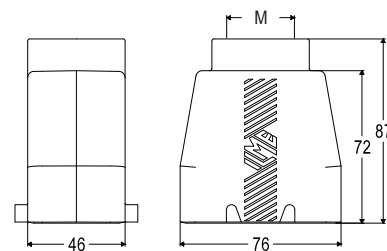

The surface mounting, high construction housings are supplied with an open threaded entry and diametrically opposite a closed threaded entry which can be opened by the user if required (with suitable tool).

cURus
Type 12 pending



ambient temperature limits -40 °C / +70 °C

T-TYPE / H for production lines HYGIENIC SERIES

inserts		page:
CDD	42 poles + ⊕	78
CDS	18 poles + ⊕	-
CDSH	18 poles + ⊕	87
CNE	10 poles + ⊕	111
CSE	10 poles + ⊕	-
CSH	10 poles + ⊕	111
CSH S	10 poles + ⊕	123
CCE	10 poles + ⊕	131
CMSH	3+2 (aux) poles + ⊕	136
CMCE	3+2 (aux) poles + ⊕	137
CSS	10 poles + ⊕	149
CT, CTSE (16 A)*	10 poles + ⊕	161
CQE	18 poles + ⊕	169
CX	8/24 poles + ⊕	194
MIXO	3 modules	262 - 317

* only for standard insulating version TCHC

refer to CN.19 pages

hoods with 2 levers top entry, HNBR gasket



FROM JULY 2022

covers HNBR gasket

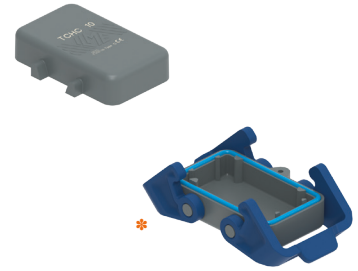

FROM JULY 2022*

description	part No.	entry M	part No. (with eyelet)	part No. (with loop)
with thermoplastic levers and gasket, high construction	TAVH 10 G25	25	TCHC 10	TCHC 10 S
with thermoplastic levers and gasket, high construction with 4 pegs	TAVH 10 G32	32		THCH 10 G *
with 2 thermoplastic levers and gasket				

TAVH G

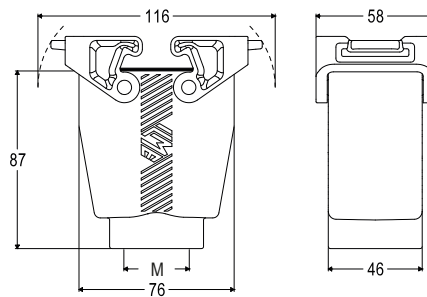

TCHC (S)

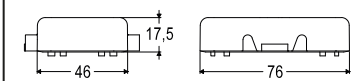

THCH G

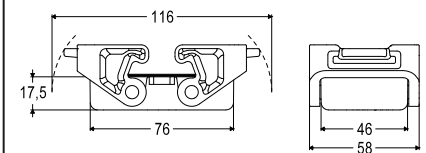

cURus
Type 12 pending



ambient temperature limits -40 °C / +70 °C

For fixing
on housings

eyelet

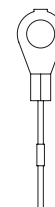

For fixing
on hoods

loop

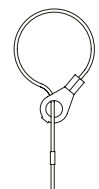

T-TYPE / H for production lines HYGIENIC SERIES

inserts

CD	40 poles + ⊕	70
CDD	72 poles + ⊕	79
CDS	27 poles + ⊕	-
CDSH	27 poles + ⊕	88
CNE	16 poles + ⊕	112
CSE	16 poles + ⊕	-
CSH	16 poles + ⊕	112
CSH S	16 poles + ⊕	124
CCE	16 poles + ⊕	132
CM SH, CMCE	6+2 (aux) poles + ⊕	138 - 139
CSS	16 poles + ⊕	150
CT, CTSE (16 A)*	16 poles + ⊕	162
CQE	32 poles + ⊕	170
CQEE	40 poles + ⊕	176
CP	6 poles + ⊕	178
CX	6/12, 6/36 and 12/2 poles + ⊕	197 - 199
CX	4/0 and 4/2 poles + ⊕	200 - 201

* only for standard insulating version THIH

refer to CN.19 pages

page:

**housings with 2 levers
HNBR gasket**

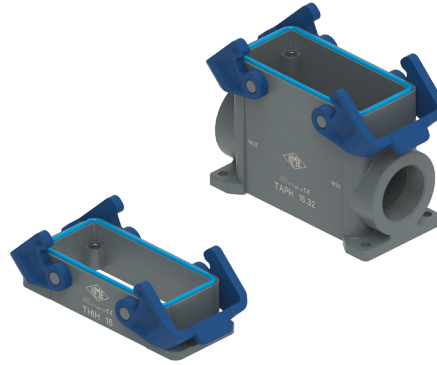

FROM JULY 2022

hoods with 4 pegs



FROM JULY 2022

description	part No.	entry M	part No.	entry M
bulkhead mounting housing with thermoplastic levers	THIH 16			
surface mounting housing, thermoplastic levers, high construction	TAPH 16.32	32		
surface mounting housing, thermoplastic levers, high construction	TAPH 16.40	40		
with pegs, side entry, high construction			TMAO 16.32	32
with pegs, side entry, high construction			TMAO 16.40	40
with pegs, top entry, high construction			TMAV 16.32	32
with pegs, top entry, high construction			TMAV 16.40	40

panel cut-out for bulkhead mounting housings

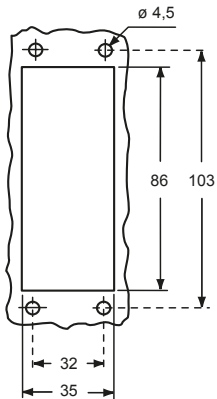

THIH

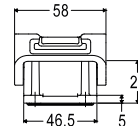
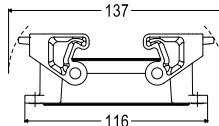

TAPH

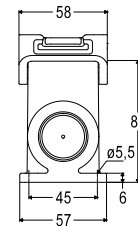
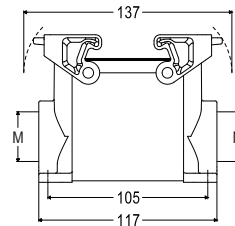

TMAO

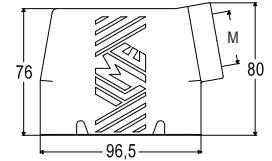
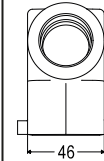

TMAV

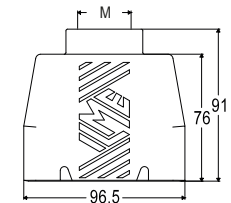
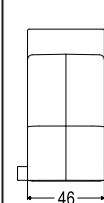

The surface mounting, high construction housings are supplied with an open threaded entry and diametrically opposite a closed threaded entry which can be opened by the user if required (with suitable tool).

cURus
Type 12 pending



ambient temperature limits -40 °C / +70 °C

T-TYPE / H for production lines HYGIENIC SERIES

inserts		page:
CD	40 poles + ⊕	70
CDD	72 poles + ⊕	79
CDS	27 poles + ⊕	-
CDSH	27 poles + ⊕	88
CNE	16 poles + ⊕	112
CSE	16 poles + ⊕	-
CSH	16 poles + ⊕	112
CSH S	16 poles + ⊕	124
CCE	16 poles + ⊕	132
CMSH, CMCE	6+2 (aux) poles + ⊕	138 - 139
CSS	16 poles + ⊕	150
CT, CTSE (16 A)*	16 poles + ⊕	162
CQE	32 poles + ⊕	170
CQEE	40 poles + ⊕	176
CP	6 poles + ⊕	178
CX	6/12, 6/36 and 12/2 poles + ⊕	197 - 199
CX	4/0 and 4/2 poles + ⊕	200 - 201

* only for standard insulating version TCHc

refer to CN.19 pages

hoods with 2 levers top entry, HNBR gasket



FROM JULY 2022

covers HNBR gasket

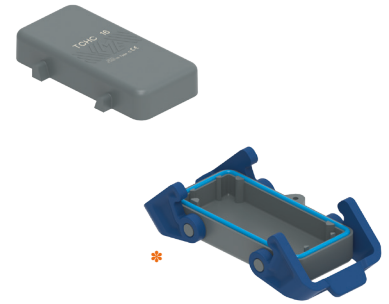

FROM JULY 2022*

description	part No.	entry M	part No. (with eyelet)	part No. (with loop)
with thermoplastic levers and gasket, high construction	TAVH 16 G32	32		
with thermoplastic levers and gasket, high construction	TAVH 16 G40	40		
with 4 pegs			TCHC 16	TCHC 16 S
with 2 thermoplastic levers and gasket				THCH 16 G *

TAVH G

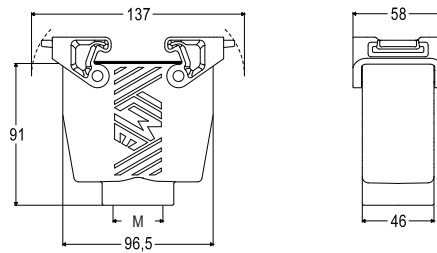

TCHC (S)

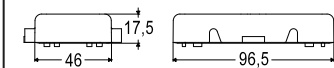

THCH G

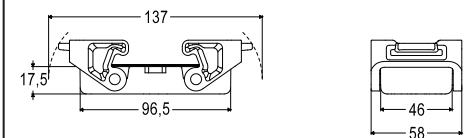

cURus
Type 12 pending



ambient temperature limits -40 °C / +70 °C

For fixing
on housings

eyelet

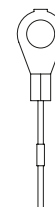

For fixing
on hoods

loop

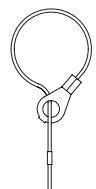

T-TYPE / H for production lines HYGIENIC SERIES

inserts

CD	64 poles + ⊕	72
CDD	108 poles + ⊕	81
CDS	42 poles + ⊕	-
CDSH	42 poles + ⊕	89
CNE	24 poles + ⊕	113
CSE	24 poles + ⊕	-
CSH	24 poles + ⊕	113
CSH S	24 poles + ⊕	125
CCE	24 poles + ⊕	133
CMSH	10+2 (aux) poles + ⊕	140
CMCE	10+2 (aux) poles + ⊕	141
CSS	24 poles + ⊕	151
CT, CTSE (16 A)*	24 poles + ⊕	163
CQE	46 poles + ⊕	171
CQEE	64 poles + ⊕	177
CX	4/8 and 6/6 poles + ⊕	204, 206
MIXO	6 modules	262 - 317

* only for standard insulating version THIH

refer to CN.19 pages

page:

**housings with 2 levers
HNBR gasket**

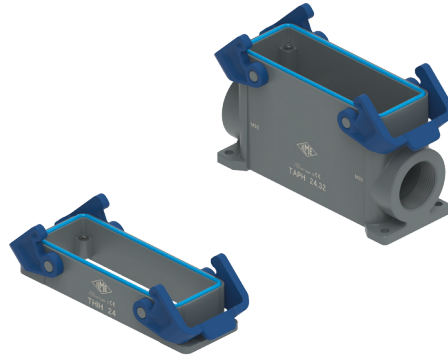

FROM JULY 2022

hoods with 4 pegs



FROM JULY 2022

description	part No.	entry M	part No.	entry M
bulkhead mounting housing with thermoplastic levers	THIH 24			
surface mounting housing, thermoplastic levers, high construction	TAPH 24.32	32		
surface mounting housing, thermoplastic levers, high construction	TAPH 24.40	40		
with pegs, side entry, high construction			TMAO 24.32	32
with pegs, side entry, high construction			TMAO 24.40	40
with pegs, top entry, high construction			TMAV 24.32	32
with pegs, top entry, high construction			TMAV 24.40	40

panel cut-out for bulkhead mounting housings

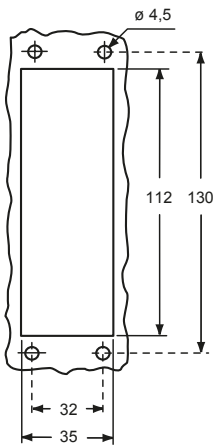

THIH

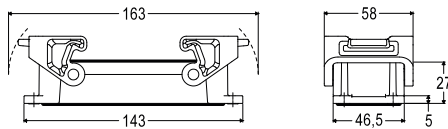

TAPH

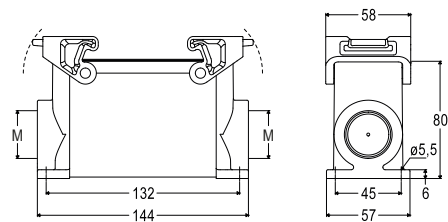

TMAO

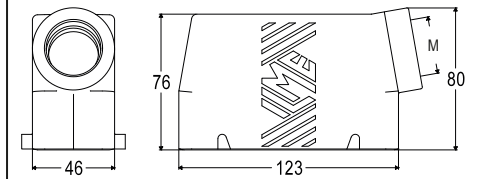

TMAV

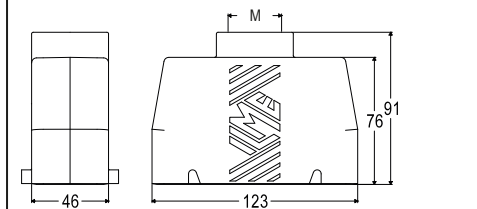

The surface mounting, high construction housings are supplied with an open threaded entry and diametrically opposite a closed threaded entry which can be opened by the user if required (with suitable tool).

cURus
Type 12 pending



ambient temperature limits -40 °C / +70 °C

T-TYPE / H for production lines HYGIENIC SERIES

inserts		page:
CD	64 poles + ⊕	72
CDD	108 poles + ⊕	81
CDS	42 poles + ⊕	-
CDSH	42 poles + ⊕	89
CNE	24 poles + ⊕	113
CSE	24 poles + ⊕	-
CSH	24 poles + ⊕	113
CSH S	24 poles + ⊕	125
CCE	24 poles + ⊕	133
CMSH	10+2 (aux) poles + ⊕	140
CMCE	10+2 (aux) poles + ⊕	141
CSS	24 poles + ⊕	151
CT, CTSE (16 A)*	24 poles + ⊕	163
CQE	46 poles + ⊕	171
CQEE	64 poles + ⊕	177
CX	4/8 and 6/6 poles + ⊕	204, 206
MIXO	6 modules	262 - 317

* only for standard insulating version TCHC

refer to CN.19 pages

hoods with 2 levers top entry, HNBR gasket



FROM JULY 2022

covers HNBR gasket

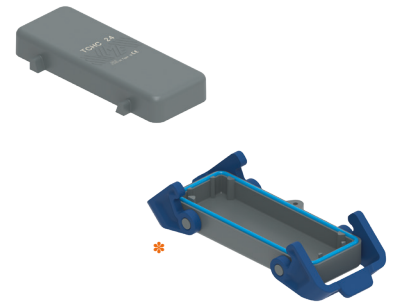

FROM JULY 2022*

description	part No.	entry M	part No. (with eyelet)	part No. (with loop)
with thermoplastic levers and gasket, high construction	TAVH 24 G32	32		
with thermoplastic levers and gasket, high construction with 4 pegs	TAVH 24 G40	40		
with 2 thermoplastic levers and gasket			TCHC 24	TCHC 24 S
				THCH 24 G *

TAVH G

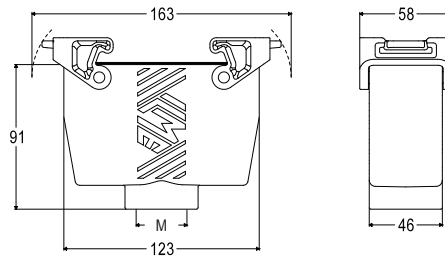

TCHC (S)

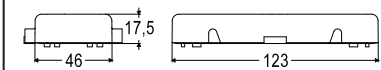

THCH G

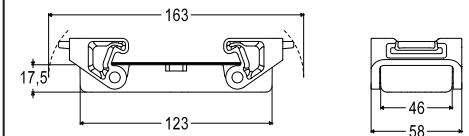

For fixing on housings

eyelet

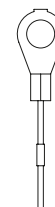

For fixing on hoods

loop

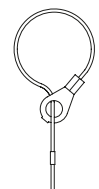

cURus
Type 12 pending



ambient temperature limits -40 °C / +70 °C

T-TYPE / C for low-temperature HYGIENIC SERIES

inserts

CDD	24 poles + ⊕	76
CDS	9 poles + ⊕	-
CDSH	9 poles + ⊕	86
CDSH NC	6 poles + ⊕	95
CNE	6 poles + ⊕	110
CSE	6 poles + ⊕	-
CSH	6 poles + ⊕	110
CSH S	6 poles + ⊕	122
CCE	6 poles + ⊕	130
CSS	6 poles + ⊕	148
CT, CTSE (16 A)*	6 poles + ⊕	160
CQE	10 poles + ⊕	168
MIXO	2 modules	262 - 317

* only for standard insulating version THIH

refer to CN.19 pages

page:

**housings with 2 levers
 SILICONE gasket**

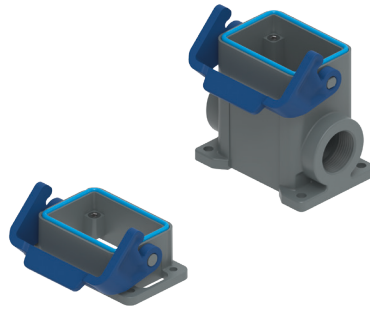

FROM JULY 2022

hoods with 4 pegs



FROM JULY 2022

description	part No.	entry M	part No.	entry M
bulkhead mounting housing with thermoplastic lever	THIC 06 L			
surface mounting housing with thermoplastic lever, high construction	TAPC 06 L25	25		
surface mounting housing with thermoplastic lever, high construction	TAPC 06 L32	32		
with pegs, side entry, high construction			TMAO 06 L25	25
with pegs, side entry, high construction			TMAO 06 L32	32
with pegs, top entry, high construction			TMAV 06 L25	25
with pegs, top entry, high construction			TMAV 06 L32	32

panel cut-out for bulkhead mounting housings

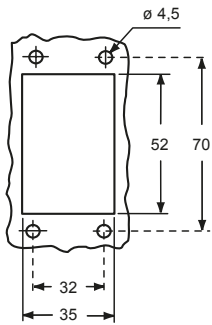

THIC L

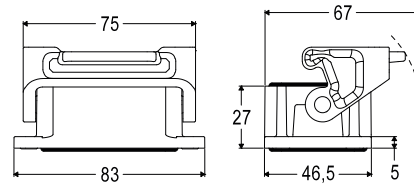

TAPC L

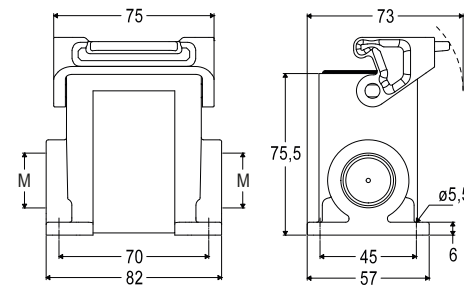

TMAO L

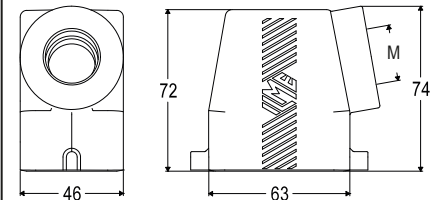

TMAV L

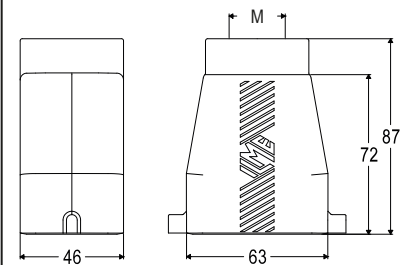

(*) The surface mounting, high construction housings are supplied with an open threaded entry (→) and diametrically opposite a closed threaded entry which can be opened by the user if required (with suitable tool).

cURus
Type 12 pending



ambient temperature limits -50 °C / +70 °C

T-TYPE / C for low-temperature **HYGIENIC SERIES**

inserts		page:
CDD	24 poles + ⊕	76
CDS	9 poles + ⊕	-
CDSH	9 poles + ⊕	86
CDSH NC	6 poles + ⊕	95
CNE	6 poles + ⊕	110
CSE	6 poles + ⊕	-
CSH	6 poles + ⊕	110
CSH S	6 poles + ⊕	122
CCE	6 poles + ⊕	130
CSS	6 poles + ⊕	148
CT, CTSE (16 A)*	6 poles + ⊕	160
CQE	10 poles + ⊕	168
MIXO	2 modules	262 - 317

* only for standard insulating version TCHC

refer to CN.19 pages

hoods with 2 levers, top entry SILICONE gasket



FROM JULY 2022

covers SILICONE gasket

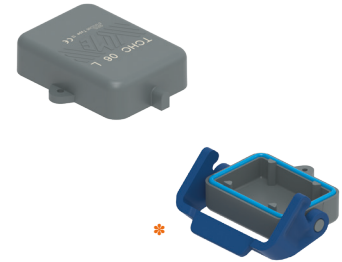

FROM JULY 2022*

description	part No.	entry M	part No. (with eyelet)	part No. (with loop)
with thermoplastic lever and gasket, high construction	TAVC 06 LG25	25		
with thermoplastic lever and gasket, high construction	TAVC 06 LG32	32		
with pegs			TCHC 06 L	TCHC 06 SL
with thermoplastic lever and gasket				THCC 06 LG *

TAVC LG

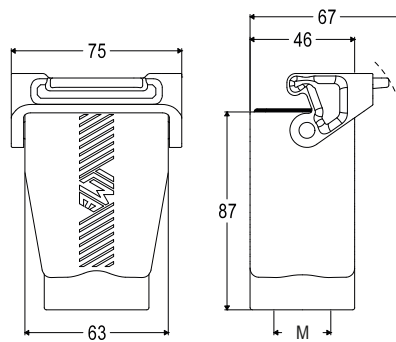

TCHC L (SL)

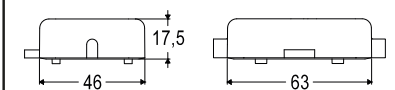

THCC LG

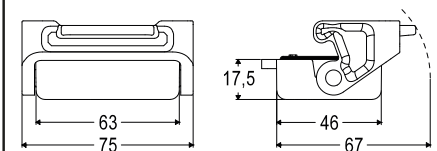

cURus
Type 12 pending



ambient temperature limits -50 °C / +70 °C

For fixing
on housings

eyelet

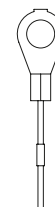

For fixing
on hoods

loop

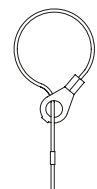

T-TYPE / C for low-temperature HYGIENIC SERIES

inserts		page:
CDD	42 poles + ⊕	78
CDS	18 poles + ⊕	-
CDSH	18 poles + ⊕	87
CNE	10 poles + ⊕	111
CSE	10 poles + ⊕	-
CSH	10 poles + ⊕	111
CSH S	10 poles + ⊕	123
CCE	10 poles + ⊕	131
CMSH	3+2 (aux) poles + ⊕	136
CMCE	3+2 (aux) poles + ⊕	137
CSS	10 poles + ⊕	149
CT, CTSE (16 A)*	10 poles + ⊕	161
CQE	18 poles + ⊕	169
CX	8/24 poles + ⊕	194
MIXO	3 modules	262 - 317

* only for standard insulating version THIH

refer to CN.19 pages

housings with 2 levers SILICONE gasket

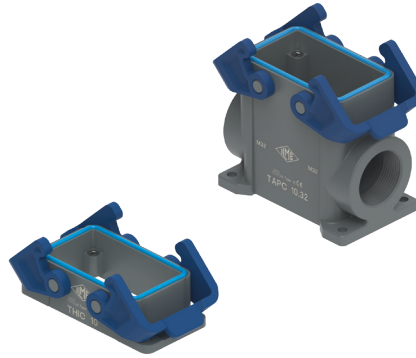

FROM JULY 2022

hoods with 4 pegs



FROM JULY 2022

description	part No.	entry M	part No.	entry M
bulkhead mounting housing with thermoplastic levers	THIC 10			
surface mounting housing, thermoplastic levers, high construction	TAPC 10.25	25		
surface mounting housing, thermoplastic levers, high construction	TAPC 10.32	32		
with pegs, side entry, high construction			TMAO 10.25	25
with pegs, side entry, high construction			TMAO 10.32	32
with pegs, top entry, high construction			TMAV 10.25	25
with pegs, top entry, high construction			TMAV 10.32	32

panel cut-out for bulkhead mounting housings

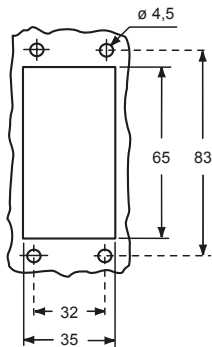

THIC

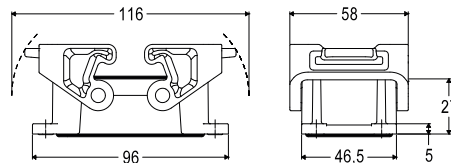

TAPC

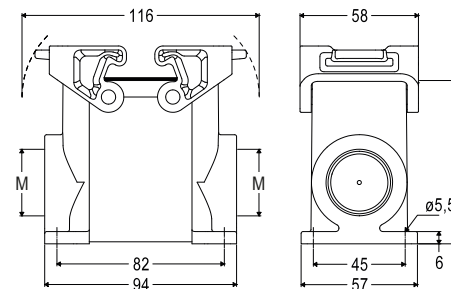

TMAO

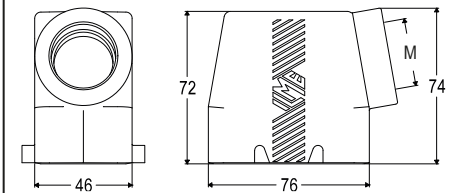

TMAV

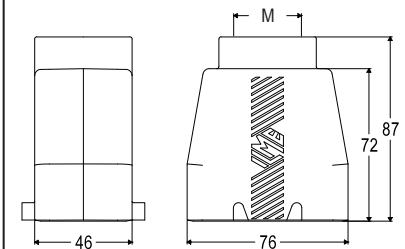

The surface mounting, high construction housings are supplied with an open threaded entry and diametrically opposite a closed threaded entry which can be opened by the user if required (with suitable tool).

cURus
Type 12 pending



ambient temperature limits -50 °C / +70 °C

T-TYPE / C for low-temperature **HYGIENIC SERIES**

inserts		page:
CDD	42 poles + ⊕	78
CDS	18 poles + ⊕	-
CDSH	18 poles + ⊕	87
CNE	10 poles + ⊕	111
CSE	10 poles + ⊕	-
CSH	10 poles + ⊕	111
CSH S	10 poles + ⊕	123
CCE	10 poles + ⊕	131
CMSH	3+2 (aux) poles + ⊕	136
CMCE	3+2 (aux) poles + ⊕	137
CSS	10 poles + ⊕	149
CT, CTSE (16 A)*	10 poles + ⊕	161
CQE	18 poles + ⊕	169
CX	8/24 poles + ⊕	194
MIXO	3 modules	262 - 317

* only for standard insulating version TCHC

refer to CN.19 pages

hoods with 2 levers, top entry SILICONE gasket



FROM JULY 2022

covers SILICONE gasket

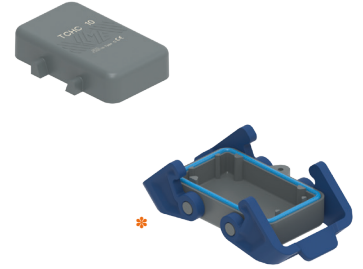

FROM JULY 2022*

description	part No.	entry M	part No. (with eyelet)	part No. (with loop)
with thermoplastic levers and gasket, high construction	TAVC 10 G25	25		
with thermoplastic levers and gasket, high construction	TAVC 10 G32	32		
with 4 pegs			TCHC 10	TCHC 10 S
with 2 thermoplastic levers and gasket				THCC 10 G *

TAVC G

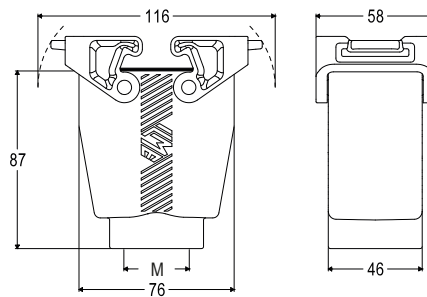

TCHC (S)

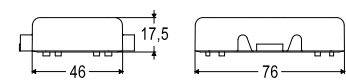

THCC G

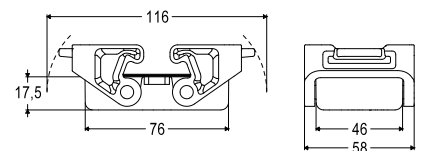

cURus
Type 12 pending



ambient temperature limits -50 °C / +70 °C

For fixing
on housings

eyelet

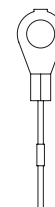

For fixing
on hoods

loop

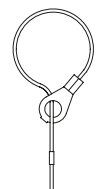

T-TYPE / C for low-temperature HYGIENIC SERIES

inserts

CD	40 poles + ⊕	70
CDD	72 poles + ⊕	79
CDS	27 poles + ⊕	-
CDSH	27 poles + ⊕	88
CNE	16 poles + ⊕	112
CSE	16 poles + ⊕	-
CSH	16 poles + ⊕	112
CSH S	16 poles + ⊕	124
CCE	16 poles + ⊕	132
CM SH, CMCE	6+2 (aux) poles + ⊕	138 - 139
CSS	16 poles + ⊕	150
CT, CTSE (16 A)*	16 poles + ⊕	162
CQE	32 poles + ⊕	170
CQEE	40 poles + ⊕	176
CP	6 poles + ⊕	178
CX	6/12, 6/36 and 12/2 poles + ⊕	197 - 199
CX	4/0 and 4/2 poles + ⊕	200 - 201

* only for standard insulating version THIH

refer to CN.19 pages

page:

**housings with 2 levers
 SILICONE gasket**

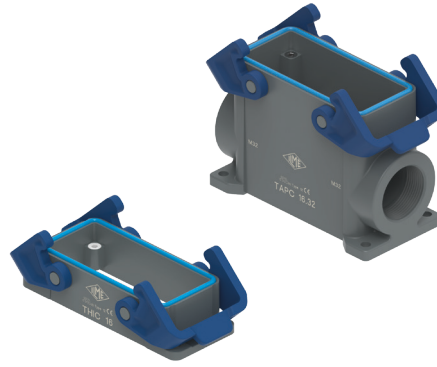

FROM JULY 2022

hoods with 4 pegs



FROM JULY 2022

description	part No.	entry M	part No.	entry M
bulkhead mounting housing with thermoplastic levers	THIC 16			
surface mounting housing, thermoplastic levers, high construction	TAPC 16.32	32		
surface mounting housing, thermoplastic levers, high construction	TAPC 16.40	40		
with pegs, side entry, high construction			TMAO 16.32	32
with pegs, side entry, high construction			TMAO 16.40	40
with pegs, top entry, high construction			TMAV 16.32	32
with pegs, top entry, high construction			TMAV 16.40	40

panel cut-out for bulkhead mounting housings

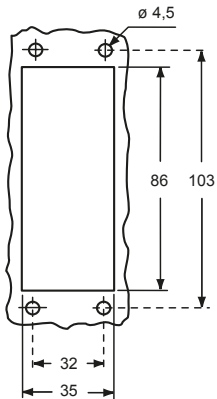

THIC

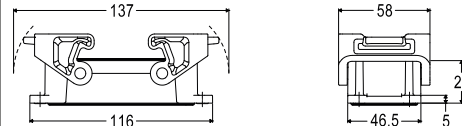

TAPC

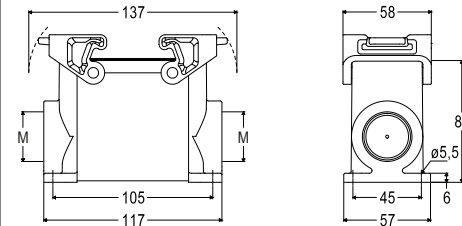

TMAO

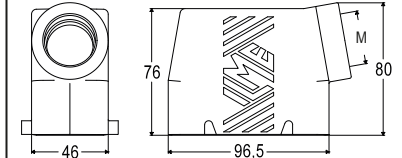

TMAV

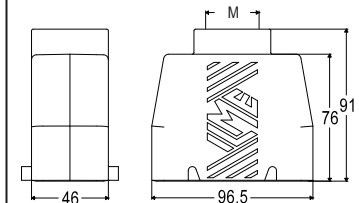

The surface mounting, high construction housings are supplied with an open threaded entry and diametrically opposite a closed threaded entry which can be opened by the user if required (with suitable tool).

cURus
Type 12 pending



ambient temperature limits -50 °C / +70 °C

T-TYPE / C for low-temperature **HYGIENIC SERIES**

inserts		page:
CD	40 poles + ⊕	70
CDD	72 poles + ⊕	79
CDS	27 poles + ⊕	-
CDSH	27 poles + ⊕	88
CNE	16 poles + ⊕	112
CSE	16 poles + ⊕	-
CSH	16 poles + ⊕	112
CSH S	16 poles + ⊕	124
CCE	16 poles + ⊕	132
CMSH, CMCE	6+2 (aux) poles + ⊕	138 - 139
CSS	16 poles + ⊕	150
CT, CTSE (16 A)*	16 poles + ⊕	162
CQE	32 poles + ⊕	170
CQEE	40 poles + ⊕	176
CP	6 poles + ⊕	178
CX	6/12, 6/36 and 12/2 poles + ⊕	197 - 199
CX	4/0 and 4/2 poles + ⊕	200 - 201

* only for standard insulating version THCH

refer to CN.19 pages

hoods with 2 levers, top entry SILICONE gasket



FROM JULY 2022

covers SILICONE gasket

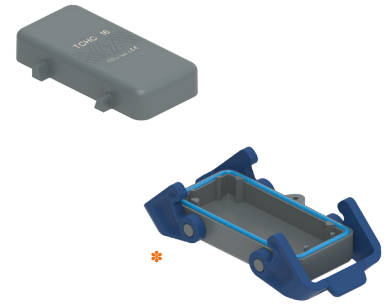

FROM JULY 2022*

description	part No.	entry M	part No. (with eyelet)	part No. (with loop)
with thermoplastic levers and gasket, high construction	TAVC 16 G32	32	TCHC 16	TCHC 16 S
with thermoplastic levers and gasket, high construction	TAVC 16 G40	40		
with 4 pegs				THCC 16 G *
with 2 thermoplastic levers and gasket				

TAVC G

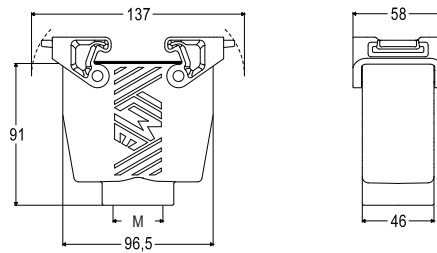

TCHC (S)

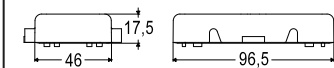

THCC G

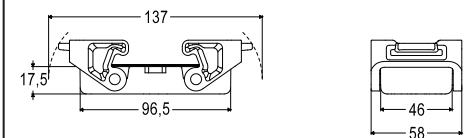

For fixing
on housings

eyelet

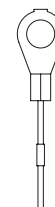

For fixing
on hoods

loop

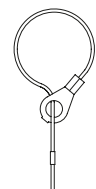

cURus
Type 12 pending



ambient temperature limits -50 °C / +70 °C

T-TYPE / C for low-temperature HYGIENIC SERIES

inserts

insert	poles	page:
CD	64 poles + ⊕	72
CDD	108 poles + ⊕	81
CDS	42 poles + ⊕	-
CDSH	42 poles + ⊕	89
CNE	24 poles + ⊕	113
CSE	24 poles + ⊕	-
CSH	24 poles + ⊕	113
CSH S	24 poles + ⊕	125
CCE	24 poles + ⊕	133
CMSH	10+2 (aux) poles + ⊕	140
CMCE	10+2 (aux) poles + ⊕	141
CSS	24 poles + ⊕	151
CT, CTSE (16 A)*	24 poles + ⊕	163
CQE	46 poles + ⊕	171
CQEE	64 poles + ⊕	177
CX	4/8 and 6/6 poles + ⊕	204, 206
MIXO	6 modules	262 - 317

* only for standard insulating version THIH

refer to CN.19 pages

page:

housings with 2 levers
 SILICONE gasket

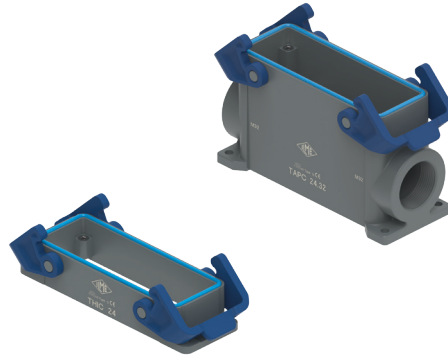

FROM JULY 2022

hoods with 4 pegs



FROM JULY 2022

description	part No.	entry M	part No.	entry M
bulkhead mounting housing with thermoplastic levers	THIC 24			
surface mounting housing, thermoplastic levers, high construction	TAPC 24.32	32		
surface mounting housing, thermoplastic levers, high construction	TAPC 24.40	40		
with pegs, side entry, high construction			TMAO 24.32	32
with pegs, side entry, high construction			TMAO 24.40	40
with pegs, top entry, high construction			TMAV 24.32	32
with pegs, top entry, high construction			TMAV 24.40	40

panel cut-out for bulkhead mounting housings

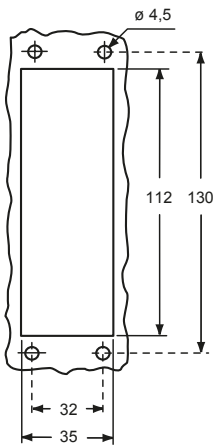

THIC

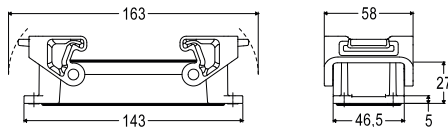

TAPC

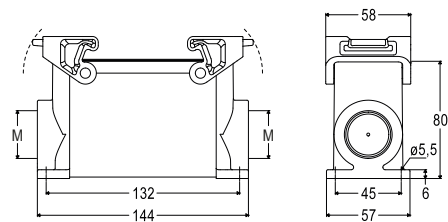

TMAO

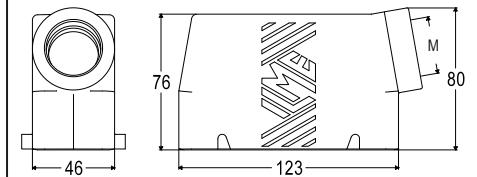

TMAV

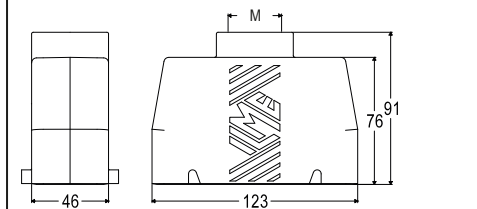

The surface mounting, high construction housings are supplied with an open threaded entry and diametrically opposite a closed threaded entry which can be opened by the user if required (with suitable tool).

cURus
Type 12 pending



ambient temperature limits -50 °C / +70 °C

T-TYPE / C for low-temperature **HYGIENIC SERIES**

inserts		page:
CD	64 poles + ⊕	72
CDD	108 poles + ⊕	81
CDS	42 poles + ⊕	-
CDSH	42 poles + ⊕	89
CNE	24 poles + ⊕	113
CSE	24 poles + ⊕	-
CSH	24 poles + ⊕	113
CSH S	24 poles + ⊕	125
CCE	24 poles + ⊕	133
CMSH	10+2 (aux) poles + ⊕	140
CMCE	10+2 (aux) poles + ⊕	141
CSS	24 poles + ⊕	151
CT, CTSE (16 A)*	24 poles + ⊕	163
CQE	46 poles + ⊕	171
CQEE	64 poles + ⊕	177
CX	4/8 and 6/6 poles + ⊕	204, 206
MIXO	6 modules	262 - 317

* only for standard insulating version TCHC

refer to CN.19 pages

hoods with 2 levers, top entry SILICONE gasket



FROM JULY 2022

covers SILICONE gasket

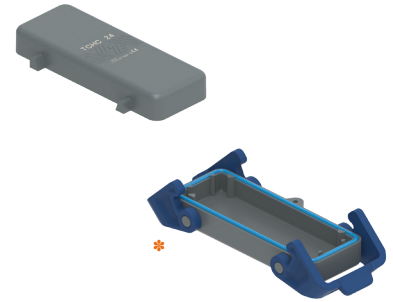

FROM JULY 2022*

description	part No.	entry M	part No. (with eyelet)	part No. (with loop)
with thermoplastic levers and gasket, high construction	TAVC 24 G32	32	TCHC 24	TCHC 24 S
with thermoplastic levers and gasket, high construction with 4 pegs	TAVC 24 G40	40		THCC 24 G *
with 2 thermoplastic levers and gasket				

TAVC G

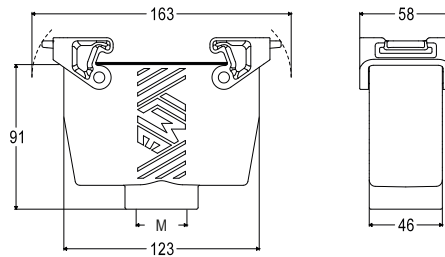

TCHC (S)

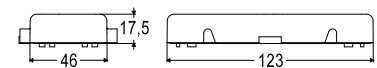

THCC G

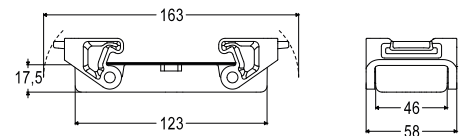

cURus
Type 12 pending



ambient temperature limits -50 °C / +70 °C

For fixing
on housings

eyelet

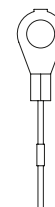

For fixing
on hoods

loop

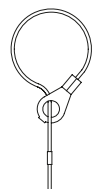

RXC SERIES COMBINED CRIMP CONNECTOR

HNM VERSION

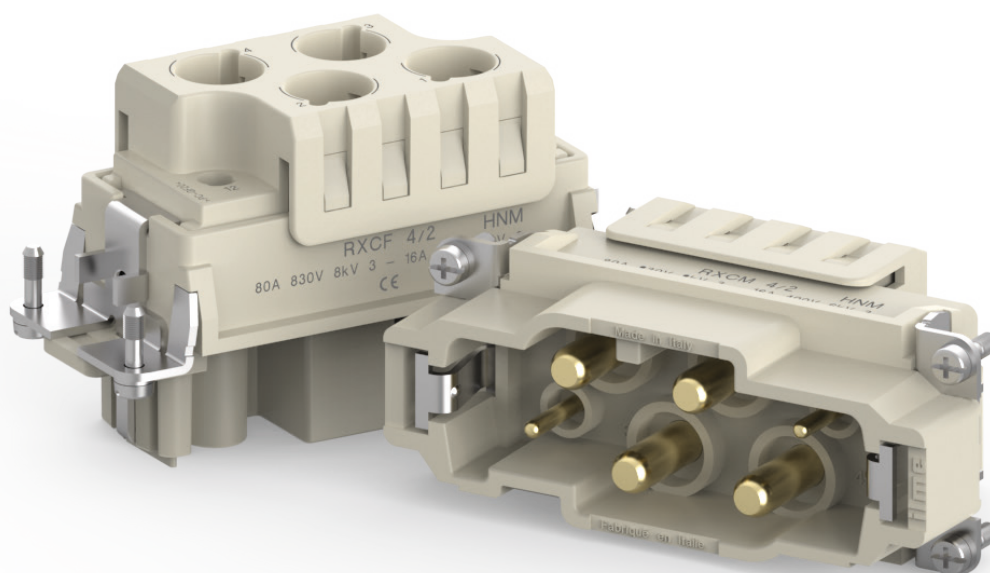

**RXCF /M 4/2 Combined power/auxiliaries
crimp connector**

(HNM version of CXC)

4 P + ⊕: 80 A 830 V 8 kV 3

2 P + ⊕: 16 A 400 V 6 kV 3



Find out more
www.ilme.com

TECHNICAL FEATURES

The new combined connectors **RXC 4/2** are the **HNM version** of the recently introduced CXC 4/2 inserts with 4× 80 A power crimp contact seats and 2× 16 A auxiliary crimp contact seats.

- Q Thanks to the **HNM treatment** (PE plates lubrication and RX7..2D and RC..2D HNM series crimp contacts with special gold plating, rated current 80 A and 16 A respectively), the mechanical life, when used in combination with dedicated HNM enclosures, extends from 500 to **10 000 mating cycles** ensuring optimal performance.
- Q The connectors are ideal for **applications** requiring frequent **disconnection** use: test benches, charging systems, and removable tooling equipment.

- ▶ To be used with HNM crimp contacts series RX7 (70 A / 80 A) and RC (16 A) in HNM enclosures, for up to 10 000 matings

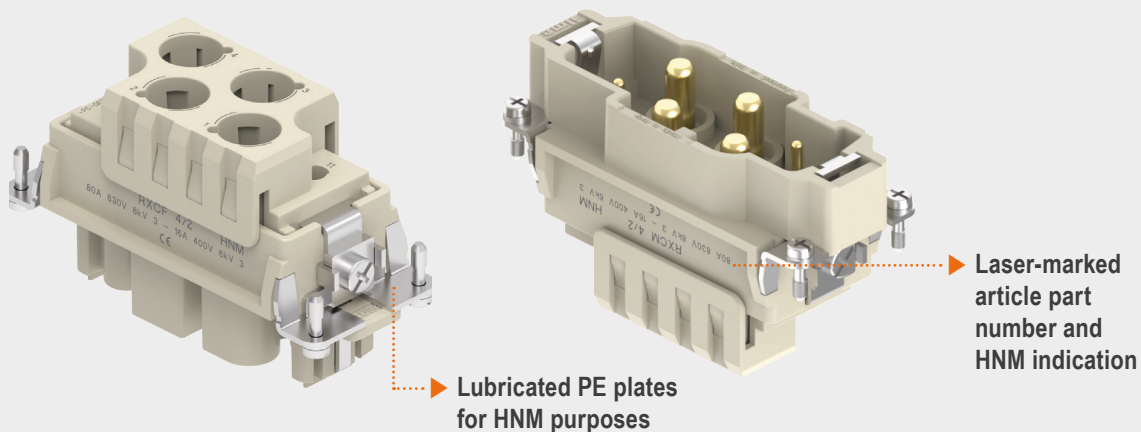

✍ HNM crimp contacts RX7 and RC series are separately available

RXCF /M 4/2 4 poles (80 A - 830 V) + 2 poles (16 A - 400 V) + ⊕ HNM (High Number of Matings)

enclosures:
size "77.27"

page:

HNM

596 - 597

Enclosures: bulkhead mounting housings, high construction housings or high construction hoods

HNM inserts, crimp connections

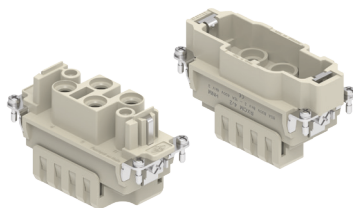

Q 10 000 MATINGS
WITH HNM ENCLOSURES

RATING 830V

FROM MARCH 2022

80 A HNM crimp contacts
gold plated



FROM MARCH 2022

refer to CN.19 pages

description

part No.

part No.

without contacts (to be ordered separately)
female insert for female contacts
male insert for male contacts

RXCF 4/2
RXCM 4/2

80 A female crimp contacts

6 mm ²	(Class 5)	AWG 10
10 mm ²	(Class 5)	AWG 8 - 7
16 mm ²	(Class 5)	AWG 6 - 5
16 mm ²	(Class 6)	AWG 6 - 5
25 mm ²	(Class 5)	AWG 4 - 3

80 A male crimp contacts

6 mm ²	(Class 5)	AWG 10
10 mm ²	(Class 5)	AWG 8 - 7
16 mm ²	(Class 5)	AWG 6 - 5
16 mm ²	(Class 6)	AWG 6 - 5
25 mm ²	(Class 5)	AWG 4 - 3

RX7F2D 6.0
RX7F2D 10
RX7F2D 16
RX7F2D 16 XF
RX7F2D 25

gold plated

RX7M2D 6.0
RX7M2D 10
RX7M2D 16
RX7M2D 16 XF
RX7M2D 25

- characteristics according to EN/IEC 61984 ratings:

80 A 830 V 8 kV 3
16 A 400 V 6 kV 3

- cURus, CSA, CQC, DNV-GL, BV, EAC pending
- rated voltage according to UL/CSA: 600 V
- insulation resistance: ≥ 10 G Ω
- Lower and Upper Limiting Temperatures (LLT ... ULT):
-40 °C ... +125 °C
- made by UL 94V-0 glass reinforced polycarbonate, EN 45545-2:2015 compliant
- mechanical life: ≥ 10.000 cycles
- contact resistance: $\leq 0,3$ m Ω (4 power poles)
 ≤ 1 m Ω (2 auxiliary poles)

- it is recommended to crimp the contacts with crimping tools homologated by ILME (please see the crimping tool section 70 A contacts RX7F2D and RX7M2D series and 16 A contacts RCF2D, RCM2D series, on pages 708 - 741 of CN.19 catalogue)

- for max. current load see the connector inserts derating diagrams below; for more information see page 28 of CN.19 catalogue

RXC 4/2

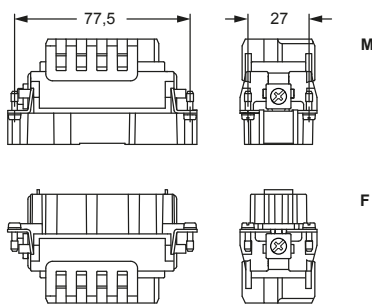

contacts side (front view)

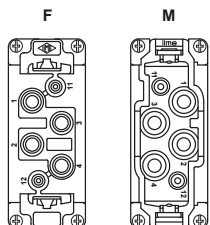

RX7F2D, RX7M2D and
RX7F2D 16 XF, RX7M2D 16 XF

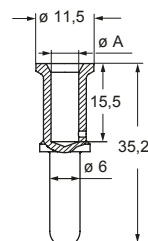

RX7F2D and RX7M2D contacts			
conductor section (mm ²)	conductor slot ϕ A (mm)	conductor stripping length (mm)	
6	3,5	15	
10	4,3	15	
16	5,5	15	
16 (XF)	6,1	15	
25	7,0	15	

RXC 4/2 poles connector inserts

Maximum current load derating diagram

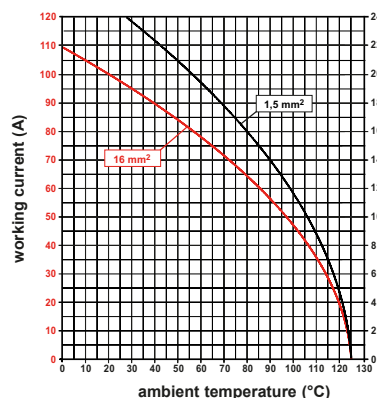
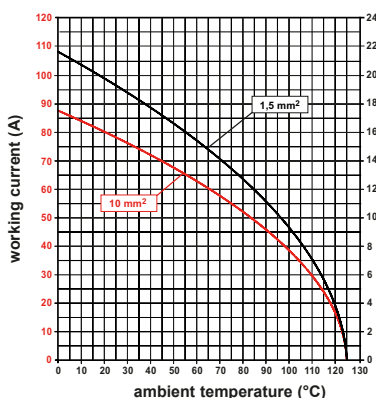
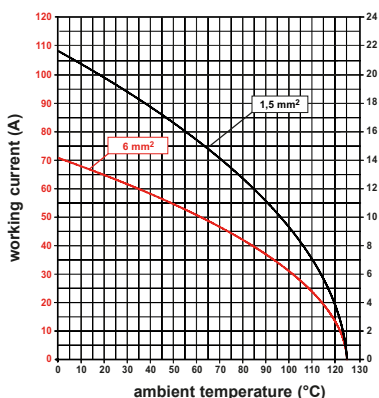

16 A HNM crimp contacts gold plated



removal tools



description

part No.

part No.

16 A female contacts, HNM gold plated

0,14-0,37 mm ²	AWG 26-22	one groove
0,5 mm ²	AWG 20	with no grooves
0,75 mm ²	AWG 18	one groove (back side)
1 mm ²	AWG 18	one groove
1,5 mm ²	AWG 16	two grooves
2,5 mm ²	AWG 14	three grooves
3 mm ²	AWG 12	one wide groove
4 mm ²	AWG 12	with no grooves

RCF2D 0.3
RCF2D 0.5
RCF2D 0.7
RCF2D 1.0
RCF2D 1.5
RCF2D 2.5
RCF2D 3.0
RCF2D 4.0

gold plated

16 A male contacts, HNM gold plated

0,14-0,37 mm ²	AWG 26-22	one groove
0,5 mm ²	AWG 20	with no grooves
0,75 mm ²	AWG 18	one groove (back side)
1 mm ²	AWG 18	one groove
1,5 mm ²	AWG 16	two grooves
2,5 mm ²	AWG 14	three grooves
3 mm ²	AWG 12	one wide groove
4 mm ²	AWG 12	with no grooves

RCM2D 0.3
RCM2D 0.5
RCM2D 0.7
RCM2D 1.0
RCM2D 1.5
RCM2D 2.5
RCM2D 3.0
RCM2D 4.0

removal tools

for **RX7F2D** and **RX7M2D** series contacts
for **RCF2D** and **RCM2D** series contacts

CX7ES
CQES

RCF2D and RCM2D

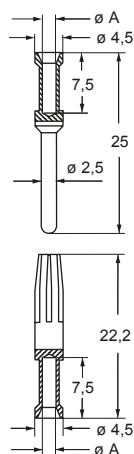

RCF2D and RCM2D contacts

conductor section mm ²	conductor slot $\varnothing A$ (mm)	conductors stripping length (mm)
0,14-0,37	0,9	7,5
0,5	1,1	7,5
0,75	1,3	7,5
1,0	1,45	7,5
1,5	1,8	7,5
2,5	2,2	7,5
3	2,55	7,5
4	2,85	7,5

RXC SERIES COMBINED CRIMP CONNECTOR

HNM VERSION

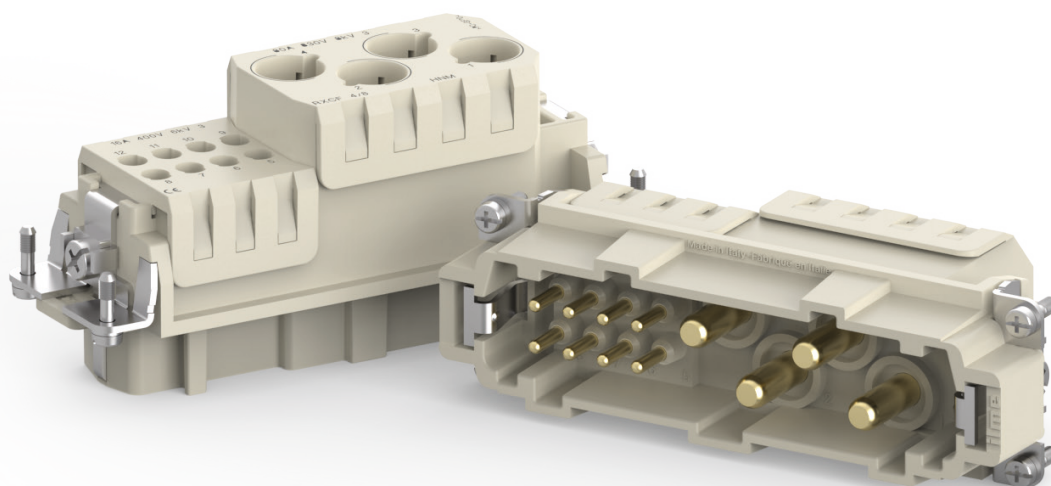

**RXCF /M 4/8 Combined power/auxiliaries
crimp connector**

(HNM version of CXC)

4 P + ⊕: 80 A 400 V 6 kV 3

8 P + ⊕: 16 A 230/400 V 4 kV 3



Find out more
www.ilme.com

TECHNICAL FEATURES

The new combined crimp connectors **RXC 4/8** are the **HNM version** of the recently introduced CXC 4/8 inserts with 4× 80 A power crimp contact seats and 8× 16 A auxiliary crimp contact seats.

- Q Thanks to the **HNM treatment** (PE plates lubrication and RX7..2D and RC..2D HNM series crimp contacts with special gold plating, rated current 80 A and 16 A respectively), the mechanical life, when used in combination with dedicated HNM enclosures, extends from 500 to **10 000 mating cycles** ensuring optimal performance.
- Q The connectors are ideal for **applications** requiring frequent **disconnection** use: test benches, charging systems, and removable tooling equipment.

- ▶ To be used with HNM crimp contacts series RX7 (70 A / 80 A) and RC (16 A) in HNM enclosures, for up to 10 000 matings

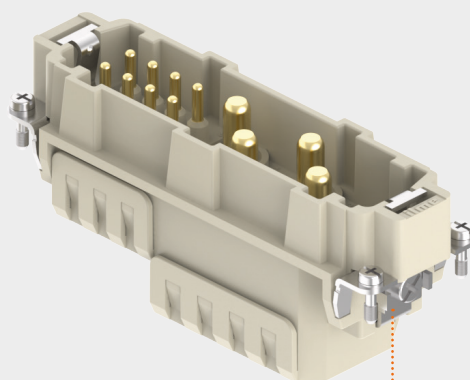
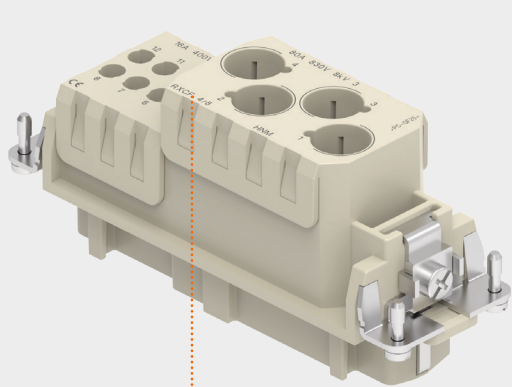

✍ HNM crimp contacts RX7 and RC series are separately available

▶ Laser-marked article part number and HNM indication

▶ Lubricated PE plates for HNM purposes

CXCF /M 4/8 4 poles (80 A - 400 V) + 8 poles (16 A - 230/400 V) + ⊕ HNM (High Number of Matings)

enclosures:
size "104.27"

page:

HNM

598 - 599

Enclosures: bulkhead mounting housings, high construction housings or high construction hoods

HNM inserts, crimp connections

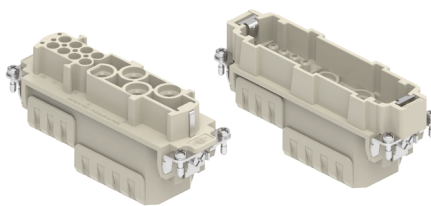

Q 10 000 MATINGS
WITH HNM ENCLOSURES

RATING 830V

FROM MARCH 2022

80 A HNM crimp contacts
gold plated



FROM MARCH 2022

refer to CN.19 pages

description

part No.

part No.

without contacts (to be ordered separately)
female inserts for female contacts
male inserts for male contacts

RXCF 4/8
RXCM 4/8

80 A female crimp contacts

6 mm ²	(Class 5)	AWG 10
10 mm ²	(Class 5)	AWG 8 - 7
16 mm ²	(Class 5)	AWG 6 - 5
16 mm ²	(Class 6)	AWG 6 - 5
25 mm ²	(Class 5)	AWG 4 - 3

80 A male crimp contacts

6 mm ²	(Class 5)	AWG 10
10 mm ²	(Class 5)	AWG 8 - 7
16 mm ²	(Class 5)	AWG 6 - 5
16 mm ²	(Class 6)	AWG 6 - 5
25 mm ²	(Class 5)	AWG 4 - 3

RX7F2D 6.0
RX7F2D 10
RX7F2D 16
RX7F2D 16 XF
RX7F2D 25

gold plated

RX7M2D 6.0
RX7M2D 10
RX7M2D 16
RX7M2D 16 XF
RX7M2D 25

- characteristics according to EN/IEC 61984 ratings:

80 A 400 V 6 kV 3
16 A 230/400 V 4 kV 3

- cURus, CSA, CQC, DNV-GL, BV, EAC pending
- rated voltage according to UL/CSA: 600 V
- insulation resistance: ≥ 10 G Ω
- ambient temperature limit: -40 °C ... +125 °C
- made by UL 94V-0 glass reinforced polycarbonate, EN 45545-2:2015 compliant
- mechanical life: ≥ 500 cycles
- contact resistance: $\leq 0,3$ m Ω (4 power poles)
 ≤ 1 m Ω (8 auxiliary poles)

- it is recommended to crimp the contacts with crimping tools homologated by ILME (please see the crimping tool section 70 A contacts RX7F2D and RX7M2D series and 16 A contacts RCF2D, RCM2D series, on pages 708 - 741 of CN.19 catalogue)

- for max. current load see the connector inserts derating diagrams below; for more information see page 28 of CN.19 catalogue

RXC 4/8

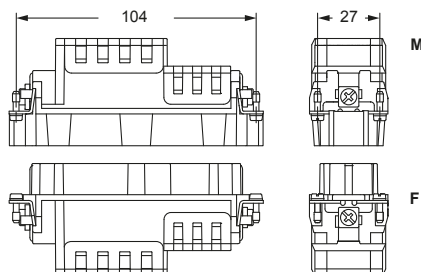

contacts side (front view)

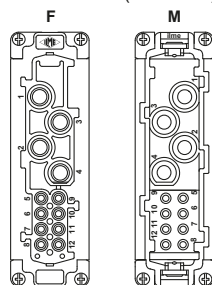

RX7F2D, RX7M2D and
RX7F2D 16 XF, RX7M2D 16 XF

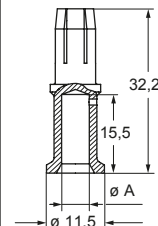
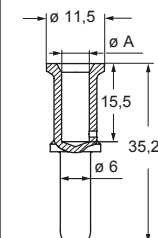

RXC 4/8 poles connector inserts

Maximum current load derating diagram

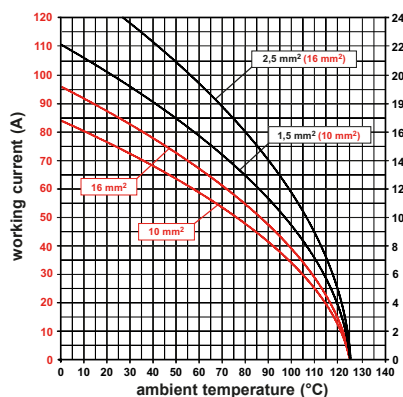
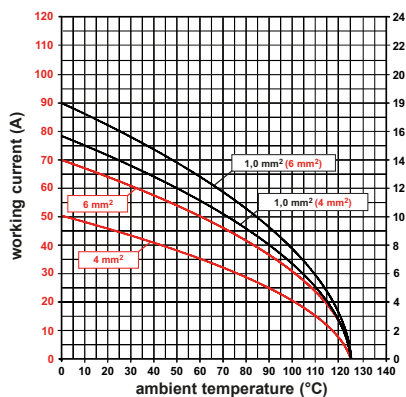

RX7F2D and RX7M2D contacts

conductor section (mm ²)	conductor slot \varnothing A (mm)	conductor stripping length (mm)
6	3,5	15
10	4,3	15
16	5,5	15
16 (XF)	6,1	15
25	7,0	15

16 A HNM crimp contacts gold plated



removal tools



description

part No.

part No.

16 A female contacts, HNM gold plated

0,14-0,37 mm ²	AWG 26-22	one groove
0,5 mm ²	AWG 20	with no grooves
0,75 mm ²	AWG 18	one groove (back side)
1 mm ²	AWG 18	one groove
1,5 mm ²	AWG 16	two grooves
2,5 mm ²	AWG 14	three grooves
3 mm ²	AWG 12	one wide groove
4 mm ²	AWG 12	with no grooves

RCF2D 0.3
RCF2D 0.5
RCF2D 0.7
RCF2D 1.0
RCF2D 1.5
RCF2D 2.5
RCF2D 3.0
RCF2D 4.0

gold plated

16 A male contacts, HNM gold plated

0,14-0,37 mm ²	AWG 26-22	one groove
0,5 mm ²	AWG 20	with no grooves
0,75 mm ²	AWG 18	one groove (back side)
1 mm ²	AWG 18	one groove
1,5 mm ²	AWG 16	two grooves
2,5 mm ²	AWG 14	three grooves
3 mm ²	AWG 12	one wide groove
4 mm ²	AWG 12	with no grooves

RCM2D 0.3
RCM2D 0.5
RCM2D 0.7
RCM2D 1.0
RCM2D 1.5
RCM2D 2.5
RCM2D 3.0
RCM2D 4.0

removal tools

for **RX7F2D** and **RX7M2D** series contacts
for **RCF2D** and **RCM2D** series contacts

CX7ES
CQES

RCF2D and RCM2D

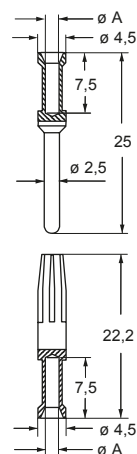

RCF2D and RCM2D contacts

conductor section mm ²	conductor slot ø A (mm)	conductors stripping length (mm)
0,14-0,37	0,9	7,5
0,5	1,1	7,5
0,75	1,3	7,5
1,0	1,45	7,5
1,5	1,8	7,5
2,5	2,2	7,5
3	2,55	7,5
4	2,85	7,5

SIZE “21.21” ENCLOSURES

HNM VERSION



**Size “21.21” metallic housings
(bulkhead and surface mounting)
and hoods with CLASS lever,
suitable for up to 5 000 mating cycles**



Find out more
www.ilme.com

TECHNICAL FEATURES

Housings (bulkhead-mounting or surface mounting) size “21.21” equipped with **CLASS single locking lever**, made by stainless-steel with sintered stainless-steel rolls with special **anti-friction treatment**

Q *to be mated to standard hoods* “size 21.21”.

This **HNM** series of connector housings has been developed to be used in combination with the **HNM** series of size “21.21” multipole connector inserts, equipped with the relevant **HNM** series of removable crimp contacts, to provide the same reliable protection of the standard series but for a consistently extended, **high number of matings**.

The CLASS locking lever has been chosen and treated so as to reduce wear due to friction at minimum.

Even mated on standard hoods, it is able to provide extremely reduced wear on the corresponding locking pegs, producing virtually no friction by the application of special lubrication on the hinged rolls.

The counterpart hoods are therefore standard metallic types, with fused pegs.

Currently (see next pages) the **suitable HNM inserts size “21.21”** for these new HNM housings are:

- Q **CQF /M 21** inserts
with **5 A HNM** crimp contacts series **RI**
- Q **CDF /M 08** inserts
with **10 A HNM** crimp contacts series **RD**
- Q **New RQF /M 05** inserts,
special **HNM** screw-type PE terminal,
with **16 A HNM** crimp contacts series **RC**
- Q **CQ4F /M 03**
with **40 A HNM** crimp contacts series **RX**

NOTE – Series CKSH (SQUICH®), as well as all MIXO BUS multi-axial and coaxial inserts for use within the size “21.21” CX 1/2 BDF /BDM adapter are not foreseen in HNM version. For requests of other size “21.21” connector inserts in HNM version (e.g.: RK, RQ 12, RQ 07), please contact ILME Commercial Offices.

When the number of 500 mating cycles guaranteed life of standard connector hoods and housings is insufficient to provide a reasonably long lifespan in those connector applications that by inherent function are foreseen to be subject to very frequent connections and disconnections, it is necessary to opt for a solution able to increase that guaranteed lifetime.

- Q The **HNM size “21.21”** series of connector enclosures achieves this goal, extending the guaranteed number of matings **up to 5 000**.

► **Original design, ILME exclusive**
in the market for rectangular connectors

Special
lubrication
of the lever
rolls



► **Special gold plating and lubrication** to reduce the wear of the contacts during frequently repeated mating/unmating operations



inserts		page:
CQ	21 poles	82
CD	8 poles	83
RQ	5 poles + ⊕	84
CQ4 03	3 poles + ⊕	85

**bulkhead mounting housings
straigh, stainless steel lever**



FROM JUNE 2022

**bulkhead mounting housings
angled, stainless steel lever**

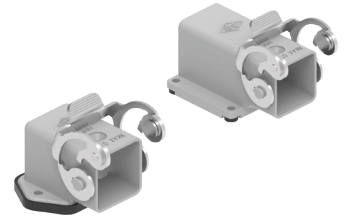

FROM JUNE 2022

description	part No.	part No.
with stainless steel lever	RKAX 03 I	RKAX 03 IA
without cable entry ¹⁾		RKAX 03 IA4
without cable entry, fixing by 4 screws		CKR 65
gasket and screw kit	CKR 65	CKR 65
for IP66 ²⁾		
gasket and screw kit for IP66 ²⁾	CKR 65 D	CKR 65 D
specific for CD 07/08 inserts		

¹⁾ Not suitable for CQ4 series inserts

²⁾ To obtain the IP66 degree of protection it is necessary to replace the fixing screw supplied with the above listed inserts, with the one with gasket included in the kit (to be purchased separately).

NOTE: The enclosure shown here is an example. The screw and sealing gasket kit can be used with all enclosures' part nos. in this page.

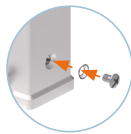

RKAX 03 I

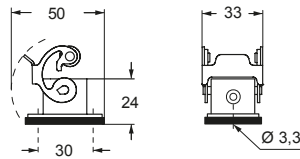

panel cut-out for enclosures

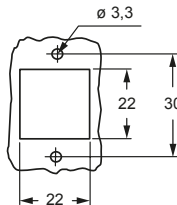

RKAX 03 IA

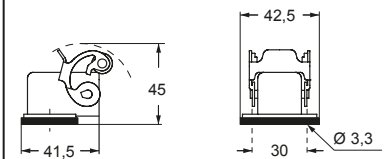

panel cut-out for enclosures

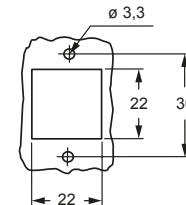

RKAX 03 IA4

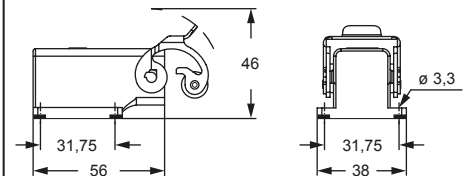

panel cut-out for enclosures

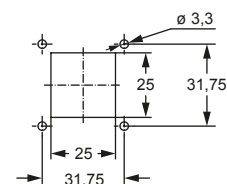

cURus
Type 12 pending
Type 4/4X only with CKR 65 (D) pending



IP66 with CKR 65 (D) ²⁾

RKAX VG

HNM (High Number of Matings)

inserts		page:
CQ	21 poles	82
CD	8 poles	83
RQ	5 poles + ⊕	84
CQ4 03	3 poles + ⊕	85

hoods
stainless steel lever



FROM JUNE 2022

hoods
stainless steel lever

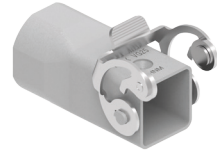

FROM JUNE 2022

description	part No. (entry M20)	part No. (entry M25)
top entry ¹⁾	RKAX VG20	
top entry		RKAX VG25
gasket and screw kit for IP66 ²⁾	CKR 65	CKR 65
gasket and screw kit for IP66 ²⁾ specific for CD 08 inserts	CKR 65 D	CKR 65 D

¹⁾ Not suitable for CQ4 series inserts

²⁾ To obtain the IP66 degree of protection it is necessary to replace the fixing screw supplied with the above listed inserts, with the one with gasket included in the kit (to be purchased separately).

NOTE: The enclosure shown here is an example. The screw and sealing gasket kit can be used with all enclosures' part nos. in this page.

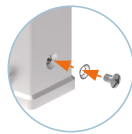

RKAX VG20

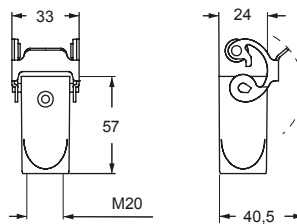

RKAX VG25

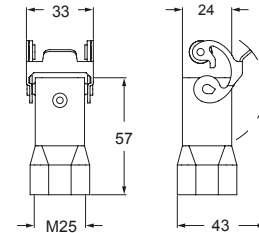

cURus
Type 12 pending
Type 4/4X only with CKR 65 (D) pending



IP66 with CKR 65 (D) ²⁾

inserts

CQ	21 poles
CD	8 poles
RQ	5 poles + ⊕
CQ4 03	3 poles + ⊕

page:

82
83
84
85

**bulkhead mounting housings
straight and angled, stainless steel lever**

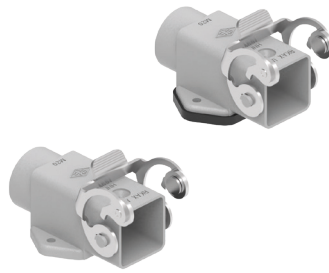

FROM JUNE 2022

**angled surface mounting housings
stainless steel lever**

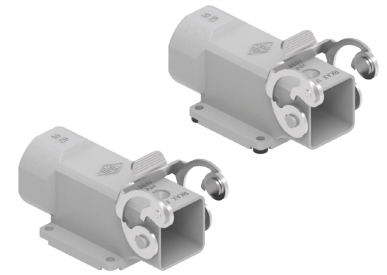

FROM JUNE 2022

description

part No.
(entry M20)

part No.
(entry M25)

with cable entry ¹⁾
with cable entry, bulkhead hole closed, without gasket ¹⁾

RKAX IAP20
RKAX AP20

RKAX IAP25
RKAX AP25

with cable entry, fixing by 4 screws
with cable entry, fixing by 4 screws,
bulkhead hole closed, without gasket

CKR 65

CKR 65

gasket and screw kit
for IP66 ²⁾

CKR 65 D

CKR 65 D

gasket and screw kit for IP66 ²⁾
specific for CD 07/08 inserts

¹⁾ Not suitable for CQ4 series inserts

²⁾ To obtain the IP66 degree of protection it is necessary to replace the fixing screw supplied with the above listed inserts, with the one with gasket included in the kit (to be purchased separately).

NOTE: The enclosure shown here is an example. The screw and sealing gasket kit can be used with all enclosures' part nos. in this page.

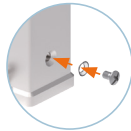

RKAX IAP20 (RKAX AP20*)

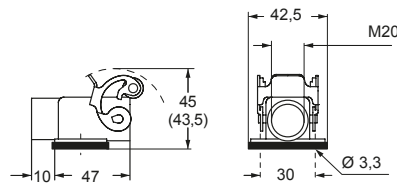

*AP... without gasket

panel cut-out for enclosures

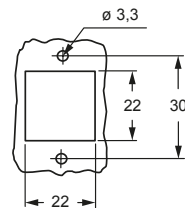

RKAX IAP25

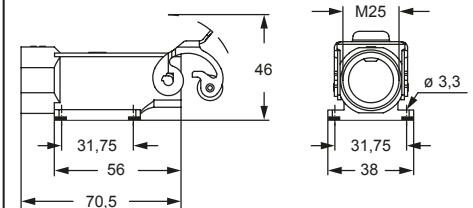

panel cut-out for enclosures

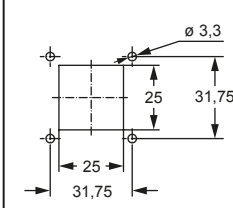

RKAX AP25

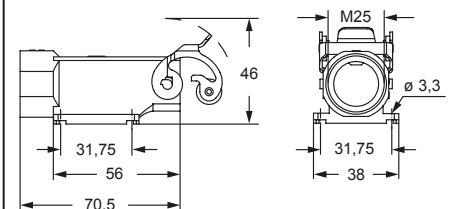

panel cut-out for enclosures

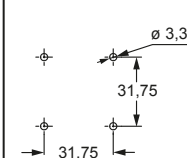

cURus
Type 12 pending
Type 4/4X only with CKR 65 (D) pending



IP66 with CKR 65 (D) ²⁾

RKAX IF – IAF

HNM (High Number of Matings)

inserts		page:
CQ	21 poles	82
CD	8 poles	83
RQ	5 poles + ⊕	84
CQ4 03	3 poles + ⊕	85

bulkhead mounting housings stainless steel lever



FROM JUNE 2022

angled bulkhead mounting housings stainless steel lever

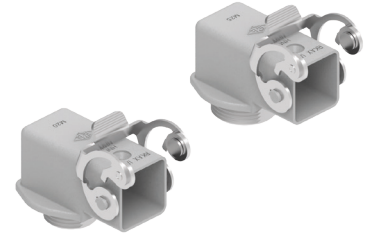

FROM JUNE 2022

description	part No.	entry M	part No.	entry M
with O-ring gasket ^{1) (1)}	RKAX IF	32	RKAX IAF20	20
with flange gasket ¹⁾	RKAX IFC	32	RKAX IAF25	25
with O-ring gasket ^{1) 2) (1)}			CKR 65	
with O-ring gasket ^{1) 2) (1)}			CKR 65 D	
gasket and screw kit for IP66 ²⁾	CKR 65		CKR 65	
gasket and screw kit for IP66 ²⁾ specific for CD 07/08 inserts	CKR 65 D		CKR 65 D	

¹⁾ To obtain the IP66 degree of protection it is necessary to replace the fixing screw supplied with the above listed inserts, with the one with gasket included in the kit (to be purchased separately).

NOTE: The enclosure shown here is an example. The screw and sealing gasket kit can be used with all enclosures' part nos. in this page

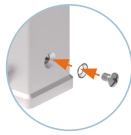

²⁾ Not suitable for CQ4 series inserts

⁽¹⁾ Locknut supplied on request, see Cable glands catalogue (article AS M32N metallic).

RKAX IF

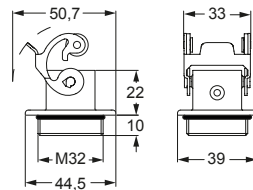

RKAX IFC

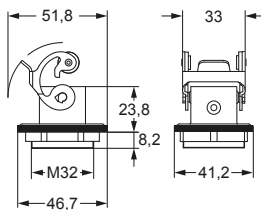

panel cut-out for enclosures

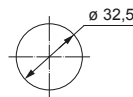

USE OF THE LOCKNUT

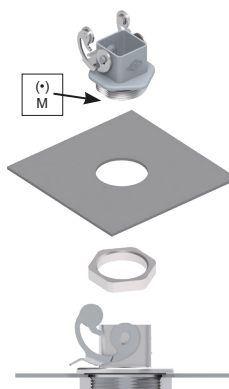

MKAX IAF

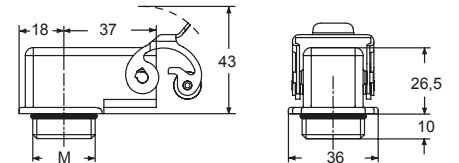

panel cut-out

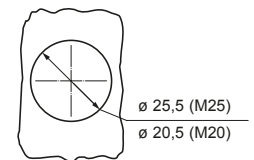

USE OF THE LOCKNUT

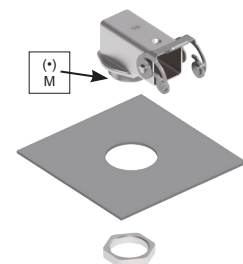

cURus
Type 12 pending
Type 4/4X only with CKR 65 (D) pending



IP66 with CKR 65 (D) ²⁾

enclosures:
size "21.21"

page:

HNM

78 - 81

inserts, crimp connections



5 A HNM crimp contacts
gold plated



description

part No.

part No.

without contacts (to be ordered separately)
female insert for female contacts
male insert for male contacts

CQF 21
CQM 21

5 A female crimp contacts
0,08-0,21 mm² AWG 28-24
0,13-0,33 mm² AWG 26-22
0,33-0,52 mm² AWG 22-20

RIFD 0.2
RIFD 0.3
RIFD 0.5

gold plated

5 A male crimp contacts
0,08-0,21 mm² AWG 28-24
0,13-0,33 mm² AWG 26-22
0,33-0,52 mm² AWG 22-20

RIMD 0.2
RIMD 0.3
RIMD 0.5

- characteristics according to EN 61984:
6,5 A 50 Vac / 120 Vdc 0,8 kV 3

- cULus (UL for USA and Canada),
BUREAU VERITAS certified

- rated voltage according to UL/CSA: 250V
- insulation resistance: $\geq 10 \text{ G}\Omega$
- ambient temperature limit: $-40 \text{ }^\circ\text{C} \dots +125 \text{ }^\circ\text{C}$
- made of self-extinguishing thermoplastic resin UL 94V-0
- mechanical life: $\geq 5 \text{ 000}$ cycles
- contact resistance: $\leq 4 \text{ m}\Omega$
- seat of contact #9 on both inserts set forward to obtain pre-leading contact (e.g. for FE functional earth)

- for crimp contacts RI series use, see pages 716 - 719 on CN.19 catalogue
CIPZ D crimping tool
CITP D turret head
CIES insertion / removal tool

- for max. current load see the connector inserts derating diagram below; for more information see page 28 of CN.19 catalogue

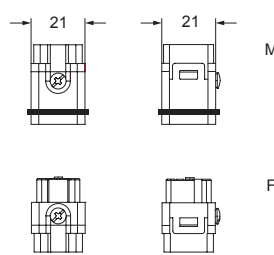

contacts side (front view)

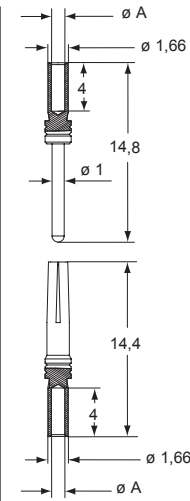

RIF and RIM contacts

conductor section (mm ²)	conductor slot ø A (mm)	conductors stripping length (mm)
0,08-0,21	0,64	4
0,13-0,33	0,90	4
0,33-0,52	1,12	4

CQ 21 poles connector inserts
Maximum current load derating diagram

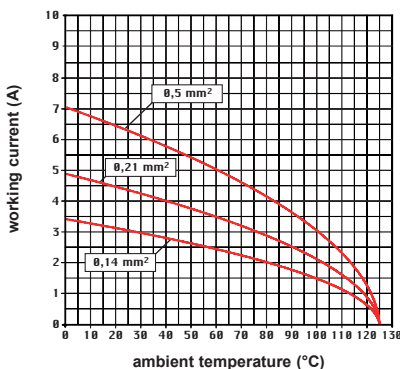

enclosures:
size "21.21"

page:

HNM

78 - 81

inserts, crimp connections

10 A HNM crimp contacts
gold plated

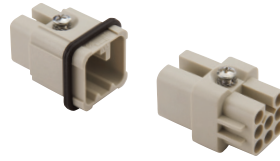

description

part No.

part No..

without contacts (to be ordered separately)
female insert for female contacts ¹⁾
male insert for male contacts

CD F 08
CD M 08

10 A female contacts

0,14-0,37 mm ²	AWG 26-22	identification No. 1
0,5 mm ²	AWG 20	identification No. 2
0,75 mm ²	AWG 18	identification No. ②
1 mm ²	AWG 18	identification No. 3
1,5 mm ²	AWG 16	identification No. 4
2,5 mm ²	AWG 14	identification No. 5

RDF2D 0.3
RDF2D 0.5
RDF2D 0.7
RDF2D 1.0
RDF2D 1.5
RDF2D 2.5

gold plated

10 A male contacts

0,14-0,37 mm ²	AWG 26-22	identification No. 1
0,5 mm ²	AWG 20	identification No. 2
0,75 mm ²	AWG 18	identification No. ②
1 mm ²	AWG 18	identification No. 3
1,5 mm ²	AWG 16	identification No. 4
2,5 mm ²	AWG 14	identification No. 5

RDM2D 0.3
RDM2D 0.5
RDM2D 0.7
RDM2D 1.0
RDM2D 1.5
RDM2D 2.5

1) the female inserts can be mounted into the straight bulkhead housings CK I from the rear

- characteristics according to EN 61984:
10A 50 Vac / 120 Vdc 0,8 kV 3

- cULus (UL for USA and Canada), certified

- rated voltage according to UL/CSA: 50V ac / 120V dc
- insulation resistance: $\geq 10 \text{ G}\Omega$
- ambient temperature limit: -40 °C ... +125 °C
- made of self-extinguishing thermoplastic resin UL 94V-0
- mechanical life: $\geq 5 \text{ 000}$ cycles
- contact resistance: $\leq 3 \text{ m}\Omega$
- for applications requiring higher voltages, please see the special voltage application section refer to C.19 catalogue on page 65
- **it is recommended to crimp the contacts with crimping tools homologated by ILME** (please see the crimping tool section 10 A contacts, CDF and CDM series see pages 708 - 741 on CN.19)
- for max. current load see the connector inserts derating diagram below; for more information see **page 28** of CN.19 catalogue

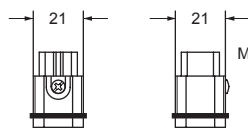

contacts side (front view)

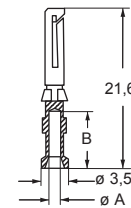
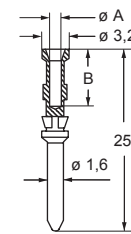
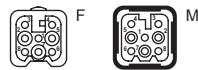

RDF2D and RDM2D contacts

conductor section mm ²	conductor slot $\varnothing A$ (mm)	conductors stripping length B (mm)
0,14-0,37	0,9	8
0,5	1,1	8
0,75	1,3	8
1,0	1,45	8
1,5	1,8	8
2,5	2,2	6

CD 08 poles connector inserts

Maximum current load derating diagram

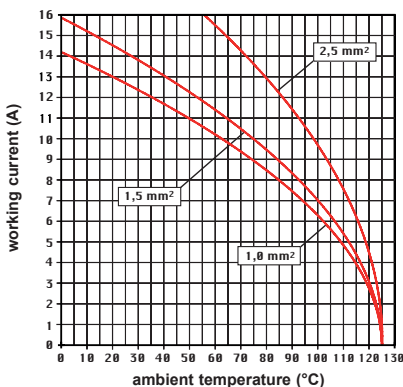

CR CP coding pin with loss of one contact (refer to CN.19, page 689)



enclosures:
size "21.21"

page:

HNM

78 - 81

HNM inserts, crimp connections

16 A HNM crimp contacts
gold plated

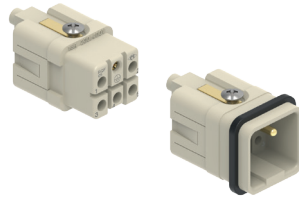

FROM JUNE 2022

description

part No.

part No.

without contacts (to be ordered separately)
female insert for female contacts
male insert for male contacts

RQF 05
RQM 05

16 A female contacts

0,14-0,37 mm ²	AWG 26-22	one groove
0,5 mm ²	AWG 20	with no grooves
0,75 mm ²	AWG 18	one groove (back side)
1 mm ²	AWG 18	one groove
1,5 mm ²	AWG 16	two grooves
2,5 mm ²	AWG 14	three grooves
3 mm ²	AWG 12	one wide groove
4 mm ²	AWG 12	with no grooves

RCF2D 0.3
RCF2D 0.5
RCF2D 0.7
RCF2D 1.0
RCF2D 1.5
RCF2D 2.5
RCF2D 3.0
RCF2D 4.0

gold plated

16 A male contacts

0,14-0,37 mm ²	AWG 26-22	one groove
0,5 mm ²	AWG 20	with no grooves
0,75 mm ²	AWG 18	one groove (back side)
1 mm ²	AWG 18	one groove
1,5 mm ²	AWG 16	two grooves
2,5 mm ²	AWG 14	three grooves
3 mm ²	AWG 12	one wide groove
4 mm ²	AWG 12	with no grooves

RCM2D 0.3
RCM2D 0.5
RCM2D 0.7
RCM2D 1.0
RCM2D 1.5
RCM2D 2.5
RCM2D 3.0
RCM2D 4.0

- characteristics according to EN 61984:

16 A 230/400 V 4 kV 3
16 A 320/500 V 4 kV 2

- cURus (UL for USA and Canada) pending
- CQC, DNV-GL, BV, EAC will follow
- rated voltage according to UL/CSA: 600V
- insulation resistance: $\geq 10 \text{ G}\Omega$
- ambient temperature limit: $-40 \text{ }^\circ\text{C} \dots +125 \text{ }^\circ\text{C}$
- made of self-extinguishing thermoplastic resin UL 94V-0
- mechanical life: $\geq 5 \text{ 000}$ cycles
- contact resistance: $\leq 1 \text{ m}\Omega$
- it is recommended to crimp the contacts with crimping tools homologated by ILME (please see the crimping tool section 16 A contacts, RC series see pages 708 - 741 on CN.19 catalogue)
- can also be used partially fitted with 4 mm² section contacts
- for max. current load see the connector inserts derating diagram below; for more information see page 28 of CN.19 catalogue

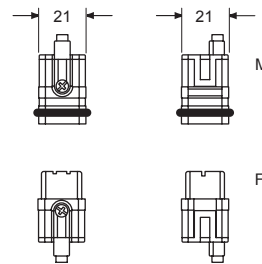

contacts side (front view)



NOTE: PE screw connection for unprepared wires only

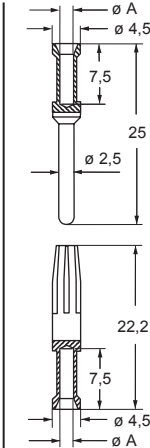

RCF2D and RCM2D contacts

conductor section mm ²	conductor slot ø A (mm)	conductors stripping length (mm)
0,14-0,37	0,9	7,5
0,5	1,1	7,5
0,75	1,3	7,5
1,0	1,45	7,5
1,5	1,8	7,5
2,5	2,2	7,5
3	2,55	7,5
4	2,85	7,5

RQ 05 poles connector inserts

Maximum current load derating diagram

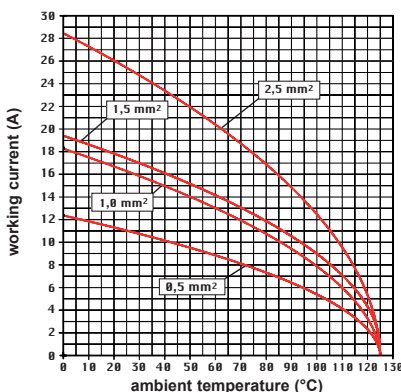

Coding pins
CR CPQ
(refer to CN.19,
page 689)



enclosures:
size "21.21"

page:

HNM

78 - 81

HNM inserts, crimp connections

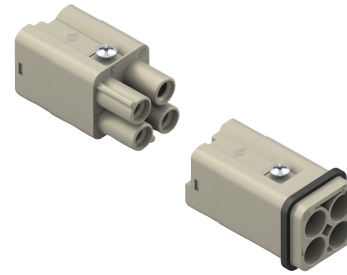

40 A HNM crimp contacts
gold plated



description

part No.

part No.

without contacts (to be ordered separately)
female inserts for female contacts *
male inserts for male contacts *

CQ4F 03
CQ4M 03

40 A female crimp contacts
1,5 mm² AWG 16
2,5 mm² AWG 14
4 mm² AWG 12
6 mm² AWG 10

RXF2D 1.5
RXF2D 2.5
RXF2D 4.0
RXF2D 6.0

gold plated

40 A male crimp contacts
1,5 mm² AWG 16
2,5 mm² AWG 14
4 mm² AWG 12
6 mm² AWG 10

RXM2D 1.5
RXM2D 2.5
RXM2D 4.0
RXM2D 6.0

* wire diameter: up to 7,5 mm, contact section: up to 10 mm²

☑ the female insert **CQ4F 03** is finger proof (IP2X or IPXXB) even if not coupled, while the male insert **CQ4M 03** in this circumstance is protected from access with the back of the hand (IP1X or IPXXA)

☑ cannot be used in angled enclosures (IA/IAP/VA version)

- characteristics according to EN 61984:

40 A 400 V 6 kV 3

- cULus (UL for USA and Canada), BUREAU VERITAS, DNV-GL certified

- insulation resistance: ≥ 10 GΩ
- ambient temperature limit: -40 °C ... +125 °C
- made of self-extinguishing thermoplastic resin UL 94V-0
- mechanical life: ≥ 5 000 cycles
- contact resistance: ≤ 0,3 mΩ

- it is recommended to crimp the contacts with crimping tools homologated by ILME (please see the crimping tool section 40 A contacts RX series, pages 708 - 741 on CN.19 catalogue)

- for max. current load see the connector inserts derating diagram below; for more information see page 28 of CN.19 catalogue

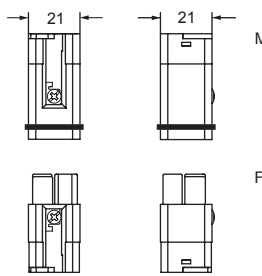

contacts side (front view)

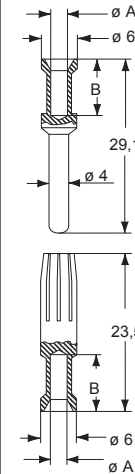

RXF2D and RXM2D contacts

conductor cross-sectional area mm ²	conductor slot ø A (mm)	conductor stripping length B (mm)
1,5	1,8	9
2,5	2,2	9
4	2,85	9,6
6	3,5	9,6

CQ4 03 poles connector inserts
Maximum current load derating diagram

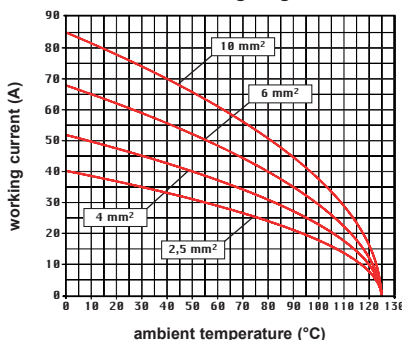

Coding pins
CR Q03, 4 possible
positions
(refer to CN.19,
page 692)



T-TYPE ENCLOSURES SERIES

DUST PROTECTION COVER SIZE “44.27”



The protection of connectors also includes accessories.

In order to **protect wired T-TYPE hoods from dust and particles** which may deposit during transportation, the **new TCP 06 size “44.27” dust protection cover** is now available.

This new disposable plastic cover joins the already existing, but more expensive, regular T-TYPE covers TCHC 06 L (eyelet cord) / SL (loop cord) and TCHC 06 LG (with lever and gasket).

☑ NOTE – For other sizes, only for consistently large quantities, please contact ILME Commercial Offices.

- 🔍 This cover serves both hoods and housings of the same size of series T-TYPE (any kind, including standard T-TYPE, T-TYPE /W, T-TYPE Hygienic, either /H or /C).
- 🔍 Made by **recyclable polypropylene** (>PP< symbol on the piece), it fits with slight friction around the perimeter of the hood. Fixing around the hood is achievable by means of a plastic cable tie (not provided), for which suitable holding seats are provided centrally along long sides.



Find out more
www.ilme.com

T-TYPE DUST PROTECTION COVER SIZE "44.27"

enclosures:
size "44.27"

page:

T-TYPE IP65 insulating	480 - 481
T-TYPE / W IP66/IP69 insulating	489
HYGIENIC T-TYPE / H IP66/IP69	501
HYGIENIC T-TYPE / C IP66/IP69, -50 °C	506

Dust protection cover size "44.27"



FROM MARCH 2022

refer to CN.19 pages

description

part No.

Plastic transparent dust protection cover

TCP 06

- disposable plastic cover to avoid dust deposits during transportation/idle time
- made of transparent >PP< (marked on the inside for recycling purposes)
- cheaper than standard cover
- special ribs for fastening with cable tie (not provided)

NOTE: to be used with T-TYPE enclosures size "44.27" only.

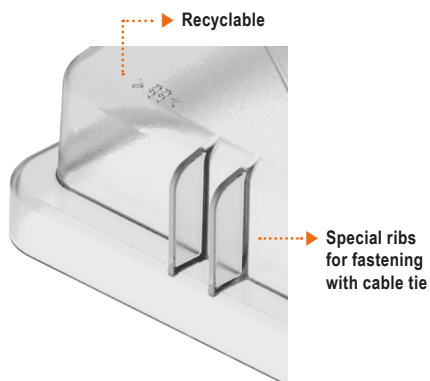
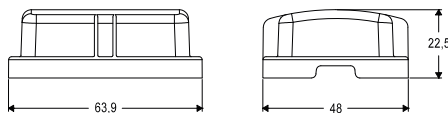

RX7 SERIES FINGERPROOF MALE CRIMP CONTACTS

HNM VERSION WITH INSULATING CAP

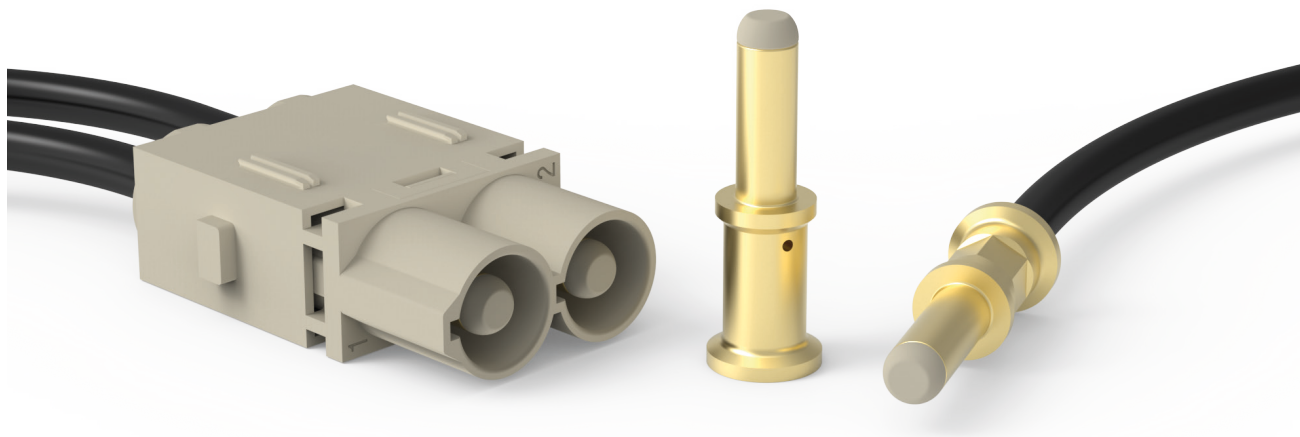

MIXO module **CX 02 7M**, when mounted in dedicated HNM MIXO is used in combination with the **RX7 HNM** series of 70 A crimp contacts which is now expanded by adding a variant of **male contacts with insulating cap** on their tip, to determine the **fingerproof safety** (IPXXB or IP20) feature.

This feature is particularly advantageous in all applications where male connector inserts feed electric motors equipped with power drives, such drives being often equipped motor side with **capacitors** that may remain charged with hazardous voltage present on the pin contacts of the connector for a few times after switching off the motor and unplugging the connector.

NOTE – The new **HNM** crimp combined connector inserts **RXM 4/2** and **RXM 4/8** for use with **RX7** power male crimp contacts and **RC** auxiliary male crimp contacts, cannot take advantage of **RX7M2D..P** fingerproof contacts, in that these inserts, for legacy with the traditional screw-type models, could not be provided with shrouded seats for male contacts as in **MIXO CX 02 7M**.

- Q Tip made by polycarbonate (same as those of the inserts), light grey colour.
- Q All other features are in common with RX7 contacts (i.e., crimping tools, dimensions, materials, etc.).
- Q RoHS: compliant with exemption 6(c).



Find out more
www.ilme.com

inserts:
MIXO (CX 02 7M)

page:
266

70 A HNM gold plated fingerproof male crimp contacts

removal tools

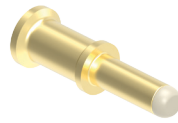

refer to CN.19 pages

FROM MARCH 2022

description	part No.	part No.
-------------	----------	----------

70 A HNM fingerproof male crimp contacts

6 mm ²	(Class 5)	AWG 10
10 mm ²	(Class 5)	AWG 8 - 7
16 mm ²	(Class 5)	AWG 6 - 5
16 mm ²	(Class 6)	AWG 6 - 5
25 mm ²	(Class 5)	AWG 4 - 3

RX7M2D 6.0 P
RX7M2D 10 P
RX7M2D 16 P
RX7M2D 16XFP
RX7M2D 25 P

gold plated

removal tools
for RC series contacts

CX7ES

it is recommended to crimp the contacts with crimping tools homologated by ILME (please see the crimping tool section 70 A contacts, RX7 series) on pages 720 - 721 of CN.19 catalogue

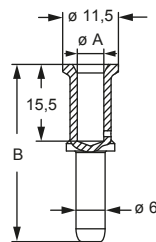

RX7M2D..P contacts

section (mm ²)	ø A (mm)	B (mm)	stripping length (mm)
6	3,5	36,6	15
10	4,3	35,8	15
16	5,5	35,8	15
16 (XF)	6,1	35,8	15
25	7,0	35,8	15





C

CC 0.5 AN	37
CC 0.7 AN	37
CC 1.0 AN	37
CC 1.5 AN	37
CC 2.5 AN	37
CCFA 0.3.....	37
CCFA 0.5.....	37
CCFA 0.7.....	37
CCFA 1.0.....	37
CCFA 1.5.....	37
CCFA 2.5.....	37
CCFA 3.0.....	37
CCFA 4.0.....	37
CCFD 0.3.....	37
CCFD 0.5.....	37
CCFD 0.7.....	37
CCFD 1.0.....	37
CCFD 1.5.....	37
CCFD 2.5.....	37
CCFD 3.0.....	37
CCFD 4.0.....	37
CCMA 0.3.....	37
CCMA 0.5.....	37
CCMA 0.7.....	37
CCMA 1.0.....	37
CCMA 1.5.....	37
CCMA 2.5.....	37
CCMA 3.0.....	37
CCMA 4.0.....	37
CCMD 0.3.....	37
CCMD 0.5.....	37
CCMD 0.7.....	37
CCMD 1.0.....	37
CCMD 1.5.....	37
CCMD 2.5.....	37
CCMD 3.0.....	37
CCMD 4.0.....	37
CDF 08	83
CDM 08	83
CKR 65.....	78*
CKR 65 D	78*
CLI 06 L.....	42
CLI 06 LS	42
CLI 10	44
CLI 16	46
CLI 24	48
CQ4F 03.....	85
CQ4M 03	85

CQA 08 I.....	38
CQF 08E.....	37
CQF 21	82
CQM 08E.....	37
CQM 21	82
CQYF 05.....	19
CQYF 08E	20, 36
CQYM 05.....	19
CQYM 08E	20, 36
CR Q08E.....	21, 39
CX 01 YAF.....	26
CX 01 YAM.....	26
CX 06 CYF	22
CX 06 CYM.....	22
CX7ES	71*
CX 08 CYF	23
CX 08 CYM.....	23

M

MLAP 06 L25	42
MLAP 06 L32	42
MLAP 06 L40	42
MLAP 06 L225	42
MLAP 06 L232	42
MLAP 06 L240	42
MLAP 06 LS32.....	42
MLAP 06 LS40.....	42
MLAP 06LS232.....	42
MLAP 06LS240.....	42
MLAP 10.25	44
MLAP 10.32	44
MLAP 10.40	44
MLAP 10.225	44
MLAP 10.232	44
MLAP 10.240	44
MLAP 16.25	46
MLAP 16.32	46
MLAP 16.40	46
MLAP 16.225	46
MLAP 16.232	46
MLAP 16.240	46
MLAP 24.25	48
MLAP 24.32	48
MLAP 24.40	48
MLAP 24.225	48
MLAP 24.232	48
MLAP 24.240	48
MLAV 06 LG25.....	43

MLAV 06 LG32.....	43
MLAV 10 G25.....	45
MLAV 10 G32.....	45
MLAV 10 G40.....	45
MLAV 16 G25.....	47
MLAV 16 G32.....	47
MLAV 16 G40.....	47
MLAV 24 G25.....	49
MLAV 24 G32.....	49
MLAV 24 G40.....	49
MLFO 06 LG40	43
MLFO 10 G40.....	45
MLFO 16 G40.....	47
MLFO 24 G40.....	49
MLFV 06 LG25.....	43
MLFV 06 LG32.....	43
MLFV 06 LG40.....	43
MLFV 10 G25.....	45
MLFV 10 G32.....	45
MLFV 10 G40.....	45
MLFV 16 G25.....	47
MLFV 16 G32.....	47
MLFV 16 G40.....	47
MLFV 24 G25.....	49
MLFV 24 G32.....	49
MLFV 24 G40.....	49
MLP 06 L20.....	42
MLP 06 L220.....	42
MLP 06 LS20	42
MLP 06 LS220	42
MLP 10.20	44
MLP 10.220	44
MLP 16.225.....	46
MLP 24.25.....	48
MLP 24.225.....	48
MLV 06 LG25.....	43
MLV 10 G25	45
MLV 16 G32	47
MLV 24 G32	49
MQA 08 O25	38
MQA 08 V25.....	38

R

RCF2D 0.3.....	71*
RCF2D 0.5.....	71*
RCF2D 0.7.....	71*
RCF2D 1.0.....	71*
RCF2D 1.5.....	71*

* These items are also shown in various sections throughout the catalogue

RCF2D 2.5.....	71*
RCF2D 3.0.....	71*
RCF2D 4.0.....	71*
RCM2D 0.3.....	71*
RCM2D 0.5.....	71*
RCM2D 0.7.....	71*
RCM2D 1.0.....	71*
RCM2D 1.5.....	71*
RCM2D 2.5.....	71*
RCM2D 3.0.....	71*
RCM2D 4.0.....	71*
RDF2D 0.3.....	83
RDF2D 0.5.....	83
RDF2D 0.7.....	83
RDF2D 1.0.....	83
RDF2D 1.5.....	83
RDF2D 2.5.....	83
RDM2D 0.3.....	83
RDM2D 0.5.....	83
RDM2D 0.7.....	83
RDM2D 1.0.....	83
RDM2D 1.5.....	83
RDM2D 2.5.....	83
RIFD 0.2.....	82
RIFD 0.3.....	82
RIFD 0.5.....	82
RIMD 0.2.....	82
RIMD 0.3.....	82
RIMD 0.5.....	82
RKAX 03 I.....	78
RKAX 03 IA.....	78
RKAX 03 IA4.....	78
RKAX AP20.....	80
RKAX AP25.....	80
RKAX IAF20.....	81
RKAX IAF25.....	81
RKAX IAP20.....	80
RKAX IAP25.....	80
RKAX IF.....	81
RKAX IFC.....	81
RKAX VG20.....	79
RKAX VG25.....	79
RQF 05.....	84
RQM 05.....	84
RX7F2D 6.0.....	70, 74
RX7F2D 10.....	70, 74
RX7F2D 16.....	70, 74
RX7F2D 16 XF.....	70, 74
RX7F2D 25.....	70, 74
RX7M2D 6.0.....	70, 74
RX7M2D 6.0 P.....	89

RX7M2D 10.....	70, 74
RX7M2D 10 P.....	89
RX7M2D 16.....	70, 74
RX7M2D 16 P.....	89
RX7M2D 16 XF.....	70, 74
RX7M2D 16XFP.....	89
RX7M2D 25.....	70, 74
RX7M2D 25 P.....	89
RXCF 4/2.....	70
RXCF 4/8.....	74
RXCM 4/2.....	70
RXCM 4/8.....	74
RXF2D 1.5.....	85
RXF2D 2.5.....	85
RXF2D 4.0.....	85
RXF2D 6.0.....	85
RXM2D 1.5.....	85
RXM2D 2.5.....	85
RXM2D 4.0.....	85
RXM2D 6.0.....	85

T

TAPC 06 L25.....	60
TAPC 06 L32.....	60
TAPC 10.25.....	62
TAPC 10.32.....	62
TAPC 16.32.....	64
TAPC 16.40.....	64
TAPC 24.32.....	66
TAPC 24.40.....	66
TAPH 06 L25.....	52
TAPH 06 L32.....	52
TAPH 10.25.....	54
TAPH 10.32.....	54
TAPH 16.32.....	56
TAPH 16.40.....	56
TAPH 24.32.....	58
TAPH 24.40.....	58
TAVC 06 LG25.....	61
TAVC 06 LG32.....	61
TAVC 10 G25.....	63
TAVC 10 G32.....	63
TAVC 16 G32.....	65
TAVC 16 G40.....	65
TAVC 24 G32.....	67
TAVC 24 G40.....	67
TAVH 06 LG25.....	53
TAVH 06 LG32.....	53
TAVH 10 G25.....	55

TAVH 10 G32.....	55
TAVH 16 G32.....	57
TAVH 16 G40.....	57
TAVH 24 G32.....	59
TAVH 24 G40.....	59
TCHC 06 L.....	53, 61
TCHC 06 SL.....	53, 61
TCHC 10.....	55, 63
TCHC 10 S.....	55, 63
TCHC 16.....	57, 65
TCHC 16 S.....	57, 65
TCHC 24.....	59, 67
TCHC 24 S.....	59, 67
TCP 06.....	87
THCC 06 LG.....	61
THCC 10 G.....	63
THCC 16 G.....	65
THCC 24 G.....	67
THCH 06 LG.....	53
THCH 10 G.....	55
THCH 16 G.....	57
THCH 24 G.....	59
THIC 06 L.....	60
THIC 10.....	62
THIC 16.....	64
THIC 24.....	66
THIH 06 L.....	52
THIH 10.....	54
THIH 16.....	56
THIH 24.....	58
TMAO 06 L25.....	52, 60
TMAO 06 L32.....	52, 60
TMAO 10.25.....	54, 62
TMAO 10.32.....	54, 62
TMAO 16.32.....	56, 64
TMAO 16.40.....	56, 64
TMAO 24.32.....	58, 66
TMAO 24.40.....	58, 66
TMAV 06 L25.....	52, 60
TMAV 06 L32.....	52, 60
TMAV 10.25.....	54, 62
TMAV 10.32.....	54, 62
TMAV 16.32.....	56, 64
TMAV 16.40.....	56, 64
TMAV 24.32.....	58, 66
TMAV 24.40.....	58, 66

* These items are also shown in various sections throughout the catalogue

Worldwide Sales Organization

Headquarters

ILME S.p.A.

Via M.A. Colonna, 9
20149 Milano, Italia
T +39 0234560522
info@ilme.com

France

ILME FRANCE S.A.R.L.

431 rue Roland Garros
Parc d'Activités de l'Aéroport
42160 Andrézieux-Bouthéon
T +33 04 7736 2336
ilme-france@ilme.fr

Sweden

and Nordic Countries

ILME NORDIC AB

Transportvägen 18
246 42 Löddeköpinge
T +46 4618 2800
info@ilme.se

Czech Republic

Representative Office

ILME S.p.A.

Business Center Rokytká
Sokolovská 270/201
Vysocany, Praha 9, 190 00
info@ilme.cz

Japan

ILME JAPAN CO. LTD.

K.I.B.C. Bldg 5-2
Minatojima Minamimachi 5-Chome
Chuo-Ku, Kobe 650-0047
T +81 78 302 2005
info@ilmejapan.co.jp

Germany

ILME GmbH

Max-Planck-Straße 12
51674 Wiehl
T +49 (0)2261 7955 0
technik@ilme.de

United Kingdom

ILME UK LIMITED

50 Evans Road, Venture Point
Speke, Liverpool L24 9PB
T +44 0151 336 9321
sales@ilmeuk.co.uk

China

ILME CHINA CO. LTD.

Room 101, Building 3
188 Xinjunhuan Road, Minhang
Shanghai 201114
T +86 21 6248 9961
info@ilmechina.com

South Korea

ILME KOREA CO.

714, DaeRyung Technotown 20th
5 Gasan Digital 1-Ro, GeumCheon-Gu
Seoul 08594
T +82-2-2225-8432
sales@ilme.kr

www.ilme.com



ILME S.p.A.
Via M.A. Colonna 9
20149 Milano, Italy
www.ilme.com

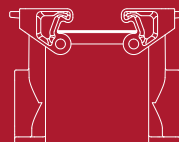
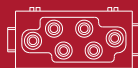
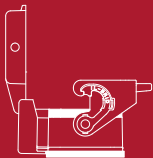
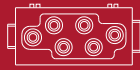
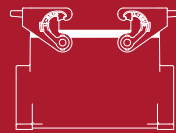
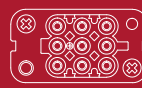
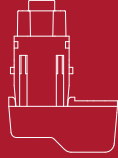
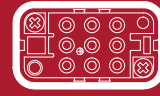

XD6PD22 522



catalogues